



# Acoustic Electric Guitar

## Owner's Manual

Thank you for choosing a Yamaha electric-acoustic guitar.  
In order to make the most of the advanced features and performance provided by your guitar, please read this manual carefully before using the instrument.

### PRECAUTIONS

#### PLEASE READ CAREFULLY BEFORE PROCEEDING

Please keep this manual in a safe and handy place for future reference.

#### WARNING

Always follow the basic precautions listed below to avoid the possibility of serious injury or even death from electrical shock, short-circuiting, damages, fire or other hazards. These precautions include, but are not limited to, the following:

##### Do not open

- This instrument contains no user-serviceable parts. Do not open the instrument or attempt to disassemble or modify the internal components in any way. If it should appear to be malfunctioning, discontinue use immediately and have it inspected by qualified Yamaha service personnel.

##### Water warning

- Do not expose the instrument to rain, use it near water or in damp or wet conditions, place it on any containers (such as vases, bottles, or glasses) containing liquids that might spill into any openings. If any liquid such as water seeps into the instrument, turn off the power immediately and have the instrument inspected by qualified Yamaha service personnel.

##### If you notice any abnormality

- When one of the following problems occur, immediately turn off the power and remove all batteries from the instrument, then have the instrument inspected by Yamaha service personnel.
  - It emits unusual smells or smoke.
  - Some object has been dropped into the instrument.
  - There is a sudden loss of sound during use of the instrument.

#### CAUTION

Always follow the basic precautions listed below to avoid the possibility of physical injury to you or others, or damage to the instrument or other property. These precautions include, but are not limited to, the following:

##### Connection

- Before connecting the instrument to other electronic components, turn off the power for all components. Before turning the power on or off for all components, set all volume levels to minimum.
- Be sure to set the volumes of all components at their minimum levels and gradually raise the volume controls while playing the instrument to set the desired listening level.

##### Location

- Do not place the instrument in an unstable position where it might accidentally fall over.

##### Handling caution

- Do not rest your weight on, or place heavy objects on the instrument, and do not use excessive force on the buttons, switches or connectors.
- Do not use the instrument/device or headphones for a long period of time at a high or uncomfortable volume level, since this can cause permanent hearing loss. If you experience any hearing loss or ringing in the ears, consult a physician.

- \* Yamaha cannot be held responsible for damage caused by improper use or modifications to the instrument, or data that is lost or destroyed.
- \* Information on the battery can be found in the section at the end of this sheet.
- \* Please read the instruction manual for the external audio device such as a guitar amplifier, etc., prior to use.

### BATTERY REPLACEMENT

As battery power becomes low, the battery check indicator will light. Replace the batteries as soon as possible.

- Press the release lever on the battery case in the direction indicated by the arrow ↓ in the illustration in order to unlock it, and then slide out the battery holder.
- Remove the old batteries from the battery holder, and insert the two new size AA alkaline batteries. Make sure that the poles on the batteries are properly positioned as shown in the diagram inside of the holder.
- Slide the battery holder back into the battery case and press firmly so that the battery holder locks in place.

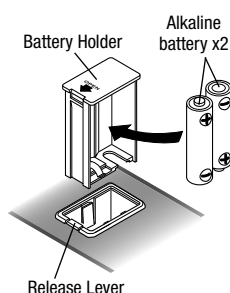

### NOMENCLATURE/THE CONTROLS

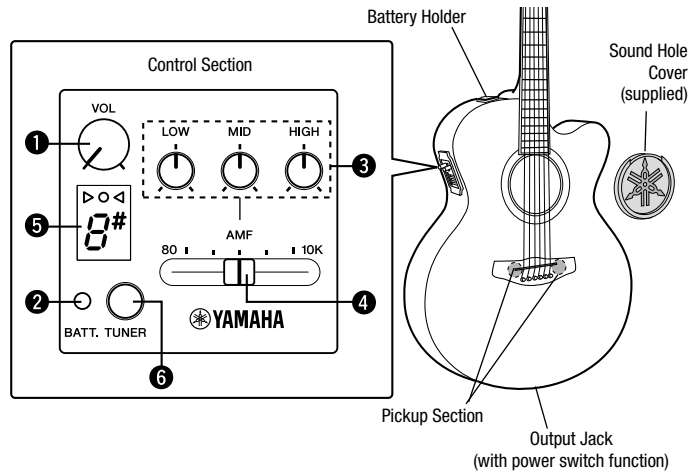

The built-in preamplifier is automatically turned ON when a guitar cable is connected to the output jack.

- VOL Control** Controls the volume.

\* Always set the volume to its minimum level when connecting or disconnecting the cable.

- BATT. (Battery Check) Indicator**

This indicator will light when the battery needs to be replaced. Please replace the battery as soon as possible when the BATT. indicator lights.

\* The battery check indicator may light momentarily when the TUNER switch is pressed. This is not a sign however, that the battery power is low.

- 3-Band Equalizer**

**LOW** : Boosts or cuts the level of the low frequencies.

**MID** : Boosts or cuts the level of the middle frequencies. The AMF control ④ adjusts the center frequency of the band affected by this control.

**HIGH** : Boosts or cuts the level of the high frequencies.

- AMF Control**

Sets the center frequency of the band of frequencies affected by the MID equalizer control. The range is from 80 Hz to 10 kHz.

\* This control has no effect when the MID equalizer control is set to its center position.

- Tuner Display** Displays tuner information.

- TUNER Switch** Switches the tuner ON/OFF.

#### Using the Sound Hole Cover

If feedback occurs when playing at high volumes, the Sound Hole Cover should be inserted into the sound hole. When inserted into the sound hole, Sound Hole Cover effectively reduces feedback.

### USING THE TUNER

- Press and hold the TUNER switch until the ▷ ◯ ◁ display lights to switch the tuner power ON.
- Tune the guitar string until the note name of the desired pitch appears in the display.
- The string is in tune when only the ◯ lamp lights in the center of the ▷ ◯ ◁ display.



- Press the TUNER switch again to switch the tuner power OFF. Also, if the note name is not shown in the display for more than 1 minute, the power will automatically switch OFF. (▷ ◯ ◁ display goes off)

\* It may take a few seconds before the tuner can detect pitches after being switched ON.











\* The note name and ▷ ◯ ◁ displays may have difficulty keeping up with irregular pitch changes. Gradually change the pitch and check when tuning.

\* The tuner may not be able to detect notes rich with overtones or with very short sustain.

\* Sound output is not muted when the tuner is being used.

### SPECIFICATIONS

- **System:** System-64
- **Pickup:** Contact Pickup (installed inside of the body)
- **Preamplifier Controls:** Vol., 3-Band EQ (HIGH, MID, LOW), AMF control, TUNER
- **Output Jack:** Combination end pin/power switch
- **Output Impedance:** 1kΩ
- **Batteries:** Size AA alkaline battery (LR6) x2
- **Battery Life:** Approx. 180 hours (Without tuner and using alkaline batteries. May differ due to operating conditions.)
- **Tuner:** Chromatic type (12 semi-tones), A4=440Hz, Accuracy range +/- 3 cents
- **Accessories:** Neck adjustment hex-wrench x1, Sound hole cover x1

 <b>警告</b>	
この表示内容を見逃した取り扱いをすると、死亡や重症を負う可能性が想定されます。	
電池	
 電池を分解しない。	 長時間使用しない場合や電池を使い切った場合は、電池を本体から抜いておく。
 電池を火の中に入れてはいけない。	 電池は子供の手の届くところに置かない。
 使い切りタイプの電池は、充電しない。	 電池を金属製のネックレスやヘアピン、コイン、鍵などと一緒を持ち運んだり保管しない。
 指定以外の電池を使用しない。	 電池が液漏れした場合は、漏れた液に触れない。万一液が目や口に入ったり皮膚に付いたりした場合は、すぐに水で洗い流し、医師に相談してください。
 複数の電池を使う場合、同じメーカーの同じ種類、同じ品番の新しい電池を使用する。	
 電池はすべて+/-の極性表示どおりに正しく入れる。	

・使用済みの乾電池は、各自自治体で決められたルールに従って廃棄しましょう。

## **AG-Stomp の電源供給機能に関するご注意**

本ギターは弊社多機能プリアンプ AG-Stomp の電源供給機能には対応しておりません。電源供給機能を使用しますと、本ギターの内蔵プリアンプ内の回路が破損し、音出力・チューナー機能等に支障をきたすおそれがあります。

※ AG-Stomp に接続する場合は、電源供給機能を OFF (+9V SUPPLY スイッチを OFF) にし、本ギターのバッテリーホルダーに電池を挿入した状態でお使いください。

## **WARNING**

Always follow the basic precautions listed below to avoid the possibility of serious injury or even death from electrical shock, short-circuiting, damages, fire or other hazards. These precautions include, but are not limited to, the following:

### Battery

- Follow the precautions below. Failure to do so might result in explosion, fire, overheating or battery fluid leakage.
  - Do not tamper with or disassemble batteries.
  - Do not dispose of batteries in fire.
  - Do not attempt to recharge batteries that are not designed to be charged.
  - Keep the batteries separate from metallic objects such as necklaces, hairpins, coins, and keys.
  - Use the specified battery type only.
  - Use new batteries, all of which are the same type, same model, and made by the same manufacturer.
  - Always make sure all batteries are inserted in conformity with the +/- polarity markings.
  - When the batteries run out, or if the instrument is not to be used for a long time, remove the batteries from the instrument.
- Do not carry or store batteries with other metal objects such as necklaces, hairpins, metal coins, or keys.
- If the batteries do leak, avoid contact with the leaked fluid. If the battery fluid should come in contact with your eyes, mouth, or skin, wash immediately with water and consult a doctor. Battery fluid is corrosive and may possibly cause loss of sight or chemical burns.

Make sure to discard used batteries according to local regulations.

## **Caution!**

Regarding the AG-Stomp Guitar Power Supply Function

This guitar is not compatible with the power supply function on the AG-Stomp acoustic guitar preamplifier. Using the guitar power supply function on the AG-Stomp can damage the guitar's built-in preamplifier resulting in abnormal sound output, tuner operation, etc.

\* Before connecting the guitar to the AG-Stomp, make sure that the AG-Stomp's guitar power supply function is switched OFF (switch OFF the +9V SUPPLY switch) and insert a battery into the guitar's battery holder.

## **AVERTISSEMENT**

Veillez à toujours observer les précautions élémentaires énumérées ci-après pour éviter de graves blessures, voire la mort, en raison d'une électrocution, d'un court-circuit, de dégâts, d'un incendie ou de tout autre risque. La liste de ces précautions n'est pas exhaustive :

### Piles

- Veillez à respecter les précautions détaillées ci-après. Le non respect de ces instructions risque de provoquer une explosion, un incendie ou une fuite du liquide des piles.
  - N'altérez pas les piles et n'essayez pas de les démonter.
  - Ne jetez pas les piles au feu.
  - Ne tentez pas de recharger une pile non rechargeable.
  - Gardez les piles éloignées des objets métalliques tels que les colliers, les épingles à cheveux, les pièces de monnaie ou les clés.
  - Utilisez uniquement le type de pile spécifié.
  - Veillez à utiliser des piles neuves, de type et de modèle identiques, issues du même fabricant.
  - Prenez soin de respecter la polarité (+/-) lors de la mise en place des piles.
  - Lorsque les piles sont épuisées ou en cas de non-utilisation de l'instrument pendant une durée prolongée, retirez les piles de l'instrument.
- Conservez les piles hors de portée des enfants car ceux-ci risquent de les avaler.
- En cas de fuite du liquide des piles, évitez tout contact avec ce liquide. En cas de contact avec les yeux, la bouche ou la peau, rincez immédiatement à l'eau claire et consultez un médecin. Le liquide présent dans la pile est corrosif et peut provoquer la cécité ou des brûlures chimiques.

Veiller à éliminer les piles usagées selon les réglementations locales.

## **Attention !**

À propos de la fonction d'alimentation électrique de la guitare du AG-Stomp

La guitare n'est pas compatible avec la fonction d'alimentation électrique du préamplificateur de guitare acoustique AG-Stomp. L'utilisation de cette fonction sur l'AG-Stomp peut endommager le préamplificateur intégré de la guitare, ce qui nuit à la qualité du son, au fonctionnement de l'accordeur, etc.

\* Avant de raccorder la guitare à l'AG-Stomp, assurez-vous que la fonction d'alimentation électrique de guitare de l'AG-Stomp est désactivée (commutateur +9V SUPPLY en position OFF) et introduisez une pile dans le porte-pile de la guitare.

## **AVVERTENZA**

Attenersi sempre alle precauzioni di base indicate di seguito per evitare il rischio di lesioni gravi o addirittura di morte conseguente a scosse elettriche, cortocircuiti, danni, incendi o altri pericoli. Tali precauzioni includono, fra le altre, quelle indicate di seguito:

### Batteria

- Attenersi alle precauzioni indicate di seguito. In caso contrario, si potrebbero causare esplosioni, incendi, surriscaldamento o fuoriuscite di liquido dalle batterie.
  - Non manomettere né disassemblare le batterie.
  - Non smaltire le batterie nel fuoco.
  - Non ricaricare batterie non ricaricabili.
  - Tenere le batterie lontane da oggetti metallici come collane, fermacapelli, monete e chiavi.
  - Utilizzare solo il tipo di batterie specificato.
  - Utilizzare batterie nuove, tutte dello stesso tipo, modello e produttore.
  - Assicurarsi che tutte le batterie siano inserite nel rispetto delle indicazioni di polarità +/-.
  - In caso di esaurimento delle batterie o se si prevede di non utilizzare lo strumento per molto tempo, rimuovere le batterie dallo strumento.
- Conservare le batterie lontano dalla portata dei bambini, che potrebbero ingerirle accidentalmente.
- In caso di fuoriuscite, evitare il contatto con il liquido delle batterie. Se il liquido delle batterie viene a contatto con gli occhi, la bocca o la cute, lavare immediatamente con acqua e rivolgersi a un medico. Il liquido delle batterie è corrosivo e potrebbe causare la perdita della vista o ustioni chimiche.

Smaltire le batterie esauste in conformità alle normative locali.

## **Attenzione!**

Funzione di alimentazione della chitarra AG-Stomp

Questa chitarra non è compatibile con la funzione di alimentazione del preamplificatore per chitarra acustica YAMAHA AG-Stomp. Usando la funzione di alimentazione della chitarra AG-Stomp si può danneggiare il preamplificatore incorporato della chitarra, producendo suoni ed un funzionamento dell'accordatore anormali, ecc.

\* Prima di collegare la chitarra all'AG-Stomp, controllare che la funzione di alimentazione della chitarra AG-Stomp sia spenta (portando su OFF l'interruttore +9V SUPPLY) ed inserire una batteria nel vano batteria della chitarra.

## **WARNUNG**

Beachten Sie stets die nachstehend aufgelisteten Vorsichtsmaßnahmen, um mögliche schwere Verletzungen oder sogar tödliche Unfälle infolge eines elektrischen Schlags, von Kurzschlüssen, Feuer oder anderen Gefahren zu vermeiden. Zu diesen Vorsichtsmaßnahmen gehören die folgenden Punkte, die jedoch keine abschließende Aufzählung darstellen:

### **Batterien**

- Beachten Sie die folgenden Vorsichtsmaßnahmen. Bei Missachtung der Maßnahmen könnte es zu einer Explosion oder einem Brand kommen oder Batterieflüssigkeit auslaufen.
  - Manipulieren Sie Batterien nicht und nehmen Sie sie nicht auseinander.
  - Werfen Sie Batterien nicht ins Feuer.
  - Versuchen Sie niemals, Batterien aufzuladen, die nicht zum mehrfachen Gebrauch und Nachladen vorgesehen sind.
  - Bewahren Sie die Batterien nicht zusammen mit metallischen Gegenständen wie Halsketten, Haarnadeln, Münzen und Schlüsseln auf.
  - Verwenden Sie ausschließlich den angegebenen Batterietyp.
  - Verwenden Sie neue Batterien, die alle vom gleichen Typ, Modell und Hersteller sind.
  - Vergewissern Sie sich stets, dass alle Batterien gemäß den Polaritätskennzeichnungen (+/-) eingelegt sind.
  - Wenn die Batterien leer sind oder Sie das Instrument längere Zeit nicht nutzen werden, entnehmen Sie die Batterien aus dem Instrument.
- Halten Sie Batterien von kleinen Kindern fern, die sie versehentlich verschlucken könnten.
- Wenn die Batterien leak sind, vermeiden Sie jede Berührung mit der ausgetretenen Flüssigkeit. Wenn die Batterieflüssigkeit mit Augen, Mund oder Haut in Kontakt kommt, bitte sofort mit Wasser auswaschen und einen Arzt aufsuchen. Batterieflüssigkeit ist ätzend und kann zum Verlust des Augenlichts oder zu chemischen Verbrennungen führen.

**Achten Sie darauf, dass gebrauchte Batterien den geltenden Bestimmungen gemäß entsorgt werden.**



### **Vorsicht!**

### **Wichtiger Hinweis zur AG-Stomp-Stromversorgung für Gitarren**

Diese Gitarre ist nicht mit der Stromversorgungsfunktion des Akustik-Gitarren-Vorverstärkers AG-Stomp kompatibel. Bei Anschluss an die Stromversorgung des AG-Stomp kann der interne Vorverstärker der Gitarre Schaden nehmen, was anormalen Klang und Störungen der Stimmgerätfunktion zur Folge hat.

\* Bevor Sie die Gitarre anschließen, schalten Sie den AG-Stomp aus (+9V SUPPLY-Schalter auf „OFF“) und legen eine Batterie in den Batteriehalter der Gitarre ein.

## **ADVERTENCIA**

Siga siempre las precauciones básicas detalladas a continuación para prevenir la posibilidad de lesiones graves, o incluso la muerte, por descargas eléctricas, cortocircuitos, daños, incendios u otros peligros. Estas precauciones incluyen, aunque no de forma exclusiva, las siguientes:

### **Pilas**

- Tenga en cuenta las advertencias que se indican a continuación. Si no fuera así, podría producirse una explosión, un incendio, un recalentamiento o fugas.
  - No manipule ni desmonte las pilas.
  - No tire pilas al fuego.
  - No intente recargar pilas que no sean recargables.
  - Mantenga las pilas separadas de objetos metálicos como collares, horquillas, monedas y llaves.
  - Utilice el tipo de pila especificado.
  - Utilice pilas nuevas, todas del mismo tipo, del mismo modelo y del mismo fabricante.
  - Asegúrese siempre de que todas las pilas estén colocadas conforme a las marcas de polaridad +/-.
  - Cuando se agoten las pilas o no se vaya a utilizar el instrumento durante mucho tiempo, quite las pilas del instrumento.
- No deje las pilas cerca de niños pequeños que puedan tragarlas accidentalmente.
- Si las pilas tienen alguna fuga, evite el contacto con el fluido derramado. Si el fluido de la pila entra en contacto con los ojos, la boca o la piel, lávese inmediatamente con agua y consulte a un médico. El fluido de las pilas es corrosivo y puede causar pérdida de visión o quemaduras químicas.

**Asegúrese de desechar las pilas usadas de acuerdo con la normativa local.**



### **¡Precaución!**

### **Acerca de la función de alimentación del AG-Stomp**

Esta guitarra no es compatible con la función de alimentación del preamplificador para guitarra acústica AG-Stomp. El empleo de la función de alimentación de guitarra del AG-Stomp puede causar daños en el preamplificador para guitarra incorporado y producir anomalías en la salida de sonido, operación del afinador, etc.

\* Antes de conectar la guitarra al AG-Stomp, asegúrese de que la función de alimentación de guitarra del AG-Stomp esté desactivada (OFF) (desconecte (OFF) el interruptor +9V SUPPLY) e inserte una pila en el compartimento de la pila de la guitarra.

## **ADVERTÊNCIA**

Sempre observe as precauções básicas descritas a seguir para evitar a possibilidade de sérios ferimentos ou mesmo a morte decorrentes de um choque elétrico, curto-circuito, danos, incêndio ou outros perigos. Estas precauções incluem, entre outros:

### **Pilha**

- Siga as precauções abaixo. Deixar de fazer isso pode provocar uma explosão, incêndio, sobreaquecimento ou vazamento do fluido das pilhas.
  - Não modifique nem desmonte pilhas.
  - Não elimine pilhas ao fogo.
  - Não tente recarregar pilhas que não foram projetadas para serem carregadas.
  - Mantenha as pilhas separadas de objetos metálicos como colares, grampos de cabelo, moedas e chaves.
  - Use apenas o tipo de pilha especificado.
  - Use pilhas novas, todas do mesmo tipo, mesmo modelo, e feitas pelo mesmo fabricante.
  - Certifique-se sempre de instalar todas as pilhas em conformidade com as marcações de polaridade +/-.
  - Quando as pilhas se esgotarem, ou se você não for usar o produto durante um longo período de tempo, retire as pilhas do instrumento.
- Não transporte nem guarde as pilhas com objetos metálicos como colares, grampos de cabelo, moedas ou chaves.
- Se as pilhas vazarem, evite o contato com o fluido vazado. Se o fluido de uma pilha entrar em contato com seus olhos, boca ou pele, lave a parte afetada imediatamente com água e procure um médico. O fluido das pilhas é corrosivo e pode provocar a perda da visão ou queimaduras químicas.

**Certifique-se de eliminar pilhas usadas de acordo com os regulamentos locais.**



### **Atenção!**

### **Sobre a função de fornecimento de energia do pré-amplificador de violão acústico AG-Stomp**

Este violão não é compatível com a função de fornecimento de energia do pré-amplificador de violão acústico AG-Stomp. Usar a função de fornecimento de energia para violão no pré-amplificador AG-Stomp pode danificar o pré-amplificador integrado do violão, resultando numa saída anormal do som, operação incorreta do afinador, etc.

\* Antes de conectar o violão ao pré-amplificador AG-Stomp, certifique-se de que a função de fornecimento de energia para violão do pré-amplificador AG-Stomp esteja desativada (desligue o interruptor +9V SUPPLY) e coloque uma pilha no porta-pilha do violão.



## **ПРЕДУПРЕЖДЕНИЕ**

Во избежание получения серьезных травм вплоть до наступления смерти от удара электрическим током, а также во избежание короткого замыкания, повреждения оборудования, пожара и других инцидентов, всегда соблюдайте основные правила безопасности, перечисленные далее. Они включают принятие следующих мер (не ограничиваясь ими):

### **Батарея**

- Выполняйте указанные ниже меры предосторожности. Несоблюдение этих мер может привести к взрыву, возгоранию, перегреву или вытеканию электролита из батарей.
  - Не портите умышленно и не разбирайте батареи.
  - Не бросайте батареи в огонь.
  - Не пытайтесь перезарядить батареи, не предназначенные для перезарядки.
  - Храните батареи отдельно от металлических предметов, таких как жерелья, заколки, монеты и ключи.
  - Используйте только батареи указанного типа.
  - При применении новых батарей устанавливайте батареи одинакового типа и одинаковой модели, изготовленные одним производителем.
  - Обязательно устанавливайте батареи согласно маркировке, соблюдая полярность.
  - При разрядке батарей или если инструмент не будет использоваться в течение длительного времени, выньте их из инструмента во избежание вытекания электролита.
- Храните батареи в недоступном для детей месте.
- Если батареи все же протекли, избегайте контакта с вытекшим электролитом. В случае попадания электролита в глаза, рот или на кожу, немедленно смойте электролит водой и обратитесь к врачу. Электролит, используемый в батареях, – это агрессивное вещество, способное вызвать потерю зрения или химические ожоги.

**Утилизацию использованных батарей необходимо выполнять в соответствии с действующим местным законодательством.**



### **Внимание!**

### **Относительно функции источника питания гитарного процессора AG-Stomp (процессор эффектов для акустических гитар)**

Данная гитара несовместима с функцией источника питания на акустическом гитарном предусилителе процессора AG-Stomp. Использование функции источника питания гитары на процессоре AG-Stomp может повредить встроенный предусилитель гитары и привести к ненормальному выводу звукового сигнала, нарушению работы тюнера, и т.п.

\* Перед подсоединением гитары к процессору AG-Stomp убедитесь в том, что функция источника питания гитарного процессора AG-Stomp выключена (переключатель ВКЛ/установлен в положение +9V SUPPLY), а затем вставьте батарею в держатель батареи гитары.



## 警告

为了避免因触电、短路、损伤、火灾或其它危险可能导致的严重受伤甚至死亡，请务必遵守下列基本注意事项。这些注意事项包括但不限于下列情况：

### 电池

- 请遵照以下注意事项。否则，可能会导致爆炸、火灾、过热或电池液泄漏。
  - 切勿玩弄或拆卸电池。
  - 请勿将电池丢弃到火中。
  - 请勿试图对非充电电池进行充电。
  - 请使电池远离项链、发夹、硬币和钥匙等金属物件。
  - 只能使用规定的电池类型。
  - 请使用相同类型、相同型号以及由相同厂商生产的新电池。
  - 装入电池时，请务必使其正负极与 +/- 极标记保持一致。
  - 当电池用尽，或者长时间未使用本乐器，请从本乐器中取出电池。
- 请将电池放置在小孩够不到的地方以免其误吞。
- 万一电池发生泄漏，请勿接触泄漏的电解液。万一电解液进入眼睛、嘴，或接触到皮肤，请立即用水冲洗并去看医生。电解液具有腐蚀性，可能致视力丧失或化学灼伤。

请务必根据当地的规定处理废弃的电池。



## 警告！ 关于 AG-Stomp 吉他的电源功能

本吉他不兼容 AG-Stomp 原音吉他前置放大器上的电源功能。使用 AG-Stomp 上的吉他电源功能会损坏吉他的内置前置放大器，从而导致声音输出，调谐器运转异常等后果。

\* 将吉他连接到 AG-Stomp 之前，请确认已关闭 AG-Stomp 的吉他电源功能（将 +9V SUPPLY 开关置于 OFF），并且已将电池插入吉他的电池舱。



该标记附加在出售到中华人民共和国的电子产品信息上。环形中的数字表示的是环境保护使用期限的年数。

### 产品中有害物质的名称及含量

部件名称	有害物质					
	铅 (Pb)	汞 (Hg)	镉 (Cd)	六价铬 (Cr(VI))	多溴联苯 (PBB)	多溴二苯醚 (PBDE)
吉他主机	×	○	○	○	○	○
电装	×	○	○	○	○	○

本表格依据 SJ/T 11364 的规定编制。

○：表示该有害物质在该部件所有均质材料中的含量均在 GB/T 26572 规定的限量要求以下。

×：表示该有害物质至少在该部件的某一均质材料中的含量超出 GB/T 26572 规定的限量要求。

乐器背面或里面的序列号中表示了生产日期

序列号的显示示例

制造年份    制造月份

制造年份：首部的两个字母表示日历年份最后面的两位数字。字母“H”到“P”分别表示“1”到“9”的数字，“0”由字母“Q”表示。

制造月份：从一月到九月，以字母“H”到“P”分别表示，十月至十二月的月份，以字母“X”到“Z”分别表示。

产品上显示了生产日期



## 경고

아래에 열거되어 있는 기본 주의사항을 반드시 준수하여 감전, 누전, 손상, 화재 및 기타 위험으로 인해 부상 및 사망이 발생할 가능성을 줄이시기 바랍니다. 다음과 같은 주의사항들이 있으나 이 사항들에 국한되는 것은 아닙니다.

### 배터리 최적화

- 아래의 안전 주의사항을 준수하십시오. 그렇지 않으면 폭발, 화재가 발생하거나 배터리 액이 누출될 수 있습니다.
  - 배터리를 임의로 조작하거나 분해하지 마십시오.
  - 배터리를 불에 넣지 마십시오.
  - 일회용 배터리는 재충전하지 마십시오.
  - 배터리를 목걸이, 머리핀, 동전, 열쇠등과 같은 금속물체와 가까이 두지 마십시오.
  - 지정된 배터리만 사용하십시오.
  - 새 배터리를 사용할 경우 같은 제조업체에서 만든 동일한 형식의 동일한 모델을 사용하십시오.
  - +/- 극성 표시에 맞춰 배터리를 정확하게 삽입하십시오.
  - 배터리가 완전히 소모된 경우 또는 악기를 장시간 사용하지 않는 경우에는 악기에서 배터리를 빼십시오.
- 사고로 삼킬 수도 있으므로 배터리는 유아의 손이 닿지 않는 곳에 보관하십시오.
- 배터리 액이 누출된 경우 누출된 액체가 손에 닿지 않도록 하십시오. 배터리 액이 누출되어 눈이나 입, 피부에 닿은 경우에는 즉시 물로 씻은 후 의사와 상담하십시오. 배터리 액은 부식성이기 때문에 시력 상실 및 화학적 화상을 야기할 수 있습니다.

배터리는 반드시 해당 지역의 법규에 따라 폐기하십시오.



## 주의! AG-스톱프 기타 전원 공급 기능에 관해서

본 기타는 AG-스톱프 어코스틱 기타 프리앰프의 전원 공급 기능과 호환하지 않습니다. AG-스톱프에서 기타 전원 공급 기능을 사용하면 기타의 내장 프리앰프를 손상시켜서 비정상적인 사운드 출력이나 튠너 조작 등을 유발합니다.

\* AG-스톱프에 기타를 연결하기 전에 AG-스톱프의 기타 전원 공급 기능이 꺼진 것을 확인하고(+9V SUPPLY 스위치를 끄니다), 기타의 배터리 홀더에 배터리를 삽입해 주십시오.

## FCC INFORMATION (U.S.A.)

### 1. IMPORTANT NOTICE: DO NOT MODIFY THIS UNIT!

This product, when installed as indicated in the instructions contained in this manual, meets FCC requirements. Modifications not expressly approved by Yamaha may void your authority, granted by the FCC, to use the product.

### 2. IMPORTANT:

When connecting this product to accessories and/or another product use only high quality shielded cables. Cable/s supplied with this product MUST be used. Follow all installation instructions. Failure to follow instructions could void your FCC authorization to use this product in the USA.

### 3. NOTE:

This product has been tested and found to comply with the requirements listed in FCC Regulations, Part 15 for Class "B" digital devices. Compliance with these requirements provides a reasonable level of assurance that your use of this product in a residential environment will not result in harmful interference with other electronic devices. This equipment generates/uses radio frequencies and, if not installed and used according to the instructions found in the users manual, may cause interference harmful to the operation of other electronic devices. Compliance with FCC regulations does not guarantee that interference

will not occur in all installations. If this product is found to be the source of interference, which can be determined by turning the unit "OFF" and "ON", please try to eliminate the problem by using one of the following measures:

Relocate either this product or the device that is being affected by the interference.

Utilize power outlets that are on different branch (circuit breaker or fuse) circuits or install AC line filter/s.

In the case of radio or TV interference, relocate/reorient the antenna. If the antenna lead-in is 300 ohm ribbon lead, change the lead-in to co-axial type cable.

If these corrective measures do not produce satisfactory results, please contact the local retailer authorized to distribute this type of product. If you can not locate the appropriate retailer, please contact Yamaha Corporation of America, Electronic Service Division, 6600 Orangethorpe Ave, Buena Park, CA90620

The above statements apply ONLY to those products distributed by Yamaha Corporation of America or its subsidiaries.

This device complies with part 15 of the FCC Rules.

Operation is subject to the following two conditions: (1) This device may not cause harmful interference, and (2) this device must accept any interference received, including interference that may cause undesired operation.

### CAN ICES-3 (B)/NMB-3(B)

- This applies only to products distributed by Yamaha Canada Music Ltd.
- Ceci ne s'applique qu'aux produits distribués par Yamaha Canada Musique Ltée. (can\_b\_01)