

**YAMAHA ELECTONE  
CLASSIC ORGAN  
F-400  
OWNER'S MANUAL**

# SPECIAL MESSAGE SECTION

**PRODUCT SAFETY MARKINGS:** Yamaha electronic products may have either labels similar to the graphics shown below or molded/stamped facsimiles of these graphics on the enclosure. The explanation of these graphics appears on this page. Please observe all cautions indicated on this page and those indicated in the safety instruction section.

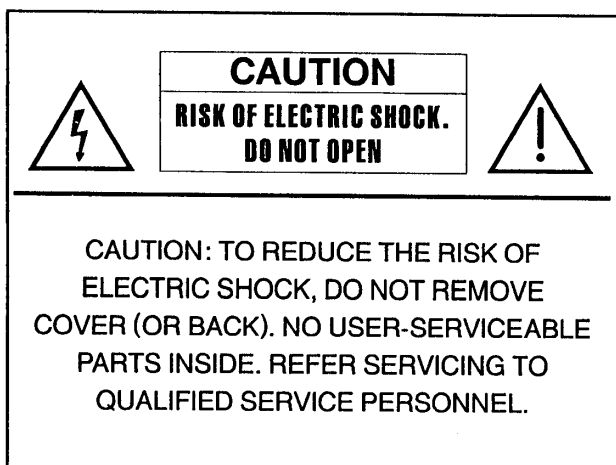

See bottom of keyboard enclosure for graphic symbol markings.



The exclamation point within the equilateral triangle is intended to alert the user to the presence of important operating and maintenance (servicing) instructions in the literature accompanying the product.

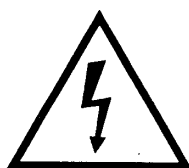

The lightning flash with arrowhead symbol within the equilateral triangle is intended to alert the user to the presence of uninsulated "dangerous voltage" within the product's enclosure that may be of sufficient magnitude to constitute a risk of electrical shock.

**IMPORTANT NOTICE:** All Yamaha electronic products are tested and approved by an independent safety testing laboratory in order that you may be sure that when it is properly installed and used in its normal and customary manner, all foreseeable risks have been eliminated. **DO NOT** modify this unit or commission others to do so unless specifically authorized by Yamaha. Product performance and/or safety standards may be diminished. Claims filed under the expressed warranty may be denied if the unit is/has been modified. Implied warranties may also be affected.

**SPECIFICATIONS SUBJECT TO CHANGE:** The information contained in this manual is believed to be correct at the time of printing. However, Yamaha reserves the right to change or modify any of the specifications without notice or obligation to update existing units.

**ENVIRONMENTAL ISSUES:** Yamaha strives to produce products that are both user safe and environmentally friendly. We sincerely believe that our products and the production methods used to produce them, meet these goals. In keeping with both the letter and the spirit of the law, we want you to be aware of the following:

**Battery Notice:** This product **MAY** contain a small non-rechargeable battery which (if applicable) is soldered in place. The average life span of this type of battery is approximately five years. When replacement becomes necessary, contact a qualified service representative to perform the replacement.

**Warning:** Do not attempt to recharge, disassemble, or incinerate this type of battery. Keep all batteries away from children. Dispose of used batteries promptly and as regulated by applicable laws. Note: In some areas, the servicer is required by law to return the defective parts. However, you do have the option of having the servicer dispose of these parts for you.

**Disposal Notice:** Should this product become damaged beyond repair, or for some reason its useful life is considered to be at an end, please observe all local, state, and federal regulations that relate to the disposal of products that contain lead, batteries, plastics, etc.

**NOTICE:** Service charges incurred due to lack of knowledge relating to how a function or effect works (when the unit is operating as designed) are not covered by the manufacturer's warranty, and are therefore the owners responsibility. Please study this manual carefully and consult your dealer before requesting service.

**NAME PLATE LOCATION:** The graphic below indicates the location of the name plate. The model number, serial number, power requirements, etc., are located on this plate. You should record the model number, serial number, and the date of purchase in the spaces provided below and retain this manual as a permanent record of your purchase.

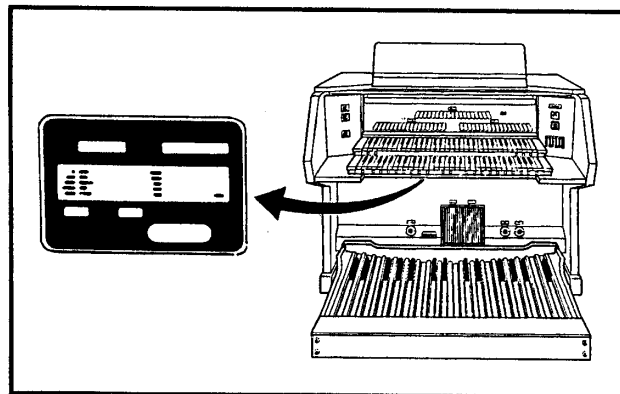

Model \_\_\_\_\_

Serial No. \_\_\_\_\_

Purchase Date \_\_\_\_\_

# IMPORTANT SAFETY INSTRUCTIONS

## INFORMATION RELATING TO PERSONAL INJURY, ELECTRICAL SHOCK, AND FIRE HAZARD POSSIBILITIES HAS BEEN INCLUDED IN THIS LIST.

**WARNING**—When using any electrical or electronic product, basic precautions should always be followed. These precautions include, but are not limited to, the following:

**1.** Read all Safety Instructions, Installation Instructions, Special Message Section items, and any Assembly Instructions found in this manual BEFORE making any connections, including connection to the main supply.

**2.** Main Power Supply Verification: Yamaha products are manufactured specifically for the supply voltage in the area where they are to be sold. If you should move, or if any doubt exists about the supply voltage in your area, please contact your dealer for supply voltage verification and (if applicable) instructions. The required supply voltage is printed on the name plate. For name plate location, please refer to the graphic found in the Special Message Section of this manual.

**3.** This product may be equipped with a polarized plug (one blade wider than the other). If you are unable to insert the plug into the outlet, turn the plug over and try again. If the problem persists, contact an electrician to have the obsolete outlet replaced. Do NOT defeat the safety purpose of the plug.

**4.** Some electronic products utilize external power supplies or adapters. DO NOT connect this type of product to any power supply or adapter other than one described in the owners manual, on the name plate, or specifically recommended by Yamaha.

**5. WARNING:** Do not place this product or any other objects on the power cord or place it in a position where anyone could walk on, trip over, or roll anything over power or connecting cords of any kind. The use of an extension cord is not recommended! If you must use an extension cord, the minimum wire size for a 25' cord (or less) is 18 AWG. NOTE: The smaller the AWG number, the larger the current handling capacity. For longer extension cords, consult a local electrician.

**6.** Ventilation: Electronic products, unless specifically designed for enclosed installations, should be placed in locations that do not interfere with proper ventilation. If instructions for enclosed installations are not provided, it must be assumed that unobstructed ventilation is required.

**7.** Temperature considerations: Electronic products should be installed in locations that do not significantly contribute to their operating temperature. Placement of this product close to heat sources such as; radiators, heat registers and other devices that produce heat should be avoided.

**8.** This product was NOT designed for use in wet/damp locations and should not be used near water or exposed to rain. Examples of wet/damp locations are; near a swimming pool, spa, tub, sink, or wet basement.

**9.** This product should be used only with the components supplied or; a cart, rack, or stand that is recommended by the manufacturer. If a cart, rack, or stand is used, please observe all safety markings and instructions that accompany the accessory product.

**10.** The power supply cord (plug) should be disconnected from the outlet when electronic products are to be left unused for extended periods of time. Cords should also be disconnected when there is a high probability of lightning and/or electrical storm activity.

**11.** Care should be taken that objects do not fall and liquids are not spilled into the enclosure through any openings that may exist.

**12.** Electrical/electronic products should be serviced by a qualified service person when:

- The power supply cord has been damaged; or
- Objects have fallen, been inserted, or liquids have been spilled into the enclosure through openings; or
- The product has been exposed to rain; or
- The product does not operate, exhibits a marked change in performance; or
- The product has been dropped, or the enclosure of the product has been damaged.

**13.** Do not attempt to service this product beyond that described in the user-maintenance instructions. All other servicing should be referred to qualified service personnel.

**14.** This product, either alone or in combination with an amplifier and headphones or speaker/s, may be capable of producing sound levels that could cause permanent hearing loss. DO NOT operate for a long period of time at a high volume level or at a level that is uncomfortable. If you experience any hearing loss or ringing in the ears, you should consult an audiologist. IMPORTANT: The louder the sound, the shorter the time period before damage occurs.

**15.** Some Yamaha products may have benches and/or accessory mounting fixtures that are either supplied as a part of the product or as optional accessories. Some of these items are designed to be dealer assembled or installed. Please make sure that benches are stable and any optional fixtures (where applicable) are well secured BEFORE using. Benches supplied by Yamaha are designed for seating only. No other uses are recommended.

## PLEASE KEEP THIS MANUAL

Thank you for purchasing the Yamaha F-400 Electone Classic. The F-400 is a full-scale model electronic organ that combines Yamaha's very latest technology with its accumulated experience of many decades in making fine musical instruments.

The F-400 features a wealth of realistic and natural pipe organ sounds created with new AWM (Advanced Wave Memory) sound sources.

Please read this manual carefully in order to get the most out of your new Electone Classic Organ.

**Included Items :**

Classic Organ F-400,

Pedal (BDO),

Bench,

Custom Tone Card (2),

Pedal Keyboard connecting cable,

Keyboard Amplifier KA-75 (2),

XLR cables (4),

Owner's Manual

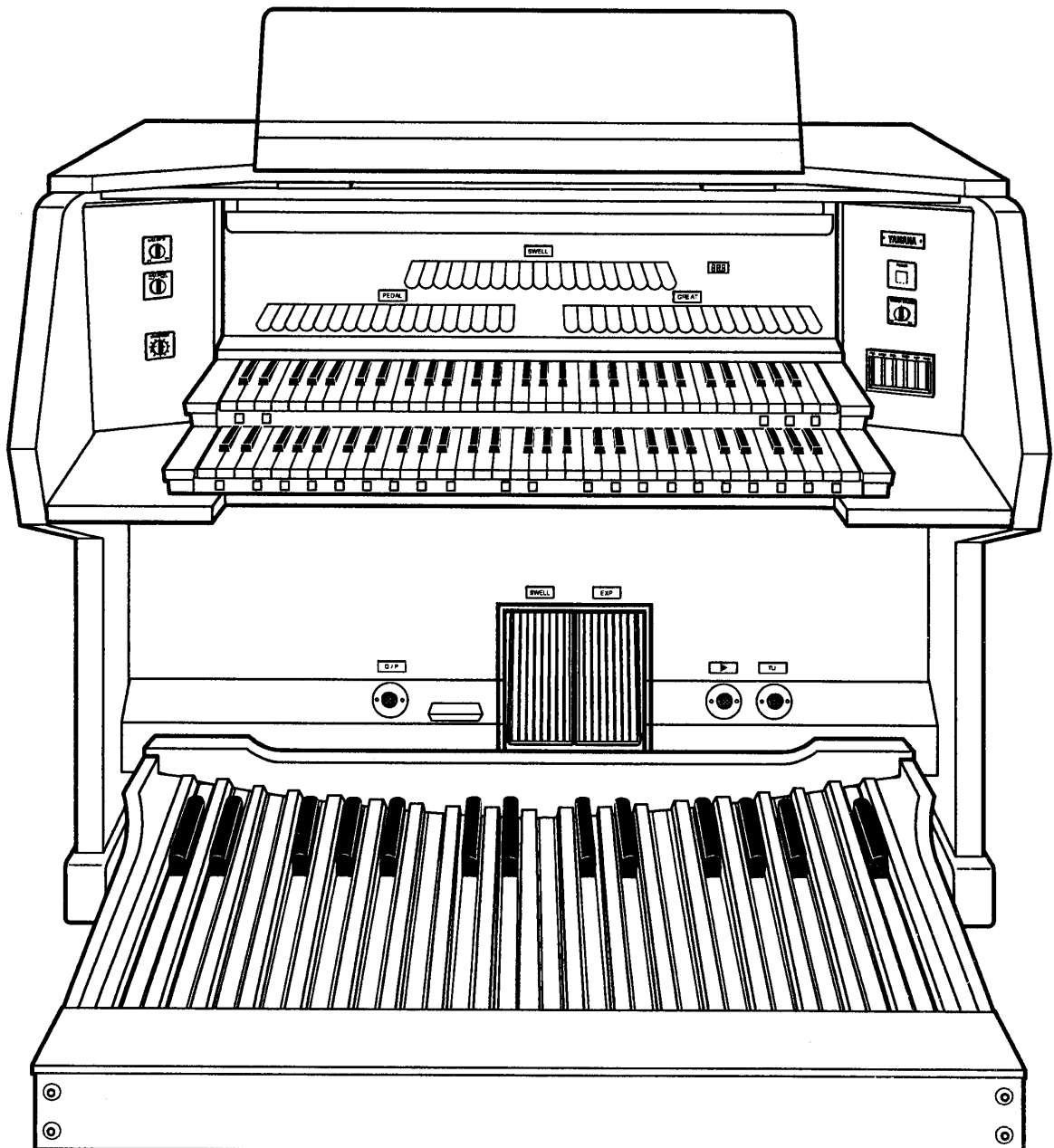

## Installing the Pedal Keyboard

The Pedal keyboard can easily be installed and removed. When installing or removing the unit, make sure to use two people, and firmly grasp both sides to avoid damage to the keyboard.

1. Connect the Pedal keyboard to the F-400 by using the included Pedal keyboard connecting cable.

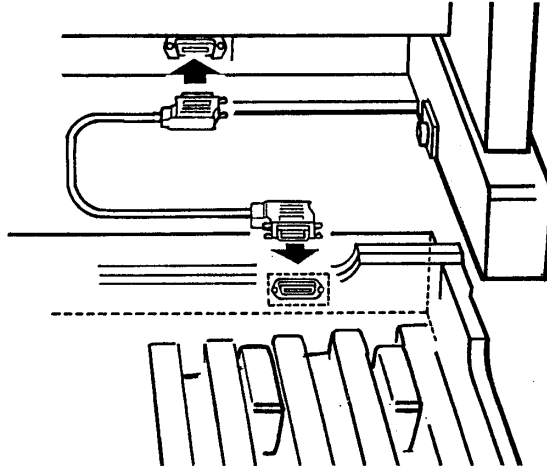

2. After inserting the connecting cable firmly into the connectors on both ends, lock the cable in place with the lock springs on each connector end.

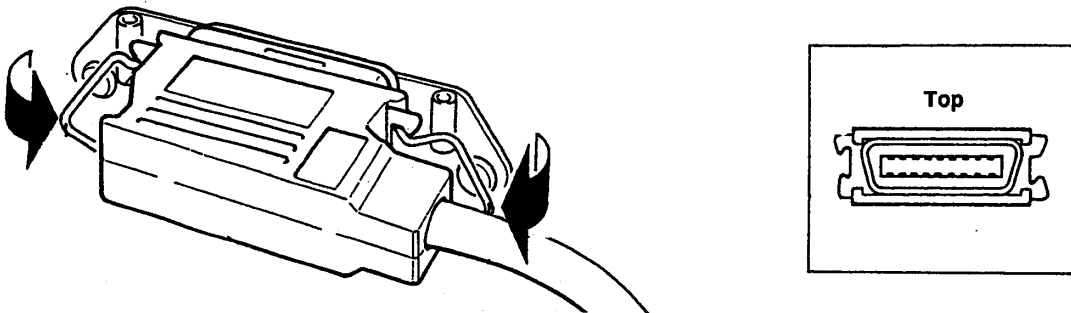

3. Move the Pedal keyboard into place with two people, each holding up one side of the unit and moving it into place.

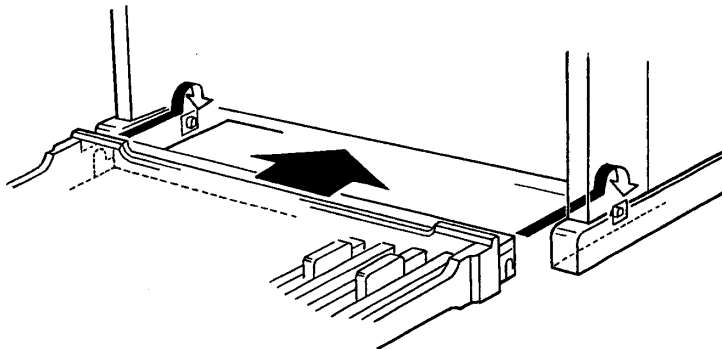

To remove the Pedal keyboard: Pull the unit up partially, then pull it out towards you.

## Transporting the F-400

Keep in mind the following points when moving the F-400:

- \* Make sure to remove the Pedal keyboard before moving.
- \* Unplug the power cord from the outlet, and unplug all cords connected to other devices, making sure that these cords are not tangled under the F-400.
- \* Pull out the transport handles on the rear of the instrument at both sides and use them to move the F-400.
- \* Bottom casters are provided for ease in moving the instrument. Casters move only from side to side, not forward and backward.

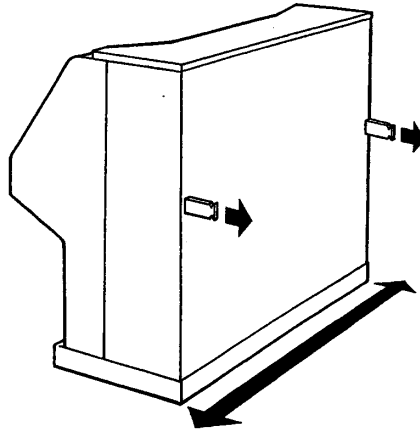

## Connecting a Keyboard Amplifier

Since the F-400 does not have a built-in speaker system, in order to hear the sounds of the instrument other than through headphones, you will have to connect a keyboard amplifier (power amplifier/speaker system). Use an amplifier/speaker system such as the Yamaha KA-75 Keyboard Amplifier.

## Rear Panel Output Terminals

Output terminals for connection to a keyboard amplifier are located on the rear of the instrument at the bottom.

### ① REMOTE (5-pin DIN connector)

This is used as a remote power switch for the connected keyboard amplifiers, allowing you to turn them on and off from the power switch of the F-400. A conventional MIDI cable can be used.

### ② MAIN LEFT/RIGHT (XLR)

The main channel stereo signals are output through these terminals.

### ③ REAR LEFT/RIGHT (XLR)

The rear channel stereo signals are output through these terminals.

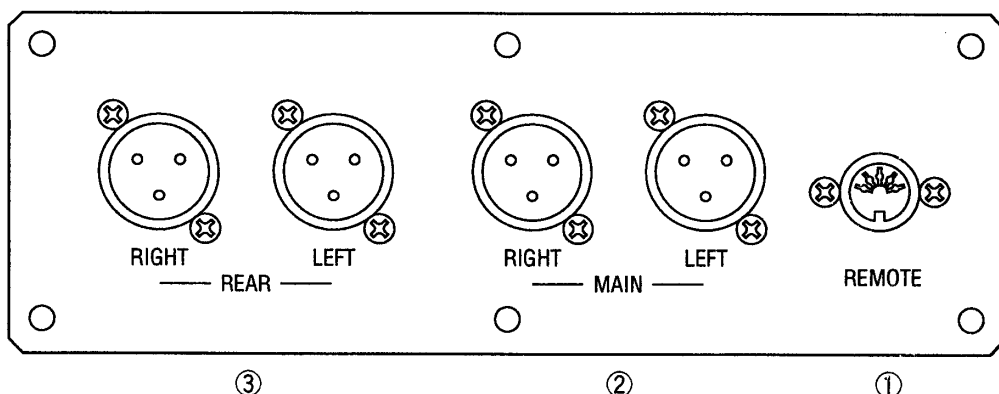

### Example Connection -- Keyboard Amplifier

The recommended Yamaha KA-75 Keyboard Amplifier is used in this connection example.

When connecting two keyboard amplifiers:

Connect two XLR cables as shown in Fig. 1.

When using the F-400 to turn the connected keyboard amplifiers on and off, connect them by MIDI cable as indicated by the dotted line in Fig. 1.

Fig. 1

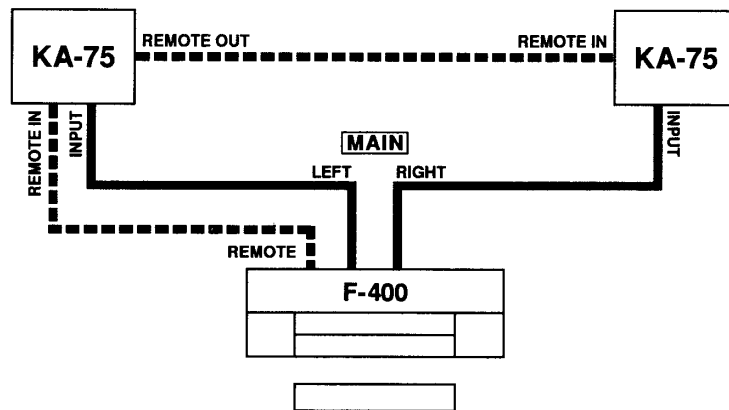

When connecting four keyboard amplifiers:

Connect them as shown in Fig. 2 by using XLR cables. Install the rear keyboard amplifiers as high off the ground as possible.

When using the F-400 power switch to turn the connected keyboard amplifiers on and off, connect the units by MIDI cable as indicated by the dotted line in Fig. 2.

Fig. 2

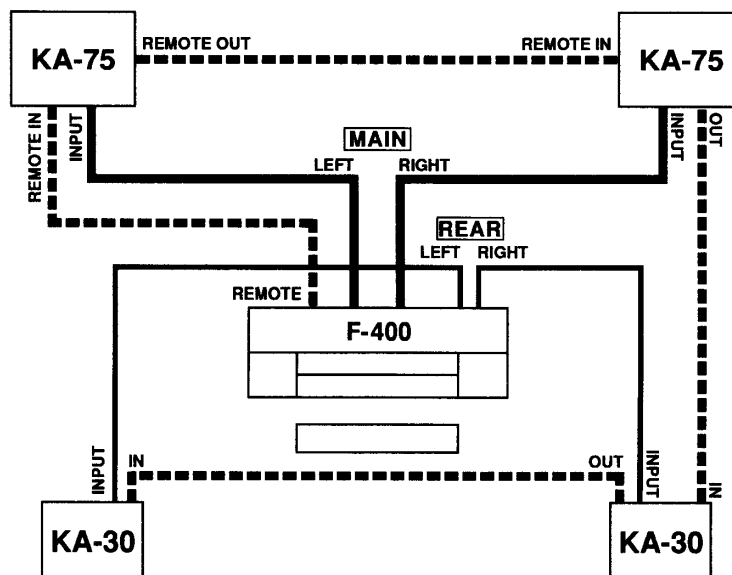

# 1 Before Playing the F-400

1. Insert the plug into a proper AC outlet.
2. Turn on the F-400 by pressing the POWER switch.

The foot light underneath the keyboard lights up when the power switch is turned on.

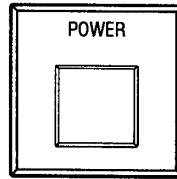

In order to light the panel: Turn on the LIGHT switch at the bottom part of the keyboard.

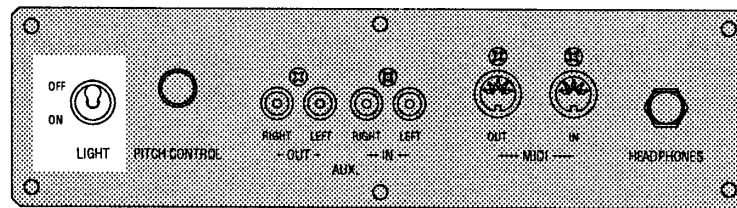

3. Set the MASTER VOLUME to an appropriate level.

The master volume controls the entire sound level of the instrument.

4. Adjust the entire sound level as you play by using the Expression pedal.

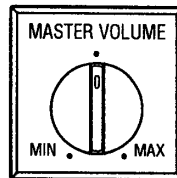

The Swell pedal, which is found at the left of the Expression pedal, controls only the volume of the Swell keyboard.

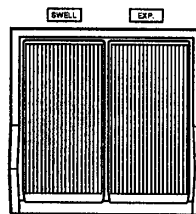

About the Pedal Position Display:

The depth of the Expression pedal and the Swell pedal (or how far each pedal has been pressed down) is indicated in the display at the right side of the panel. Range: 0 ~ 9

Pedal Depth

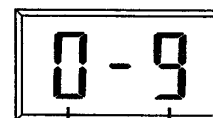
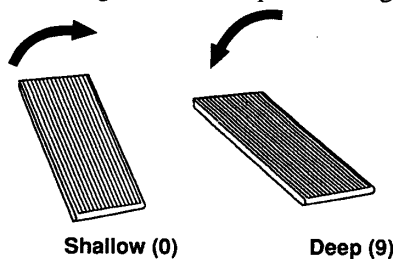

Swell Pedal (left)

Expression Pedal (right)



## 2. Organ Voice Stops

There are a total of 38 voice stops for each keyboard, Swell, Great, and Pedal. There are several different footage settings [indicated by a number and apostrophe (')] in the voices. The voice stops of each keyboard can be freely combined for playing.

Tabs on the panel are used to turn voice stops on and off, allowing voices to be changed easily and quickly even during a performance.

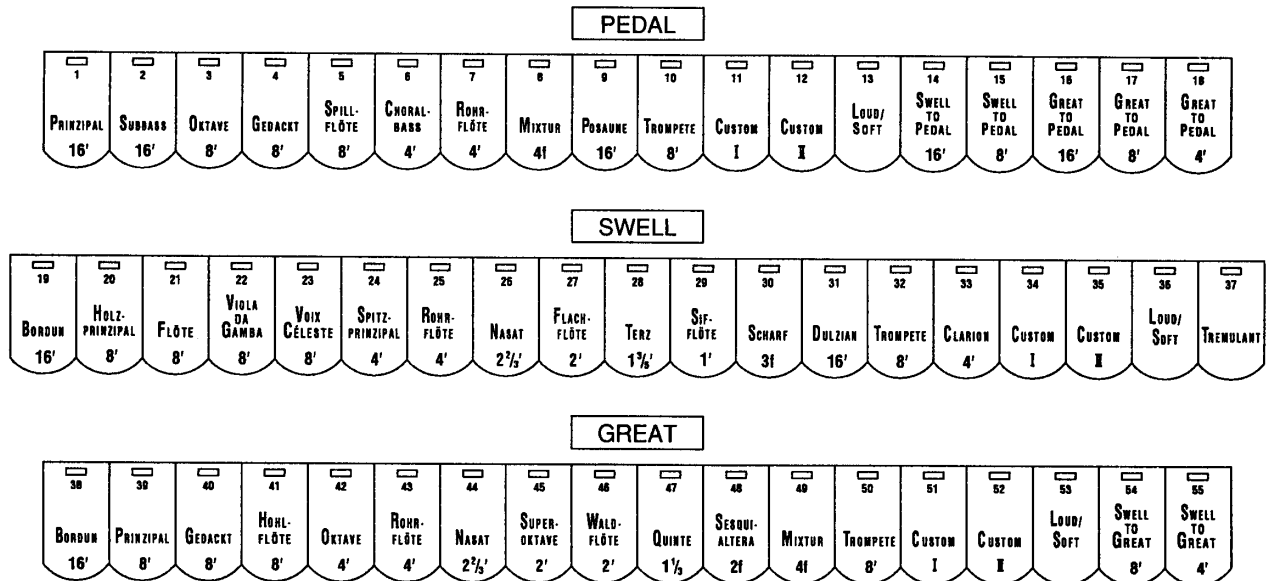

### Operation of the Voice Stops

To turn on a stop, press the tab down. The lamp of the stop lights up when it is turned on.

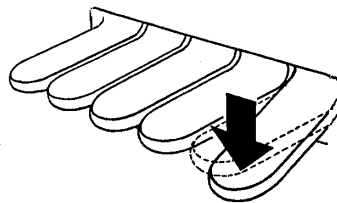

To turn the stop off, lift the tab up (or, alternately, press the tab down once again). The lamp of the stop goes out, and the stop is turned off.

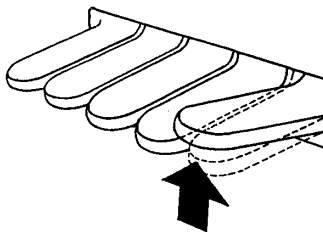

The F-400 has a variety of internal voices such as the clear Flue pipe group, including the Prinzipal group which consists of the basic organ sounds, the Reed pipe group which has a rich and warm sound, and the bright Mixtur group. Besides these built-in voices, other voices can be added by using the optional Custom Tone Cards.

**Note:** The combinations of the voices, including the effect settings, can be memorized to a combination button. The memorized combinations can then be called up by the press of a single button while you play.  
(See page 10.)

**Note:** All voice stops currently on can be cancelled (turned off) by pressing the C (Cancel) button.  
(See page 12.)

### Custom Tone – Additional Voices

In addition to the installed voices, the F-400 includes special Custom stops (I and II) for each keyboard. Two voices can be added by using Custom Tone cards. (Two cards are included with the instrument; optional cards are also available.)

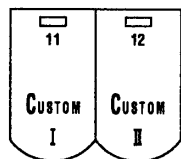

PEDAL

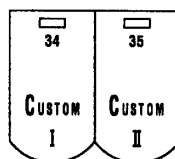

SWELL

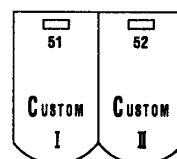

GREAT

#### To use the Custom I and II stops:

1. With the power off, insert the Custom Tone Card into the card slot of the keyboard.

(For example, in order to use a voice with the Custom II stop of the Swell keyboard, insert the Custom Tone Card into the SWELL CUSTOM II card slot.)

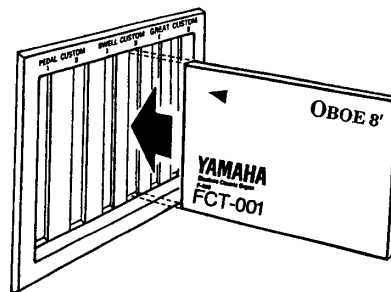

**Note:** Custom Tone Cards can be used in any slot (any keyboard).

2. Turn on the Custom stop.

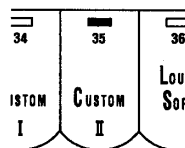

- \* Make sure to turn the power off on the F-400 before inserting or pulling out the Custom Tone Card.
- \* Be careful to insert the Card properly, with the label facing the keyboards. (See illustration above.)

**Note:** The Custom stop does not function if a Custom Tone Card has not been inserted.

### 3. Effects

The effect tab (brown) can be found at the right of the voice stops. The effect tab is used to modify the voice for each keyboard. All keyboards have a Loud/Soft control, and the Swell keyboard has a Tremulant.

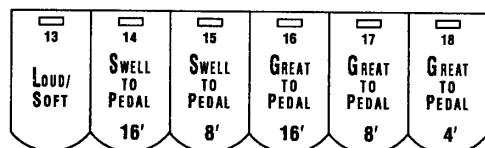

PEDAL

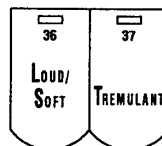

SWELL

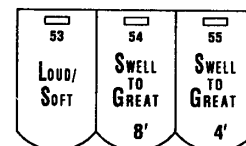

GREAT

#### 1. Loud/Soft

This control allows you to change the volume of a keyboard, making it louder or softer relative to the other keyboards.

To make one keyboard louder than the others: Lift up the LOUD/SOFT tab.

– The tab lamp lights up in red to indicate it is set to LOUD.

To make one keyboard softer than the others: Press the LOUD/SOFT tab down.

– The tab lamp lights up in green to indicate it is set to SOFT.

This tab has three settings: relatively loud (red), standard (light is off), and relatively soft (green).

#### 2. Tremulant

Turning the Tremulant on adds a vibrato effect (periodic varying of the volume) to the voices.

#### 3. Coupler

This control allows you to instantly assign the voices that have been set for one keyboard to another keyboard. Since this makes it possible to simultaneously play the sounds of two keyboards by playing just one of them (coupler function), it provides a richer sound and makes available a wider variety of sound combinations.

##### Swell To Pedal 16'/8'

When the SWELL TO PEDAL Coupler is on, the Swell voice is combined with the Pedal voice for playing from the Pedal keyboard.

SWELL TO PEDAL 16'= Adds the sound one octave lower than normal.

SWELL TO PEDAL 8'= Adds the sound at the same octave.

##### Great To Pedal 16'/8'/4'

When the GREAT TO PEDAL Coupler is on, the Great voice is combined with the Pedal voice for playing from the Pedal keyboard.

GREAT TO PEDAL 16'= Adds the sound one octave lower than normal.

GREAT TO PEDAL 8'= Adds the sound at the same octave.

GREAT TO PEDAL 4'= Adds the sound one octave higher than normal.

### G/P (Great To Pedal) Toe Piston

By pressing the Toe Piston, located at the left of the Swell Pedal, the voices of the Great keyboard can also be played from the Pedal keyboard (just as with the coupler function of GREAT TO PEDAL 8').

This allows you to turn on the coupler function with your foot as you play, without having to take your hand from the keyboard. In this case, the coupler tab (GREAT TO PEDAL 8') and the Toe Piston function in the same way. It can be turned off by pressing the Toe Piston while the coupler tab of GREAT TO PEDAL 8' is on.

G/P

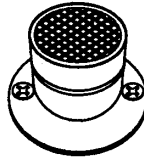

### Swell To Great 8'/4'

When the SWELL TO GREAT Coupler is on, the Swell voice is combined with the Great voice for playing from the Great keyboard.

SWELL TO GREAT 8' = Adds the sound at the same octave.

SWELL TO GREAT 4' = Adds the sound one octave higher than normal.

**Note:** When the coupler function is used, all effects such as Loud/Soft and Tremulant applied to the first (source) keyboard will still be active when played from the second (destination) keyboard.

## 4. Hall Effect (Reverb)

This effect adds a reverberant ambience to the sound and gives it more depth and dimension. In addition to being able to set the depth of the reverb effect, you can also select the type of room simulation.

### Hall Depth

The Hall effect is most pronounced at MAX and least pronounced at MIN.

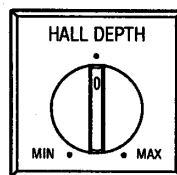

### Hall Type

This allows you to select the type of hall or environment simulated by the Hall effect. Select the type according to the actual size of the room in which the F-400 is located as well as the type of song being performed.

HALL 1: Mid-size hall

HALL 2: Large hall

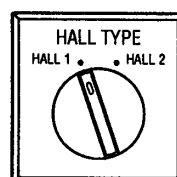

## 5. Combinations

### 1. Combinations (Registration Memory)

The F-400 lets you instantly change all panel settings by using the Combination controls. Simply set the registrations you want beforehand, such as the voice stops or effects for each keyboard, and then call them up during a performance by using the convenient Combination buttons.

There are 80 available Combination memory locations: ten numbers each in eight different banks (or groups), A through H.

### Storing a Registration

1. Set the registration to be memorized.

**Note:** When the power is turned on, only group button A will be lit. All number buttons will be off.

2. Decide the Combination number to which the registration are to be stored.

In this example, the settings are stored to B-1 (number 1 of group B).

3. Select the group first. Press the B button.

The B button starts flashing. The registration is not stored at this point yet.

4. Simultaneously hold down the S.(SET) button, found underneath the bottom left corner of the Great keyboard, and press the number of the desired button (number 1, in this example).

5. The Combination number button flashes to indicate that the registration has been stored.

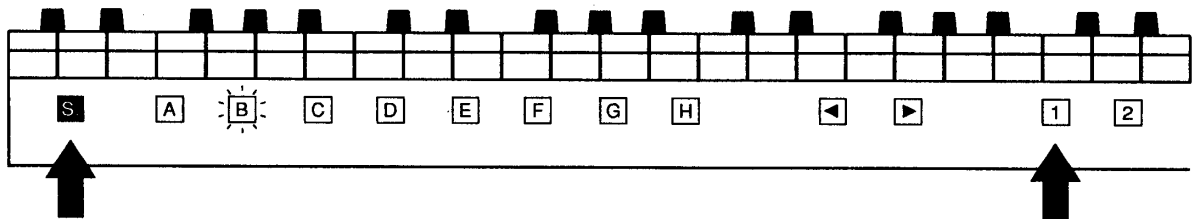

**Note:** The previously selected number will automatically be restored if a number button is not pressed within 20 seconds after a group button has been pressed and starts flashing.

### Calling Up a Registration

To call up a registration, simply press the appropriate buttons for the desired Combination (for example, B and 1). The settings of the selected Combination button are then set for the keyboard.

## About Combination Shift

The Combination Shift function allows you to continuously call up stored registrations in their numerical and alphabetical order, with the press of a single button.

Combination Shift is used with two buttons:

The ◀ button selects the next Combination button.

The ▶ button selects the previous Combination button.

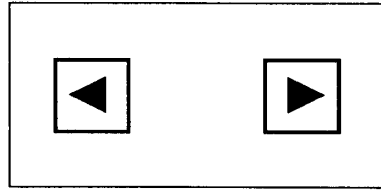

For maximum performance convenience, the Combination Shift function can be controlled from three different locations:

1. At the center underside of the Great keyboard (◀, ▶).
2. At the left corner between the Swell and Great keyboards (◀, ▶). These are intended for the use of an assistant to the performer.
3. From the Toe Piston (▶ only), which is at the right of the Expression pedal. Pressing the Toe Piston selects the next combination.

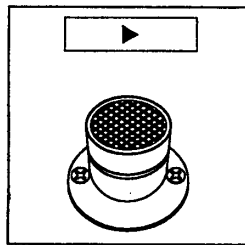

**Note:** Pressing the ▶ button moves between successive groups when at the last number of a group. (For example, pressing the ▶ button from A-10 selects B-1.)

**Note:** The stored Combinations are backed up in memory with a built-in lithium battery. The battery life is approximately 7 years. When necessary, have an authorized Yamaha dealer change the battery.

## 2. Tutti (TU.)

All voice stops of all keyboards, with the exception of several voice stops like Custom Tone, can be turned on by pressing the TU. (Tutti) button located at the right underside of the Swell keyboard. The TU. lamp lights up.

In this case, all voice stop lamps which are set to Tutti, are lit up.

Pressing the TU. button again cancels the Tutti function and restores the previous settings.



### Tutti Toe Piston

The Tutti function can also be turned on by pressing the Toe Piston at the right of the Expression pedal, instead of the Tutti button.

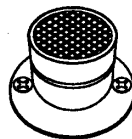
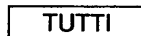

This allows you to turn on the Tutti function with your foot as you play, without having to take your hand from the keyboard. In this case, the Tutti and the Toe Piston function in the same way. Pressing the Toe Piston while the Tutti button is on turns Tutti off.

**Note:** Pressing any tab stop when Tutti (and the TU. lamp) is on automatically cancels the Tutti function, and the light of the Tutti button goes out.

### 3. Reed Off (R.O.)

Pressing the R.O. (REED OFF) button to the left of the Tutti button selectively turns off only the voices of the Reed group. The R.O. lamp lights.



Pressing the button again cancels the Reed Off function and returns to the previous setting.

**Note:** Pressing the Reed Off button while Tutti is on, causes the Tutti function to sound without the voices of the Reed group.

**Note:** Pressing a tab stop of the Reed group when Reed Off is on automatically cancels the Reed Off function, and the light of the Reed Off button goes out.

### 4. Cancel (C.)

Pressing the C. (CANCEL) button to the right of the Tutti button turns off all voice stops. This function is convenient when making panel settings from scratch.



## 6. Other Functions

### 1. Transposer

The TRANSPOSER control on the left side of the panel allows you to transpose the pitch of the instrument in semitone units. Range: -6 ~ +5

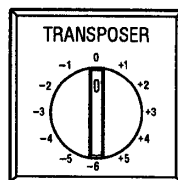

### 2. Pitch Control

The PITCH CONTROL dial ① underneath the keyboard allows you to finely adjust the pitch of the instrument. The center position is the standard frequency of 440 Hz for key A3. Range: 432 Hz ~ 448 Hz

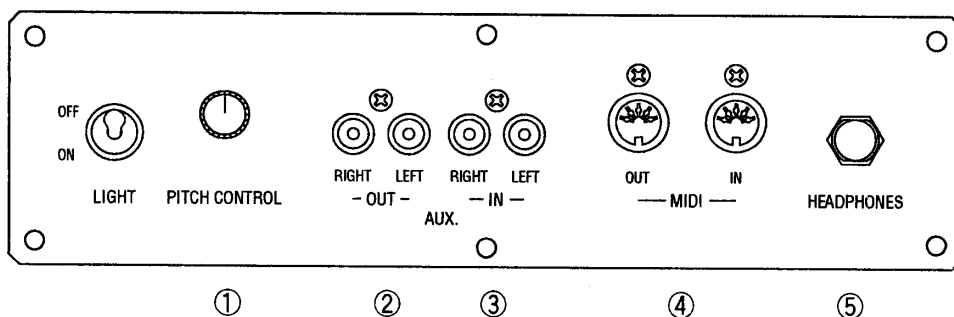

### **3. Other Jacks and Terminals (located under the keyboard)**

#### **② AUX. OUT L/R (RCA)**

The stereo audio signal of the F-400 is output to connected external devices. When connecting the F-400 to keyboard amplifiers, use the XLR outputs located at the bottom of the rear panel of the instrument. (See page 3.)

#### **③ AUX. IN L/R (RCA)**

These jacks are for input of an external stereo sound source. The external sound can be output together with the sound of the F-400 through the connected keyboard amplifier.

#### **④ MIDI IN/OUT**

These terminals are used for controlling and transferring data with another MIDI (Musical Instrument Digital Interface) compatible device.

Using MIDI and the optional MDR-3 Music Disk Recorder, you can record and play back a performance on the F-400. (See below.) The two units must be connected by a special MIDI cable.

#### **⑤ HEADPHONES**

This jack is for connection of a stereo headphone set. When a set of headphones is connected and the REMOTE function (page 3.) is used to control the connected keyboard amplifiers, sound to these units is automatically cut off, allowing you to play without disturbing others. We recommend that you use the same kind of headphones that are recommended for use with Electones.

## **About MIDI**

The F-400 is equipped with MIDI IN/OUT terminals. MIDI and the wide variety of MIDI-compatible musical instruments and other devices vastly extend the music-making potential of the F-400.

One MIDI application involves the use of the MDR-3 Yamaha Music Disk Recorder, which lets you record and play back your performances on the F-400. Specifically, you can record a performance on the F-400 and store that data to a floppy disk, and play back the performance anytime you want by using that data.

### **Main MIDI Data Transmitted and Received**

#### **Key ON/OFF Data (note on/off)**

Swell keyboard: Transmitted/received over channel 1

Great keyboard: Transmitted/received over channel 2

Pedal keyboard: Transmitted/received over channel 3

#### **Stop ON/OFF Data (program change)**

Swell keyboard stops: Transmitted/received over channel 1

Great keyboard stops: Transmitted/received over channel 2

Pedal keyboard stops: Transmitted/received over channel 3

#### **Data of Panel Button Changes (program change)**

Changing Combinations: Transmitted/received over channel 16

TUTTI on/off: Transmitted/received over channel 16

REED on/off: Transmitted/received over channel 16



Pedal Data (control change)

Expression pedal data: Transmitted/received over channel 16

Swell pedal data: Transmitted/received over channel 16

Bulk Data (exclusive messages)

Panel settings: Transmitted/received regardless of set channel

Stored registration settings: Transmitted/received regardless of set channel

The F-400 can be set to receive performance data from the connected MIDI recorder without receiving the stored registration data.

To set the F-400 to receive only performance data:

1. Turn off the power.
2. Simultaneously hold down the Combination S button and turn the power back on.

**Note:** To restore the F-400 to normal operation (reception of all data), simply turn the power on again.

## Use of the MDR-3 Music Disk Recorder

Connect the F-400 and MDR-3 by using two MIDI cables. Refer to the owner's manual of the MDR-3 for details.

### MDR-3 Functions and Applications

The MDR-3 allows you to:

Record a performance

Play back a performance

Separately record selected parts of a performance

Separately play back selected parts of a performance

Repeatedly play back a song or songs

Change the playback tempo

Copy/delete a song

Record panel settings (bulk data)

Call up panel settings (bulk data)

# F-400 MIDI Implementation Chart

Date: 31 July '92  
Version: 1.0

Function		Transmitted	Recognized	Remarks
Basic Channel	Default Changed	1, 2, 3, 16 ×	1, 2, 3, 16 ×	*1
Mode	Default Messages Altered	Mode 3 × *****	Mode 3 × ×	
Note Number	True Voice	36-96, 36-67 *****	36-96, 36-67 36-96, 36-67	*2 *2
Velocity	Note ON Note OFF	○ 9nH, v=1-127 ○ 8nH, v=1-127	○ 9nH, v=1-127 ○ 8nH, v=1-127, 9nH, v=0	
After Touch	Key's Ch's	× ×	× ×	
Pitch Bend		×	×	
Control Change	11 16 81	○ ○ ○ *3	○ ○ ○ *3	Expression pedal Swell pedal Cancel
Program Change	True #	0-36, 38-39 *3 0-32, 34-37 *3 0-32, 34-37 *3 32-39, 48-57 *3 *****	0-36, 38-39 *3 0-32, 34-37 *3 0-32, 34-37 *3 32-39, 48-57 *3	Swell Great Pedal Combination
System Exclusive		○ *4	○ *5	
Common	Song Position Song Select Tune	× × ×	× × ×	
System Real Time	Clock Commands	× ×	× ×	
Aux Messages	Local ON/OFF All Notes OFF Active Sense Reset	× × ○ ×	× ○ *6 ○ ×	
Notes		*1 = CH1: Swell, CH2: Great, CH3: Pedal, CH16: Control *2 = 36-96 (Swell, Great), 36-67 (Pedal) *3 = Power on mode *4 = Bulk data *5 = Bulk data transmit request, bulk data *6 = Receive on basic and control channels		

Mode 1: OMNI ON, POLY  
Mode 3: OMNI OFF, POLY

Mode 2: OMNI ON, MONO  
Mode 4: OMNI OFF, MONO

○: YES  
×: NO

## Troubleshooting

The problems listed below are not malfunctions of the F-400 itself, but arise from unfamiliarity with the instrument or external causes.

We suggest that you read the following section carefully to understand possible problems while using the F-400 and more completely familiarize yourself with the instrument.

### ● Problem

Possible Cause and Solution

### ● A crackling static-like noise is sometimes heard.

Noise may be produced when either an electrical appliance is turned on or off, or an electric power tool (such as a drill) is used in the proximity of the F-400. If this occurs, plug the F-400 into an electrical outlet located as far as possible from the device that seems to be the source of the problem.

### ● Interference from radio, TV, or other sources occurs.

This is caused by the proximity of a high-power broadcasting station or amateur ham radio setup. If the interference is too much to be tolerated, consult the store at which you purchased the F-400 or your local musical instrument dealer.

### ● Noise or other interference is received on a radio or TV set.

If a radio or TV set are placed to close to the F-400, they may receive some noise or interference. Use the F-400 as far from the affected devices as possible.

### ● The sound of the F-400 causes surrounding objects to resonate.

Because the F-400 produces a continuous and potentially loud sound, resonance may be caused in surrounding objects, such as cabinets or glass windows. To avoid this, relocate the objects or lower the volume of the F-400.

### ● Sound cannot be heard through the speakers.

- (1) Check all cord connections to the keyboard amplifiers.
- (2) Check that the connected keyboard amplifiers are turned on.

### ● Sound is too soft.

- (1) Check the position of the Master Volume and the Expression Pedal.
- (2) Check the volume of the connected keyboard amplifiers.

### ● The sound of the F-400 is different than what the currently set panel settings would indicate.

The coupler stop is ON for the Pedal or Great keyboards. When the coupler stop is set to ON, the stops set for the other keyboard (source for the coupler) is also output.

### ● Sound is not output even though the Custom stop is turned on.

- (1) The Custom stop can sound only when a Custom card has been inserted into the card slot. Turn off the power before inserting the Custom Tone card.
- (2) Insert the card properly. Make sure that the front side of the card faces the keyboards.

# F-400 Electone Classic Organ Specifications

## Keyboards

Great: 61 keys C1 - C6 Maximum polyphony: 16

Swell: 61 keys C1 - C6 Maximum polyphony: 16

Pedal: 32 keys C1 - G3 Maximum polyphony: 4 (BDO)

## Stops

**Great:** Stops 13 (Bordun 16', Prinzipal 8', Gedackt 8', Hohlflöte 8', Oktave 4', Rohrflöte 4', Nasat 2-<sup>2</sup>/<sub>3</sub>', Superoktave 2', Waldflöte 2', Quinte 1-<sup>1</sup>/<sub>3</sub>', Sesquialtera 2f, Mixtur 4f, Trompete 8')

Custom Stops 2 (Custom 1, Custom 2) Included standard voice card: Krummhorn 8'

Effect: Loud/Soft

**Swell:** Stops 15 (Bordun 16', Holzprinzipal 8', Flöte 8', Viola da Gamba 8', Voix Céleste 8', Spitzprinzipal 4', Rohrflöte 4', Nasat 2-<sup>2</sup>/<sub>3</sub>', Flachflöte 2', Terz 1-<sup>3</sup>/<sub>5</sub>', Sifflöte 1', Scharf 3f, Dulzian 16', Trompete 8', Clarion 4')

Custom Stops 2 (Custom 1, Custom 2) Included standard voice card: Oboe 8'

Effects: Loud/Soft, Tremulant

**Pedal:** Stops 10 (Prinzipal 16', Subbass 16', Oktave 8', Gedackt 8', Spillflöte 8', Choralbass 4', Rohrflöte 4', Mixtur 4f, Posaune 16', Trompete 8')

Custom Stops 2 (Custom 1, Custom 2)

Effect: Loud/Soft

## Coupler

Great: Swell to Great 8', Swell to Great 4'

Pedal: Swell to Pedal 16', Swell to Pedal 8'

Great to Pedal 16', Great to Pedal 8', Great to Pedal 4', Great to Pedal Piston

## Combinations

General 8×10, Combination Shift (◀, ▶), Combination Shift Piston, Tutti, Tutti Piston, Reed Off, Cancel

## Other Controls

Expression Pedal, Swell Pedal, Master Volume, Hall Depth / Type, Transposer, Pitch Control

## Input/Output Terminals

Main Out (L/R; XLR), Rear Out (L/R; XLR), Headphones Out, AUX In/Out (L/R; RCA), MIDI In/Out

## Indicators

Panel Light (with switch), Pedal Light, Pedal Position Number Display

## Cabinet/Finish

White oak, with polyethylene paint

## Power Requirements/Consumption

Rated Voltage: 230 V

Rated Power Consumption: 80 W

**Dimensions**

Main Unit (W × D × H): 148 × 114.5 (with pedal) × 128 cm (58-1/4" × 45" × 50 -<sup>3</sup>/<sub>8</sub> ")

Bench (W × D × H): 142 × 35.5 × 63.5 cm (55 -<sup>7</sup>/<sub>8</sub> " × 14" × 25")

**Weight**

Main Unit: 156 kg (343 lbs., 15 oz.)

Pedal Keyboard: 47 kg (103 lbs., 10 oz.; BDO)

Bench: 22 kg (48 lbs., 8 oz.)

**Optional Equipments**

Custom Tone Cards, KA Series Keyboard Amplifiers, M.D.R.-3 Music Disk Recorder