

SILENT *Piano*TM

SC2

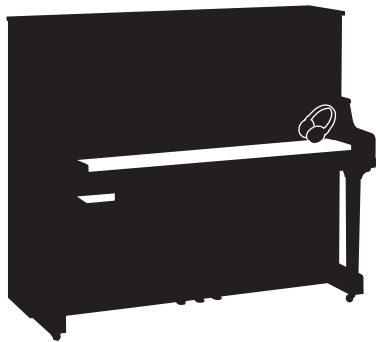

Owner's Manual
Mode d'emploi
Manual de instrucciones
Bedienungsanleitung
Manuale di istruzioni
사용설명서

Before using the instrument, be sure to read "PRECAUTIONS" on pages 7-8.

Avant d'utiliser cet instrument, lisez attentivement la section « PRÉCAUTIONS D'USAGE » aux pages 7-8.

Antes de utilizar el instrumento, lea la sección "PRECAUCIONES", en las páginas 7-8.

Achten Sie darauf, vor Einsatz dieses Instruments die „VORSICHTSMASSNAHMEN“ auf Seiten 7-8 durchzulesen.

Prima di utilizzare lo strumento, assicurarsi di leggere la sezione "PRECAUZIONI", alle pagine 7 - 8.

악기를 사용하기 전에 7 - 8페이지의 "안전 주의사항"을 꼭 읽으십시오.

SPECIAL MESSAGE SECTION

This product utilizes batteries or an external power supply (adapter). DO NOT connect this product to any power supply or adapter other than one described in the manual, on the name plate, or specifically recommended by Yamaha.

WARNING: Do not place this product in a position where anyone could walk on, trip over, or roll anything over power or connecting cords of any kind. The use of an extension cord is not recommended! If you must use an extension cord, the minimum wire size for a 25' cord (or less) is 18 AWG. NOTE: The smaller the AWG number, the larger the current handling capacity. For longer extension cords, consult a local electrician.

This product should be used only with the components supplied or; a cart, rack, or stand that is recommended by Yamaha. If a cart, etc., is used, please observe all safety markings and instructions that accompany the accessory product.

SPECIFICATIONS SUBJECT TO CHANGE:

The information contained in this manual is believed to be correct at the time of printing. However, Yamaha reserves the right to change or modify any of the specifications without notice or obligation to update existing units.

This product, either alone or in combination with an amplifier and headphones or speaker/s, may be capable of producing sound levels that could cause permanent hearing loss. DO NOT operate for long periods of time at a high volume level or at a level that is uncomfortable. If you experience any hearing loss or ringing in the ears, you should consult an audiologist.

IMPORTANT: The louder the sound, the shorter the time period before damage occurs.

Some Yamaha products may have benches and / or accessory mounting fixtures that are either supplied with the product or as optional accessories. Some of these items are designed to be dealer assembled or installed. Please make sure that benches are stable and any optional fixtures (where applicable) are well secured BEFORE using.

Benches supplied by Yamaha are designed for seating only. No other uses are recommended.

NOTICE:

Service charges incurred due to a lack of knowledge relating to how a function or effect works (when the unit is operating as designed) are not covered by the manufacturer's warranty, and are therefore the owners responsibility. Please study this manual carefully and consult your dealer before requesting service.

ENVIRONMENTAL ISSUES:

Yamaha strives to produce products that are both user safe and environmentally friendly. We sincerely believe that our products and the production methods used to produce them, meet these goals. In keeping with both the letter and the spirit of the law, we want you to be aware of the following:

Battery Notice:

This product MAY contain a small non-rechargeable battery which (if applicable) is soldered in place. The average life span of this type of battery is approximately five years. When replacement becomes necessary, contact a qualified service representative to perform the replacement.

This product may also use "household" type batteries. Some of these may be rechargeable. Make sure that the battery being charged is a rechargeable type and that the charger is intended for the battery being charged.

When installing batteries, never mix old batteries with new ones, and never mix different types of batteries. Batteries MUST be installed correctly. Mismatches or incorrect installation may result in overheating and battery case rupture.

Warning:

Do not attempt to disassemble, or incinerate any battery. Keep all batteries away from children. Dispose of used batteries promptly and as regulated by the laws in your area. Note: Check with any retailer of household type batteries in your area for battery disposal information.

Disposal Notice:

Should this product become damaged beyond repair, or for some reason its useful life is considered to be at an end, please observe all local, state, and federal regulations that relate to the disposal of products that contain lead, batteries, plastics, etc. If your dealer is unable to assist you, please contact Yamaha directly.

NAME PLATE LOCATION:

The name plate is located on the bottom of the product. The model number, power requirements, etc., are located on this plate. The serial number is located behind the control unit. You should record the model number, serial number, and the date of purchase in the spaces provided below and retain this manual as a permanent record of your purchase.

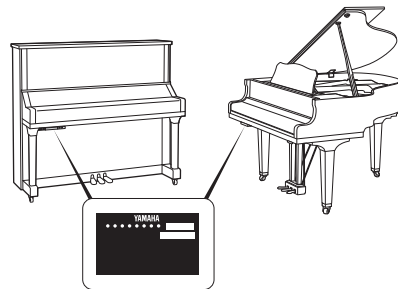

Model _____

Serial No. _____

Purchase Date _____

PLEASE KEEP THIS MANUAL

92-BP (bottom_silent)

For the instrument

COMPLIANCE INFORMATION STATEMENT (Supplier's declaration of conformity procedure)

Responsible Party: Yamaha Corporation of America
Address: 6600 Orangethorpe Ave., Buena Park, Calif. 90620
Telephone: 714-522-9011
Type of Equipment: Silent Piano
Model Name: B1SC2, B2SC2, B3SC2, GB1KSC2, P22SC2, RSC2-1, RSC2-3,
RSC2-5, RSC2-10, RSC2-30

This device complies with Part 15 of the FCC Rules.

Operation is subject to the following two conditions:

- 1) this device may not cause harmful interference, and
- 2) this device must accept any interference received including interference that may cause undesired operation.

* This applies only to products distributed by Yamaha Corporation of America.

(FCC SDoC)

For the AC adaptor and the instrument

FCC INFORMATION (U.S.A.)

1. IMPORTANT NOTICE: DO NOT MODIFY THIS UNIT!

This product, when installed as indicated in the instructions contained in this manual, meets FCC requirements. Modifications not expressly approved by Yamaha may void your authority, granted by the FCC, to use the product.

2. IMPORTANT: When connecting this product to accessories and/or another product use only high quality shielded cables. Cable/s supplied with this product MUST be used. Follow all installation instructions. Failure to follow instructions could void your FCC authorization to use this product in the USA.

3. NOTE: This product has been tested and found to comply with the requirements listed in FCC Regulations, Part 15 for Class "B" digital devices. Compliance with these requirements provides a reasonable level of assurance that your use of this product in a residential environment will not result in harmful interference with other electronic devices. This equipment generates/uses radio frequencies and, if not installed and used according to the instructions found in the users manual, may cause interference harmful to the operation of other electronic devices. Compliance with FCC regula-

tions does not guarantee that interference will not occur in all installations. If this product is found to be the source of interference, which can be determined by turning the unit "OFF" and "ON", please try to eliminate the problem by using one of the following measures:

Relocate either this product or the device that is being affected by the interference.

Utilize power outlets that are on different branch (circuit breaker or fuse) circuits or install AC line filter/s.

In the case of radio or TV interference, relocate/reorient the antenna. If the antenna lead-in is 300 ohm ribbon lead, change the lead-in to co-axial type cable.

If these corrective measures do not produce satisfactory results, please contact the local retailer authorized to distribute this type of product. If you can not locate the appropriate retailer, please contact Yamaha Corporation of America, Electronic Service Division, 6600 Orangethorpe Ave, Buena Park, CA90620

The above statements apply ONLY to those products distributed by Yamaha Corporation of America or its subsidiaries.

* This applies only to products distributed by YAMAHA CORPORATION OF AMERICA.

(class B)

The model number, power requirements, etc., are located on the name plate, which is at the bottom of the control unit. The serial number is located behind the control unit. You should note this serial number in the space provided below and retain this manual as a permanent record of your purchase to aid identification in the event of theft.

Model No.

Serial No.

(bottom_en_silent)

Modellnummer, Leistungsbedarf usw. sind auf dem Namensschild aufgeführt, das sich an der Unterseite der Steuereinheit befindet. Die Seriennummer befindet sich an der Rückseite der Steuereinheit. Für den Fall eines Diebstahls sollten Sie diese Seriennummer im unten vorgesehenen Feld eintragen und diese Anleitung als dauerhaften Kaufnachweis aufbewahren.

Modell Nr.

Seriennr.

(bottom_de_silent)

Le numéro de modèle de l'appareil, ses besoins en alimentation ainsi que d'autres informations le concernant figurent sur sa plaque signalétique, qui se trouve en bas de l'unité de commande. Le numéro de série est indiqué à l'arrière de l'unité de commande. Notez ce numéro de série dans l'espace fourni ci-dessous et conservez le présent manuel comme preuve permanente de votre achat afin de faciliter l'identification du produit en cas de vol.

N° de modèle

N° de série

(bottom_fr_silent)

Il numero del modello, i requisiti di alimentazione, ecc... si trovano sulla piastrina posizionata nella parte inferiore dell'unità di controllo. Il numero di serie si trova dietro l'unità di controllo. Si consiglia di riportare il numero di serie nell'apposito spazio di seguito e di conservare questo manuale come prova di acquisto permanente, al fine di consentire l'identificazione in caso di furto.

Numero del modello

Numero di serie

(bottom_it_silent)

El número de modelo, los requisitos de alimentación, etc. se encuentran en la placa de denominación, que está en la parte inferior de la unidad de control. El número de serie se encuentra detrás de la unidad de control. Debe anotar este número de serie en el espacio que se proporciona a continuación y conservar este manual como un registro permanente de su compra para facilitar la identificación en caso de robo.

N° de modelo

N° de serie

(bottom_es_silent)

본 제품의 모델 번호, 전원 규격 등은 기기 밑면에 있는 명판에서 확인할 수 있습니다. 일련 번호는 기기 후면에 있습니다. 도난 시 확인할 수 있도록 일련 번호를 아래 공란에 기입하고 본 사용설명서를 구매 기록으로 영구 보관해야 합니다.

모델 번호

일련 번호

(bottom_ko_silent)

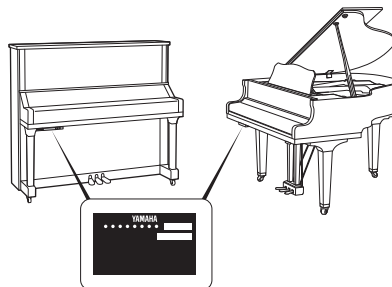

The name plate is located on the bottom of the unit.
La plaque signalétique de ce produit se trouve dans le bas de l'unité.
La placa del nombre se encuentra en la parte inferior de la unidad.
Das Namensschild befindet sich an der Unterseite des Produkts.
La targhetta del nome si trova sul fondo dell'unità.
명판은 제품 밑면에 부착되어 있습니다.



SILENT *Piano*TM

SC2

Owner's Manual

Table of Contents

PRECAUTIONS.....	7	Chapter 4 Connecting to Other Devices	30
NOTICE	9	
About the Manuals	10	Connecting to external audio devices ([AUX IN] jack).....	30
Included Accessories	10	Connecting to a computer/smart device	31
Features.....	11	Chapter 5 Using Other Functions	33
Chapter 1 Getting Started	12	Setting the various convenient functions	33
Part names.....	12	Backup data and initialization.....	40
Turning the power on/off	14	Chapter 6 Appendix	41
Using headphones.....	15	Troubleshooting.....	41
Chapter 2 Playing with the Silent PianoTM Function.....	16	Specifications	42
Using the Silent Piano TM function	16	Song List.....	43
Selecting Voices.....	17	Quick Operation Guide.....	44
Using the metronome.....	19	Index	45
Chapter 3 Recording and Playback.....	22		
Recording your performance to internal memory (MIDI recording).....	22		
Playing back the MIDI Song recorded to internal memory	23		
Recording your performance to a USB flash drive (Audio recording)	24		
Playing back an Audio Song recorded to the USB flash drive	24		
Connecting USB devices	25		
Playing back the Voice Demo Songs	26		
Playing back the Preset Songs	27		
Operations during playback	28		
Adjusting the playback tempo.....	29		

Information for users on collection and disposal of old equipment:



This symbol on the products, packaging, and/or accompanying documents means that used electrical and electronic products should not be mixed with general household waste. For proper treatment, recovery and recycling of old products, please take them to applicable collection points, in accordance with your national legislation. By disposing of these products correctly, you will help to save valuable resources and prevent any potential negative effects on human health and the environment which could otherwise arise from inappropriate waste handling.

For more information about collection and recycling of old products, please contact your local municipality, your waste disposal service or the point of sale where you purchased the items.

For business users in the European Union:

If you wish to discard electrical and electronic equipment, please contact your dealer or supplier for further information.

Information on Disposal in other Countries outside the European Union:

This symbol is only valid in the European Union. If you wish to discard these items, please contact your local authorities or dealer and ask for the correct method of disposal.

(weee_eu_en_02)

For the AC adaptor

This device complies with Part 15 of the FCC Rules. Operation is subject to the following two conditions: (1) this device may not cause harmful interference, and (2) this device must accept any interference received, including interference that may cause undesired operation.

(fcc_sengen-c)

CAN ICES-3 (B)/NMB-3(B)

(can_b_02)

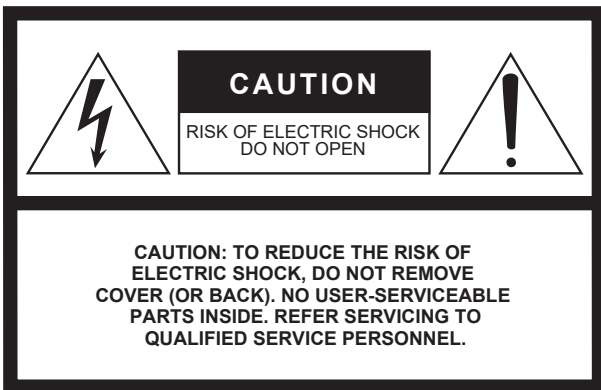

Explanation of Graphical Symbols

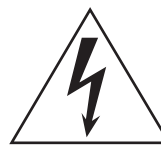

The lightning flash with arrowhead symbol within an equilateral triangle is intended to alert the user to the presence of uninsulated “dangerous voltage” within the product’s enclosure that may be of sufficient magnitude to constitute a risk of electric shock to persons.



The exclamation point within an equilateral triangle is intended to alert the user to the presence of important operating and maintenance (servicing) instructions in the literature accompanying the product.

IMPORTANT SAFETY INSTRUCTIONS

- 1 Read these instructions.
- 2 Keep these instructions.
- 3 Heed all warnings.
- 4 Follow all instructions.
- 5 Do not use this apparatus near water.
- 6 Clean only with dry cloth.
- 7 Do not block any ventilation openings. Install in accordance with the manufacturer’s instructions.
- 8 Do not install near any heat sources such as radiators, heat registers, stoves, or other apparatus (including amplifiers) that produce heat.
- 9 Do not defeat the safety purpose of the polarized or grounding-type plug. A polarized plug has two blades with one wider than the other. A grounding type plug has two blades and a third grounding prong. The wide blade or the third prong are provided for your safety. If the provided plug does not fit into your outlet, consult an electrician for replacement of the obsolete outlet.
- 10 Protect the power cord from being walked on or pinched particularly at plugs, convenience receptacles, and the point where they exit from the apparatus.

- 11 Only use attachments/accessories specified by the manufacturer.
- 12 Use only with the cart, stand, tripod, bracket, or table specified by the manufacturer, or sold with the apparatus. When a cart is used, use caution when moving the cart/apparatus combination to avoid injury from tip-over.
- 13 Unplug this apparatus during lightning storms or when unused for long periods of time.
- 14 Refer all servicing to qualified service personnel. Servicing is required when the apparatus has been damaged in any way, such as power-supply cord or plug is damaged, liquid has been spilled or objects have fallen into the apparatus, the apparatus has been exposed to rain or moisture, does not operate normally, or has been dropped.



WARNING

TO REDUCE THE RISK OF FIRE OR ELECTRIC SHOCK, DO NOT EXPOSE THIS APPARATUS TO RAIN OR MOISTURE.

(UL60065_03)

PRECAUTIONS

PLEASE READ CAREFULLY BEFORE PROCEEDING

Please keep this manual in a safe and handy place for future reference.

For the AC adaptor



WARNING

- This AC adaptor is designed for use with only Yamaha electronic devices. Do not use for any other purpose.
- Indoor use only. Do not use in any wet environments.



CAUTION

- When setting up, make sure that the AC outlet is easily accessible. If some trouble or malfunction occurs, immediately turn off the power switch of the instrument and disconnect the AC adaptor from the outlet. When the AC adaptor is connected to the AC outlet, keep in mind that electricity is flowing at the minimum level, even if the power switch is turned off. When you are not using the instrument for a long time, make sure to unplug the power cord from the wall AC outlet.

For the instrument



WARNING

Always follow the basic precautions listed below to avoid the possibility of serious injury or even death from electrical shock, short-circuiting, damages, fire or other hazards. These precautions include, but are not limited to, the following:

Power supply/AC adaptor

- Do not place the power cord near heat sources such as heaters or radiators. Also, do not excessively bend or otherwise damage the cord, or place heavy objects on it.
- Only use the voltage specified as correct for the instrument. The required voltage is printed on the name plate of the instrument.
- Use the specified adaptor (page 42) only. Using the wrong adaptor can result in damage to the instrument or overheating.
- Check the electric plug periodically and remove any dirt or dust which may have accumulated on it.
- Unplug the power cord from the AC outlet when cleaning the instrument.

Do not open

- This instrument contains no user-serviceable parts. Do not open the instrument or attempt to disassemble or modify the internal components in any way. If it should appear to be malfunctioning, discontinue use immediately and have it inspected by qualified Yamaha service personnel.

Water warning

- Do not expose the instrument to rain, use it near water or in damp or wet conditions, or place on it any containers (such as vases, bottles or glasses) containing liquids which might spill into any openings. If any liquid such as water seeps into the instrument, turn off the power immediately and unplug the power cord from the AC outlet. Then have the instrument inspected by qualified Yamaha service personnel.
- Never insert or remove an electric plug with wet hands.

Fire warning

- Do not put burning items, such as candles, on the unit. A burning item may fall over and cause a fire.

If you notice any abnormality

- When one of the following problems occur, immediately turn off the power switch and disconnect the electric plug from the outlet. Then have the device inspected by Yamaha service personnel.
 - The power cord or plug becomes frayed or damaged.
 - It emits unusual smells or smoke.
 - Some object has been dropped into the instrument.
 - There is a sudden loss of sound during use of the instrument.

CAUTION

Always follow the basic precautions listed below to avoid the possibility of physical injury to you or others, or damage to the instrument or other property. These precautions include, but are not limited to, the following:

Power supply/AC adaptor

- Do not connect the instrument to an electrical outlet using a multiple-connector. Doing so can result in lower sound quality, or possibly cause overheating in the outlet.
- When removing the electric plug from the instrument or an outlet, always hold the plug itself and not the cord. Pulling by the cord can damage it.
- Remove the electric plug from the outlet when the instrument is not to be used for extended periods of time, or during electrical storms.

Location

- Do not place the instrument in an unstable position where it might accidentally fall over.
- Before moving the instrument, remove all connected cables, to prevent damage to the cables or injury to anyone who might trip over them.
- When moving the instrument, be careful to avoid catching your hands or feet on the instrument.
- Move the instrument slowly with extra care to keep the instrument from falling over, or bumping against the surroundings. We recommend that you consult a qualified carrier to transport or move the instrument.
- When setting up the product, make sure that the AC outlet you are using is easily accessible. If some trouble or malfunction occurs, immediately turn off the power switch and disconnect the plug from the outlet. Even when the power switch is turned off, electricity is still flowing to the product at the minimum level. When you are not using the product for a long time, make sure to unplug the power cord from the wall AC outlet.

Connections

- Before connecting the instrument to other electronic components, turn off the power for all components. Before turning the power on or off for all components, set all volume levels to minimum.
- Be sure to set the volumes of all components at their minimum levels and gradually raise the volume controls while playing the instrument to set the desired listening level.

Handling caution

- Do not insert a finger or hand in any gaps on the fallboard or instrument. Also take care that the fallboard does not pinch your finger.
- Never insert or drop paper, metallic, or other objects into the gaps or opening on the main unit, fallboard, or keyboard. This could cause physical injury to you or others, damage to the instrument or other property, or operational failure.
- Do not rest your weight on, or place heavy objects on the instrument, and do not use excessive force on the buttons, switches or connectors.
- Do not use the instrument/device or headphones for a long period of time at a high or uncomfortable volume level, since this can cause permanent hearing loss. If you experience any hearing loss or ringing in the ears, consult a physician.
- Close the fallboard when the instrument is not in use. Hold the fallboard with both hands when opening or closing it. Be careful to avoid catching fingers (yours or others) between the fallboard and the main unit.
- Do not go near the instrument during an earthquake. Strong shaking during an earthquake could cause the instrument to move or tip over, resulting in damage to the instrument or its parts, and possibly causing injury.

Yamaha cannot be held responsible for damage caused by improper use or modifications to the instrument, or data that is lost or destroyed.

Always turn the power off when the instrument is not in use.

Even when the [] (Standby/On) switch is in standby status (power lamp is off), electricity is still flowing to the instrument at the minimum level.

When you are not using the instrument for a long time, make sure you unplug the power cord from the wall AC outlet.

NOTICE

To avoid the possibility of malfunction/ damage to the product, damage to data, or damage to other property, follow the notices below.

■ Handling

- Do not connect this product to public Wi-Fi and/ or Internet directly. Only connect this product to the Internet through a router with strong password-protections. Consult your router manufacturer for information on security best practices.
- Do not use the instrument in the vicinity of a TV, radio, stereo equipment, mobile phone, or other electric devices. Otherwise, the instrument, TV, or radio may generate noise. When you use the instrument along with a smart device, such as an iPhone, iPad, etc., we recommend that you set that device's "Airplane Mode" to on and then the Wi-Fi setting to on in order to avoid noise caused by communication.
- Do not expose the instrument to excessive dust or vibrations, or extreme cold or heat (such as in direct sunlight, near a heater, or in a car during the day) to prevent the possibility of panel disfiguration, damage to the internal components or unstable operation.
- Do not place vinyl, plastic or rubber objects on the instrument, since this might discolor the panel or keyboard.
- Bumping the surface of the instrument with metal, porcelain, or other hard objects can cause the finish to crack or peel. Use caution.
- Do not drag the instrument when moving it. Doing so may damage the floor.

■ Maintenance

- When cleaning the instrument, use a soft and dry cloth. Do not use paint thinners, solvents, alcohol, cleaning fluids, or chemical-impregnated wiping cloths.
- Gently remove dust and dirt with a soft cloth. Do not wipe too hard since small particles of dirt can scratch the instrument's finish.
- During extreme changes in temperature or humidity, condensation may occur and water may collect on the surface of the instrument. If water is left, the wooden parts may absorb the water and be damaged. Make sure to wipe any water off immediately with a soft cloth.

■ Saving data

- The MIDI Song recorded to this instrument (page 22) are retained when the power is turned off. However, the saved data may be lost due to some failure, an operation mistake, etc. Save your

important data onto an external device such as a computer (page 31).

- To protect against data loss through USB flash drive damage, we recommend that you save your important data onto spare USB flash drive or an external device such as a computer as backup data.

Information

■ About copyrights

- Copying of the commercially available musical data including but not limited to MIDI data and/or audio data is strictly prohibited except for your personal use.
- This product incorporates and bundles contents in which Yamaha owns copyrights or with respect to which Yamaha has license to use others' copyrights. Due to copyright laws and other relevant laws, you are NOT allowed to distribute media in which these contents are saved or recorded and remain virtually the same or very similar to those in the product.
 - * The contents described above include a computer program, Accompaniment Style data, MIDI data, WAVE data, voice recording data, a score, score data, etc.
 - * You are allowed to distribute medium in which your performance or music production using these contents is recorded, and the permission of Yamaha Corporation is not required in such cases.

■ About functions/data bundled with the instrument

- Some of the preset songs have been edited for length or arrangement, and may not be exactly the same as the original.

■ About this manual

- The illustrations as shown in this manual are for instructional purposes only, and may appear somewhat different from those on your instrument.
- Windows is a registered trademark of Microsoft® Corporation in the United States and other countries.
- iPhone, iPad and iPod touch are trademarks of Apple Inc., registered in the U.S. and other countries.
- The company names and product names in this manual are the trademarks or registered trademarks of their respective companies.

Thank you for choosing the Yamaha Silent Piano™. This instrument is equipped with the same keyboard mechanisms as an acoustic piano. However, you can play with the sound muted, and use various functions not available on an acoustic piano, such as changing Voices or recording your performance. This manual mainly explains these functions as a Silent Piano. In order to make the most of the performance potential and features of the instrument, please read the manuals thoroughly, and keep them in a handy place for later reference.

About the Manuals

This instrument has the following documents and instructional materials.

■ Included Documents



Owner's Manual (this book)

This manual mainly describes how to use the particular functions for the Silent Piano™ which can be used when the power is turned on. For information on handling as an acoustic piano, refer to the separate manual for the piano.

Quick Operation Guide (page 44)

This a quick reference for operation of the functions assigned to the buttons and keyboard.

■ Online Materials (downloadable from the website)



iPhone/iPad Connection Manual (only in English, French, German and Spanish)

Explains how to connect the instrument to smart devices, such as an iPhone, iPad, etc.



Computer-related Operations

Includes instructions on connecting this instrument to a computer, and operations related to transferring data.



MIDI Reference

Contains MIDI related information.

To obtain these manuals, access the Yamaha Downloads, enter the model name for searching the desired files.

Yamaha Downloads

<https://download.yamaha.com/>

Included Accessories

- Owner's Manual (this book) x 1
- AC adaptor x 1
- Power cord x 1
- Headphones x 1
- Headphone hanger x 1
- Attachment screws for headphone hanger x 2

Features

- **Silencing System enables you play in any situation, at any time you want**

Yamaha's innovative silencing system brings you superior performance, yet with virtually complete silence. Enjoy your performance just as if you were playing an acoustic piano—but without the need to worry about bothering people around you.

- **Non-contact sensors for maximum expressiveness**

The non-contact optical sensors faithfully detect subtle movement of the keys without affecting the touch of the keys. They catch keystroke information precisely, enabling you to perform with rich nuance and extraordinarily subtle expression.

- **Elegant, integrated design**

The control unit has been given a graceful design that unobtrusively blends with the piano itself. Moreover, the simple controllers allow you to operate the instrument easily.

- **Realistic ambience of the Voices enhances your performance**

This instrument puts the sound of ten luxurious, authentic Voices at your fingertips. These include Yamaha's flagship CFX piano—which delivers dynamic sound, from a brilliant high-range to powerful bass—and the Bösendorfer* Imperial, a world-class piano renowned for its subtle and warm sound. The instrument also features advanced technologies such as Binaural Sampling. Listening with headphones to a piano Voice enhanced through these methods gives the impression of being thoroughly immersed in the sound, as if it was actually emanating from the piano.

Altogether, it delivers real sound faithful to that of an actual acoustic piano, such as the quick attack and the graceful resonance of a sustained piano tone, as well as how the sound responds to your playing strength, and the resonance effect when the damper pedal is pressed.

* Bösendorfer is a subsidiary company of Yamaha.

- **Playback and recording functions for aid in learning and practice**

You can record your performance to this instrument and a USB flash drive, and improve your performance by listening back to the recording.

Smart Device App “Smart Pianist”

The smart device app “Smart Pianist” (available as a free download) enables you to use the functions such as selecting Voices, controlling the metronome intuitively with the visualized interface, or display the score on your smart device.

For information about this app, access the following web page:

<https://www.yamaha.com/kbdapps/>

The connection wizard of the Smart Pianist helps you to connect this unit to your smart device properly. To start connection wizard, tap [☰] (Menu) located upper left on the Smart Pianist screen to open the menu, then tap “Instrument” followed by “Start Connection Wizard.”

Getting Started

Part names

■ Piano

Upright Piano

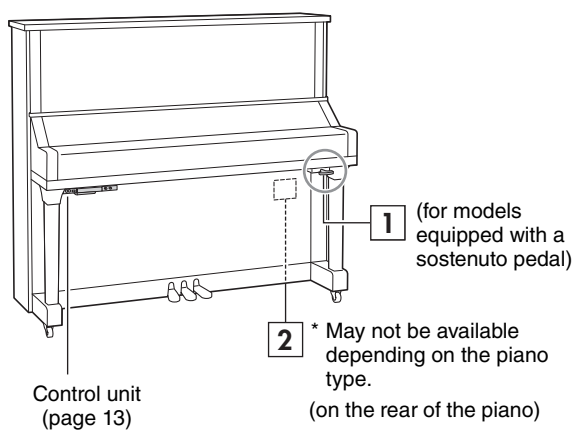

Grand Piano

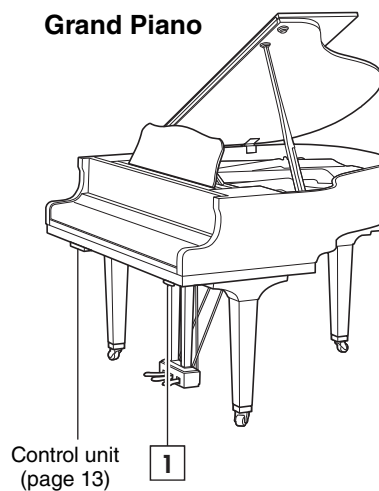

1 Silencing lever (page 16)

Activates the Silent Piano™ function.

2 DC IN jack (page 14)

For connecting the supplied AC adaptor.

■ Pedals

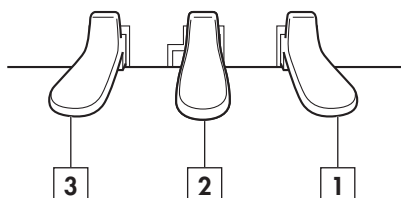

1 Damper pedal

Sustains notes even after you release the keys. When the Silent Piano™ function is enabled and a piano Voice is selected, pressing this pedal reproduces the complicated interaction of both strings and soundboard resonance by the VRM technology (page 37), and makes the sound more like a real acoustic piano.

The damper pedal features an expressive half-pedal function, and allows you to set the degree to which pressing the damper pedal applies the half-pedal effect (page 35), when using the Silent Piano™ function.

2 Upright Piano

Silencing pedal (For models not equipped with a sostenuto pedal)

Activates the Silent Piano™ function by pressing and sliding to the left.

Sostenuto pedal (For models equipped with a sostenuto pedal)

Sustains the notes that are being played at the time you press and hold the pedal, even after you release the keys, letting you play additional non-sustained notes. Subsequently played notes are not affected.

Grand Piano

Sostenuto pedal / Bass sustain pedal

When using the Silent Piano function, there is no Sostenuto effect.

NOTE

Either sostenuto or bass sustain function is installed depending on your area.

3 Soft pedal

Reduces the volume and slightly changes the timbre of the notes. The notes played before this pedal is pressed are not affected.

■ Control unit

Front panel

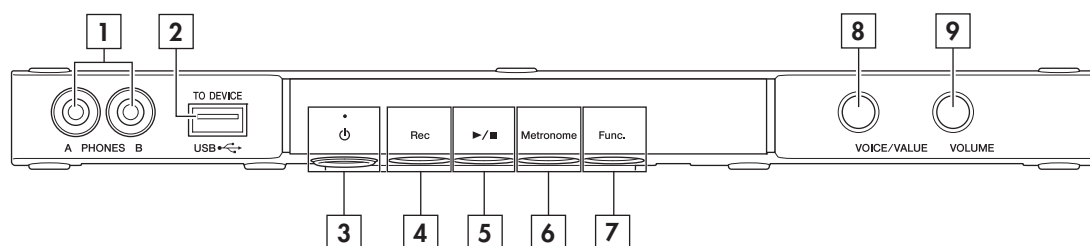

Bottom panel

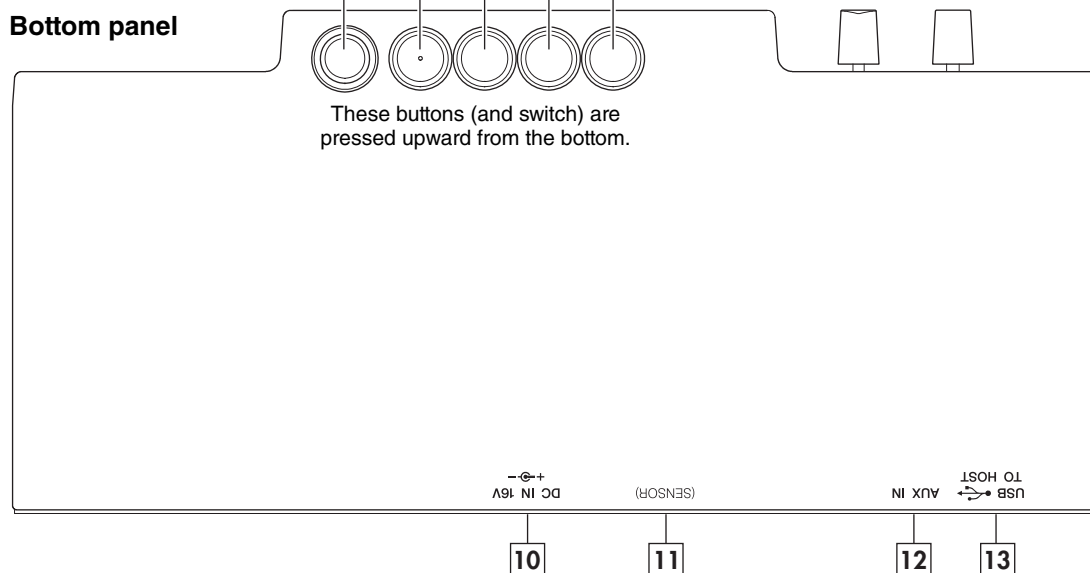

- 1 [PHONES] jacks (page 15)**
For connecting a pair of headphones (stereo mini plug). Up to two headphones can be connected.
- 2 USB [TO DEVICE] terminal (page 25)**
For connecting a USB flash drive or a USB wireless LAN adaptor.
- 3 [⏻] (Standby/On) switch (page 14)**
For turning the power on or setting to standby.
- 4 [Rec] button (page 22)**
For setting the unit to recording standby status. The lamp indicates the recording status.
- 5 [▶/■] (Play/Stop) button (page 23)**
For alternately playing back and stopping the preset Songs or your recorded performance. The lamp indicates the playback status.
- 6 [Metronome] button (page 19)**
For controlling the metronome. The lamp indicates the metronome status.
- 7 [Func.] button (page 33)**
For making settings of various functions.
- 8 [VOICE/VALUE] control**
Rotating this allows you to select desired Voices or adjust the setting values. Pressing this control resets the Voice or setting values.
- 9 [VOLUME] control (page 16)**
For adjusting the volume of the entire sound output from the [PHONES] jack.
- 10 [DC IN 16V] jack (page 14)**
For connecting to the power. The power cord may already be connected to the DC IN jack on the rear of the piano when the piano is shipped, depending on the piano type.
- 11 [SENSOR] jack**
(For qualified Yamaha personnel only.) This connects to the sensor. The plug is already connected when the instrument is shipped.
- 12 [AUX IN] jack (page 30)**
For connecting an audio device such as a portable music player by using an audio cable with stereo mini plugs.
- 13 USB [TO HOST] terminal (page 31)**
For connecting to a computer or a smart device.

Turning the power on/off

1 Connect the plugs of the AC adaptor in the order shown in the illustration.

Depending on the piano type, the DC IN jack is located at either of the following positions. Make sure to loop the power cord through the hook attached to the rear of the piano or behind the control unit.

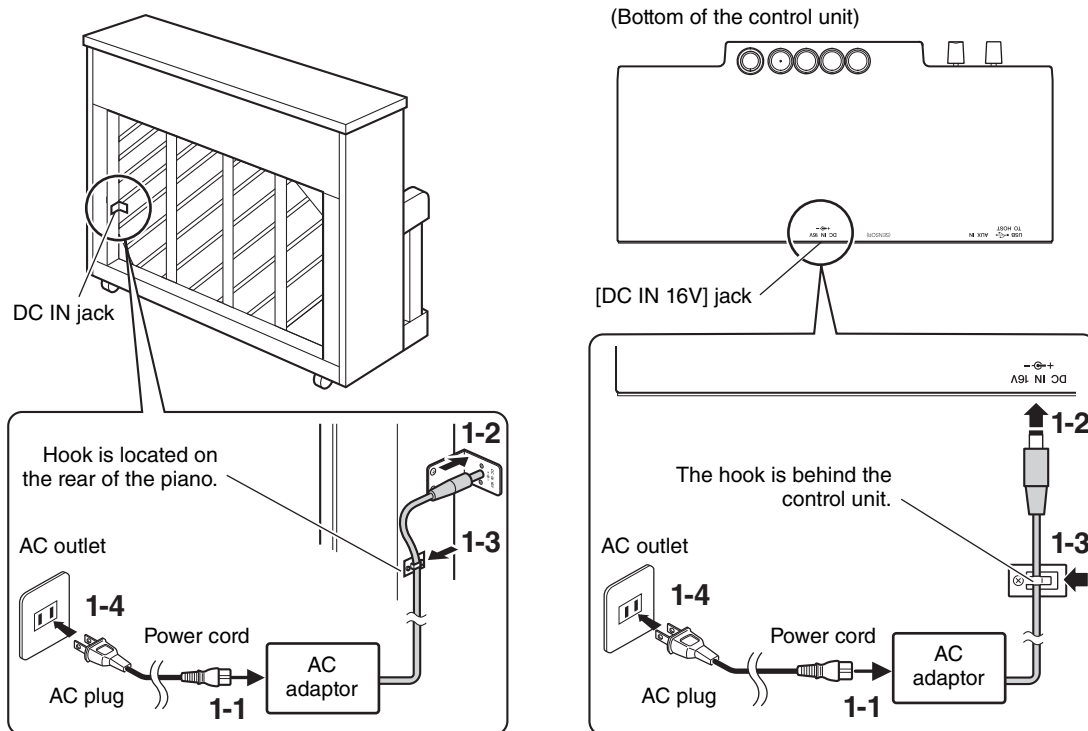

⚠ WARNING

Use the specified adaptor (page 42) only. Use of other adaptors may result in irreparable damage to both the adaptor and the instrument.

⚠ CAUTION

When setting up the product, make sure that the AC outlet you are using is easily accessible. If some trouble or malfunction occurs, immediately turn the power off and disconnect the plug from the outlet.

NOTE

When disconnecting the AC adaptor, first turn the power off, and then follow the order shown above in reverse.

2 Press the [⏻] (Standby/On) switch to turn the power on.

The [⏻] (Standby/On) lamp lights up. To turn the power off, press the switch again.

NOTE

The sound will not be properly output if a key was pressed when the power was turned on. Do not touch any keys when turning the power on.

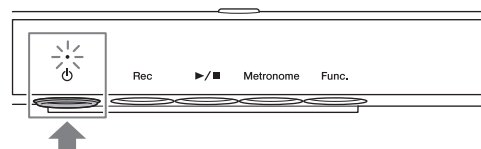

⚠ CAUTION

Even when the instrument is turned off, electricity is still flowing to the instrument at the minimum level. When you are not using the instrument for a long time or during electrical storms, make sure you unplug the AC power plug from the wall AC outlet.

Auto Power Off function

To prevent unnecessary power consumption, this unit features an Auto Power Off function that automatically turns the power off if the instrument is not operated for 30 minutes.

NOTICE

When the instrument is communicating with other devices, the power will not be turned off automatically. Make sure to turn off the power by pressing the [⏻] (Standby/On) switch when the instrument is not in use.

Disabling Auto Power Off

Turn the power on while holding down the lowest key (A-1). After a brief time, the [Rec] lamp flashes three times and the unit starts up with the Auto Power Off function disabled.

To turn the Auto Power Off function on or off while the power is on, refer to page 38.

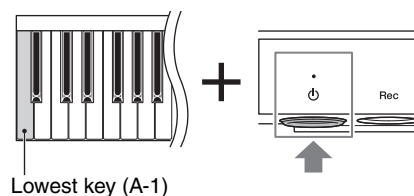

Using headphones

Connect a pair of headphones to the [PHONES] jack. Since this instrument is equipped with two [PHONES] jacks, you can connect two pairs of headphones. If you are using only one pair, insert the plug into either of these jacks.

Even when listening through headphones, you can enjoy exceptionally realistic, natural sound by Yamaha's advanced technologies, Binaural Sampling and Stereophonic Optimizer. For details, refer to page 18.

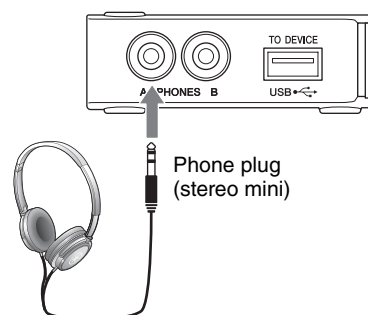

⚠ CAUTION

- Do not use the headphones for a long period of time at a high or uncomfortable volume level, since this can cause permanent hearing loss.
- Be careful not to catch your foot on the headphone cord.

NOTICE

Do not pull the cord of the headphones or apply excessive force on the plug. This can damage the headphones and result in sound degradation.

Using an external speaker

The [PHONES] jack can also be used for external output. By connecting a powered speaker to the [PHONES] jack, you can output the sound from this instrument to an external speaker and let other people hear it.

NOTICE

To avoid possible damage to the devices, first turn on the power to the instrument, then to the external device. When turning off the power, first turn off the power to the external device, then to the instrument.

■ Attaching the headphone hanger

Attach the headphone hanger to the bottom of the control unit with the supplied two screws.

NOTICE

Do not hang anything other than the headphones on the hanger. Otherwise, the instrument or the hanger may be damaged.

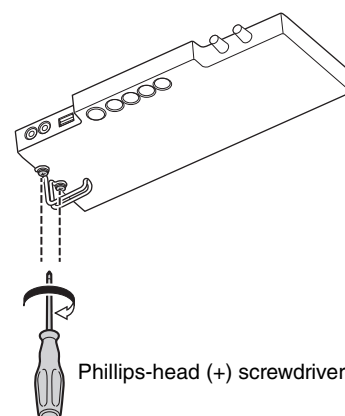

Playing with the Silent Piano™ Function

This instrument can be played both as a normal acoustic piano, and also as a Silent Piano™. Enabling the Silent Piano™ function lets you take advantage of a variety of powerful functions—such as playing preset Voices built into unit and recording your performances. Try out the Silent Piano™ function and explore the possibilities.

Using the Silent Piano™ function

1 Plug the headphones into the [PHONES] jack (page 15).

2 Rotate the [VOLUME] control to the far-left position to set the volume to minimum.

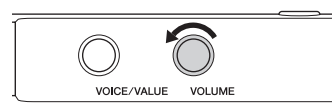

3 Press the [⏻] (Standby/On) switch to turn the power on.

4 (For models equipped with a sostenuto pedal)
Pull the silencing lever towards you until you hear a click and feel the mechanism catch.

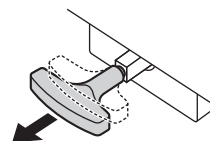

(For models not equipped with a sostenuto pedal)
Press the center pedal and slide it to the left.

This prevents the hammers from actually striking the strings.

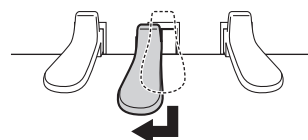

5 While playing the keyboard, adjust the volume level by rotating the [VOLUME] control.

Rotating to the right increases the volume, while rotating to the left decreases it.

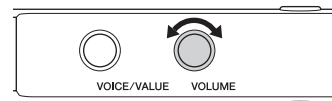
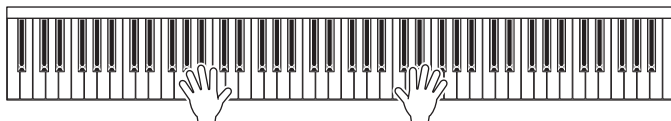

NOTE

The physical sound of the keyboard mechanism remains even when the Silent Piano™ function is active.

Selecting Voices

When the Silent Piano™ function is enabled, you can select and play the various built-in preset Voices from the keyboard. By default, the CFX Grand is always selected when the power is turned on.

To select a Voice other than the CFX Grand:

Rotate the [VOICE/VALUE] control step by step to switch the Voice to the next or previous one in the order of the Voice List below.

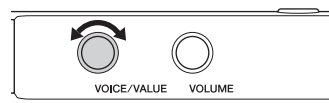

To reset to the CFX Grand Voice:

Press the [VOICE/VALUE] control.

NOTE

- You can change various settings such as Reverb type and depth, Touch Sensitivity, tuning and brilliance (page 33).
- To hear and experience the characteristics of the Voices, listen to the Demo Songs for each Voice (page 26).
- Changing the Voice while pressing the keyboard may cause a sudden large change in the volume.

■ Voice List

Voice Name		Description	Stereo Sampling	Touch Sensitivity	Key-off Sampling	VRM
Piano						
1	Binaural CFX Grand	Yamaha's CFX concert grand piano sound sampled by Binaural Sampling, the method optimized for headphone use. Listening this through headphones gives the impression of being immersed in the sound, as if it was actually emanating from the piano. This is available when the Binaural setting is turned on (page 37).	✓	✓	✓	✓
	CFX Grand	Yamaha's CFX concert grand piano sound with a wide dynamic range for maximum expressive control. Suitable for playing in any music genre and style. This is available when the Binaural setting is turned off (page 37).	✓	✓	✓	✓
2	Bösendorfer Imperial	The famed sound of the Vienna-made Bösendorfer Imperial concert grand piano. Its spacious sound evokes the size of the instrument, and is ideal for expressing tenderness in compositions.	✓	✓	✓	✓
3	Upright Piano	The sound sampled from an upright piano, the Yamaha SU7. Enjoy the unique tonal character and a lighter, more casual feel.	✓	✓	--	✓
E. Piano						
4	Stage E.Piano	The sound of an electric piano using hammer-struck metallic "tines." A soft tone results when played lightly, and an aggressive tone when played hard.	--	✓	✓	--
5	DX E.Piano	An electronic piano sound produced by an FM synthesizer. The tone will change as you vary your playing touch. Ideal for popular music.	--	✓	--	--
6	Vintage E.Piano	A different type of electric piano sound than Stage E. Piano. Widely used in rock and popular music.	--	✓	✓	--

Voice Name	Description	Stereo Sampling	Touch Sensitivity	Key-off Sampling	VRM	
Harpichord						
7	Harpichord 8'	The sound of an instrument frequently used in baroque music. Variations in playing touch will not affect the volume, and a characteristic sound will be heard when you release the key.	✓	--	✓	--
8	Celesta	The sound of a celesta (a percussion instrument in which hammers strike tuned metal bars). This instrument is well-known for its appearance in "Dance of the Sugarplum Fairies" from Tchaikovsky's "Nutcracker Suite."	✓	✓	--	--
Organ						
9	Organ Principal	This Voice features the combination of pipes (8'+4'+2') of the principal setting (brass emulation) on a pipe organ. It is suitable for Baroque church music.	✓	--	--	--
10	Jazz Organ	The sound of a "tonewheel" type electric organ. Sampled with a Rotary SP effect, its rotation speed is slow. Often heard in jazz and rock idioms.	--	--	--	--

The cells marked by "✓" indicate the available characteristics (which are explained below) for the Voice.

- **Stereo Sampling:** Stereo sampling is used for the Voice.
- **Touch Sensitivity:** The volume responds to your playing strength.
- **Key-off Sampling:** The key-off sound (the subtle sound that occurs when you release a key) is sampled for the Voice.
- **VRM:** Simulated string resonance sound with physical modeling when the damper pedal is pressed or keys are pressed. This can be turned on or off. For details, refer to page 37.

■ Reproducing a natural sound distance sensation (even when using headphones)—Binaural Sampling and Stereophonic Optimizer

This instrument features two advanced technologies that allow you to enjoy exceptionally realistic, natural sound, even though listening on headphones. These functions can be turned on or off as desired (page 37).

Binaural Sampling (CFX Grand Voice only)

Binaural Sampling is a method that uses two special microphones set at the ear position of a performer and records the sound from a piano as it would actually be heard. Listening to the sound with this effect through headphones gives the impression of being immersed in the sound, as if it was actually emanating from the piano. When the CFX Grand Voice is selected, binaural sampled sound is produced.

Stereophonic Optimizer (Piano Voices other than CFX Grand)

Stereophonic Optimizer is an effect which reproduces the natural sound distance, like with the sound of Binaural Sampling, even though you are listening to it on headphones. When one of the Piano Voices other than CFX Grand is selected, the Stereophonic Optimizer is enabled.

Using the metronome

The unit features a built-in metronome that helps you to practice and play with accurate tempo.

1 Press the [Metronome] button to start the metronome.

While the metronome sounds, the [Metronome] lamp flashes in orange at the current tempo.

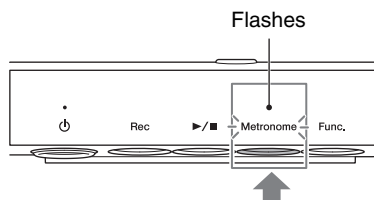

NOTE

When a MIDI Song (page 23) is played back, the metronome plays according to the Song tempo and time signature.

2 Press the [Metronome] button again to stop the metronome.

■ Selecting the time signature (Beat)

While holding down the [Metronome] button, press one of the C3 – F3 keys, to select the number of beats in a measure. For values other than 0, the first beat is accented with a bell sound to signal the start of a measure.

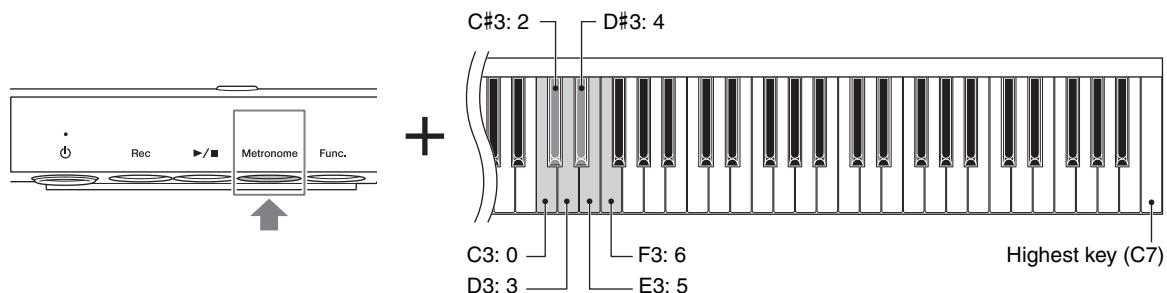

Default setting: 0 (no 1st beat accent)

NOTE

- One beat is equal to a quarter note on this unit. When playing a song written in non- quarter-note units, change the setting accordingly (for example, when playing a song in 3/2 time, set Beat to 6).
- The metronome beat is automatically reset to the default value when the power is turned off.

■ Voice confirmation of current tempo value (in English)

While holding down the [Metronome] button, press the lowest key (A-1).

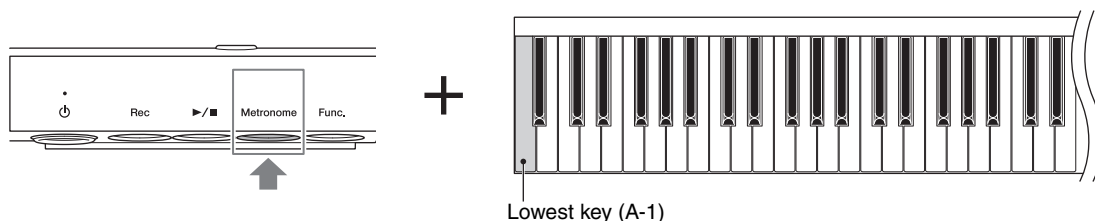

■ Adjusting the tempo

The metronome tempo can be set from 5 to 500 beats per minute by one of the following methods.

NOTE

The metronome tempo restores to its default setting when the power is turned off.

- **To adjust by rotating the [VOICE/VALUE] control:**

While holding down the [Metronome] button, rotate the [VOICE/VALUE] control.

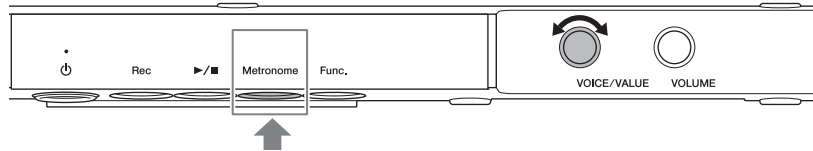

NOTE

When the Audio Song is being played back, this operation changes the playback speed (page 29). The metronome tempo does not change.

- **To specify a three-digit value:**

While holding down the [Metronome] button, press the relevant C0 – A0 keys one by one in order. For example to specify “95,” press the A0 (0), G#0 (9) and E0 (5) keys in order. A numeric value is read out in English when a relevant key is pressed.

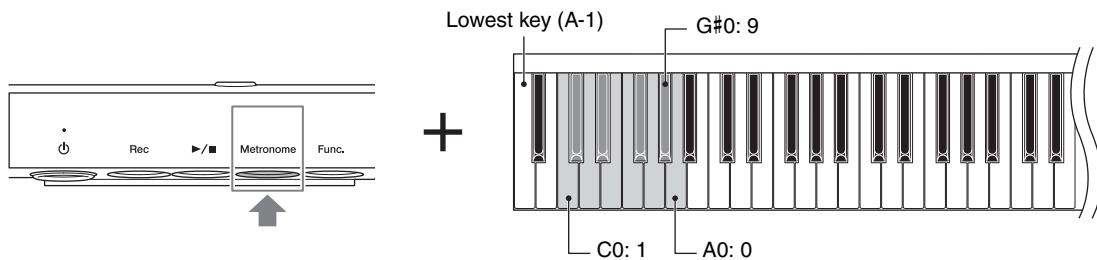

- **To increase or decrease the value by 1 or 10:**

While holding down the [Metronome] button, press one of the keys shown below.

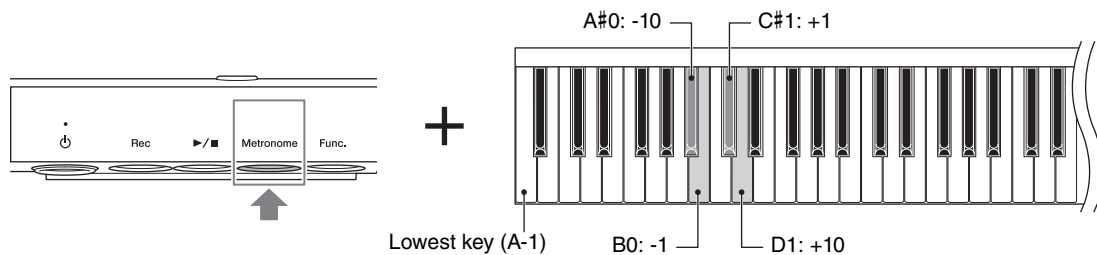

- **To reset the value to the default:**

While holding down the [Metronome] button, press the C1 key.

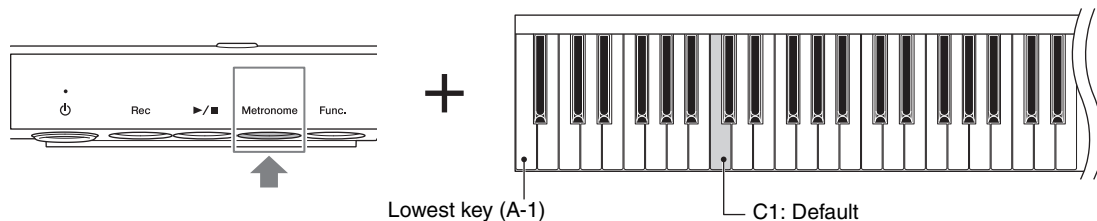

You can also reset the value by pressing the [VOICE/VALUE] control while holding down the [Metronome] button.

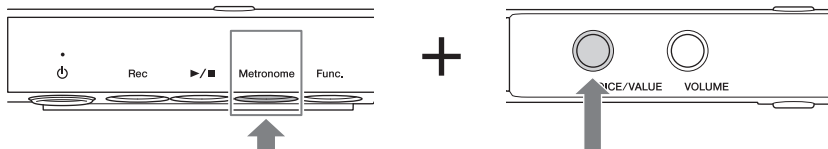

■ Adjusting the metronome volume

While holding down the [Metronome] button, press one of the C4 – G5 keys to set the metronome volume. The higher the key, the higher the volume level.

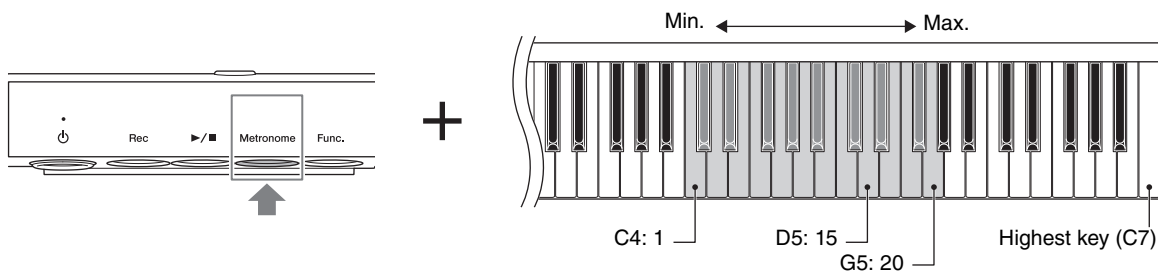

Default setting: 15 (D5)

Recording and Playback

This instrument allows you to record your performance by using one of the following two methods. The recorded performance can be played back and saved for use with other devices.

MIDI recording

With this method, your keyboard performances are recorded and saved to internal memory of this unit as a MIDI Song (SMF format 0). In a MIDI song, the information of your keyboard performance (such as keystroke and velocity) is recorded. This is not a recording of the actual sound. Information such as the selected Voice, Beat and Tempo is also recorded to the MIDI Song. The recorded MIDI Song can be transmitted and saved to a computer (page 31).

Audio recording

With this method, your keyboard performances are recorded then saved to USB flash drive as an Audio Song in stereo WAV format of normal CD-quality resolution (44.1 kHz/16 bit, stereo). The saved Audio Song can be transmitted to and played on portable music players.

NOTE

You can use the metronome (page 19) while recording, although the metronome sound will not be recorded.

Recording your performance to internal memory (MIDI recording)

One Song can be recorded in the MIDI format to the internal memory of this unit. The recorded MIDI Song is maintained in the internal memory even when the power is turned off.

NOTICE

Note that recording to internal memory will overwrite any previously recorded data. To prevent your important data from being overwritten and erased, save the necessary data to a computer (page 31).

NOTE

- This instrument can record up to approximately 500 KB (approx. 55,000 notes). This is equivalent to about 40 minutes for conventional songs. However, frequent use of the pedals or changing of Voices while playing may cause the recording time to be shortened to five minutes.
- You cannot start recording during Song playback. Make sure to stop playback beforehand.

1 Disconnect the USB flash drive from this unit, if it is connected.

You cannot record to the internal memory when a USB flash drive is connected to the unit.

2 Press the [Rec] button to put recording in standby.

The [Rec] lamp lights in red, and the [▶/■] (Play/Stop) lamp flashes in orange.

NOTE

To cancel recording standby status, press the [Rec] button again. If you cancel recording and exit from recording standby status, the previously recorded data will be maintained.

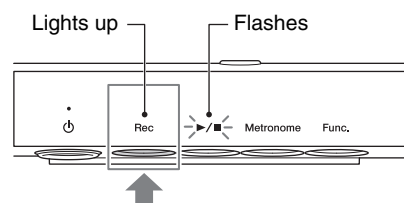

3 Play the keyboard or press the [▶/■] (Play/Stop) button to start recording.

The [▶/■] (Play/Stop) lamp stops flashing and lights continuously.

NOTICE

If the [Rec] lamp flashes in red while or after recording, it indicates the internal memory capacity has become full and all or the part of the data will not be saved.

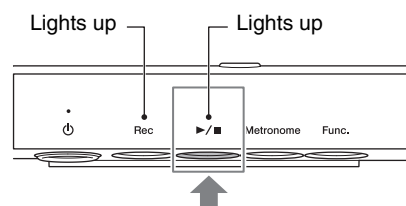

4 Press the [▶/■] (Play/Stop) button or the [Rec] button to stop recording.

The [▶/■] (Play/Stop), [Metronome] and [Func.] lamps light up in orange in sequence and the performance data will be saved. All lamps light in white when saving of the data is completed.

While saving

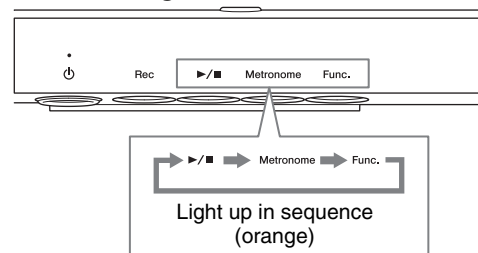

NOTICE

Do not turn the power off until all lamps light up in white as this may corrupt the data or damage internal memory.

Playing back the MIDI Song recorded to internal memory

The MIDI Song recorded to the internal memory cannot be played back when a USB flash drive is connected to the unit. Make sure to disconnect the USB flash drive in advance.

1 Press the [▶/■] (Play/Stop) button to start playback.

The [▶/■] (Play/Stop) button lights up in orange while playing back. Pressing the button again stops playback.

When the Song comes to the end, playback stops automatically.

NOTE

- For details on playback operations, refer to page 28.
- If there is no Song recorded to internal memory, no MIDI Song is played back when the [▶/■] button is pressed.

During playback

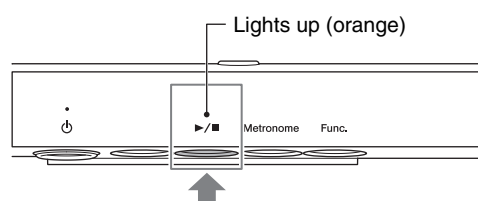

Recording your performance to a USB flash drive (Audio recording)

When a USB flash drive is connected to this unit, you can record up to 100 Audio Songs (max. 80 minutes per Song).

NOTE

Before using the USB flash drive, make sure to read “Connecting USB devices” on page 25.

1 Connect a USB flash drive to the USB [TO DEVICE] terminal at the front of the control unit.

2 Record your performance.

The operation is the same as recording to internal memory. For details, refer to “Recording your performance to internal memory (MIDI recording)” on page 22.

The recorded Audio Song will be named “USERAUDIO**.WAV” (**: 00 – 99) and saved in the “USER FILES” folder in the USB flash drive.

NOTICE

The number in the file name increases each time you record, and when it reaches to “USERAUDIO99.WAV,” the next recording overwrites “USERAUDIO99.WAV.” To prevent your important data from being overwritten and erased, copy the necessary data to a computer.

Even when vacant numbers (file name) exist in the USB flash drive by changing the file names or deleting files on a computer, the recorded data is always named according to the largest number.

NOTE

The audio input from external devices, such as a computer or a smart device (connected via the [AUX IN] jack, USB [TO HOST] terminal or wireless LAN), can also be recorded. For connection with these devices, refer to page 30.

Playing back an Audio Song recorded to the USB flash drive

An Audio Song on USB flash drive can be played back on this instrument, but keep in mind that only the last-recorded Song (largest numbered file name) can be played. If you want to play back other Songs, use another audio device, such as a computer or portable music player.

1 Connect the USB flash drive containing the desired Audio Song to the USB [TO DEVICE] terminal.

2 Press the [▶/■] (Play/Stop) button to start playback.

The [▶/■] (Play/Stop) button lights up in orange while playing back. Pressing the button again stops playback.

When the Song comes to the end, playback stops automatically.

NOTE

- For details on playback operations, refer to page 28.
- If you move the file outside of the “USER FILES” folder or change the file name to something other than “USERAUDIO**.WAV” (**: 00 – 99), the Audio Song cannot be played back on this unit.

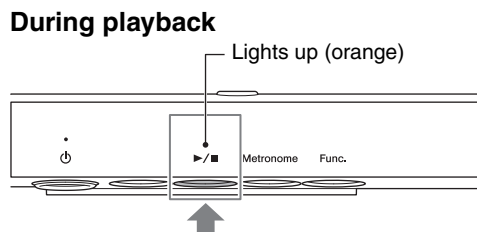

Connecting USB devices

You can connect a USB flash drive or a USB wireless LAN adaptor (sold separately) to the USB [TO DEVICE] terminal. You can record your performance to the USB flash drive (page 22), or you can connect the instrument to a smart device via wireless LAN (page 31).

Precautions when using the USB [TO DEVICE] terminal

This instrument features a built-in USB [TO DEVICE] terminal. When connecting a USB device to the terminal, be sure to handle the USB device with care. Follow the important precautions below.

NOTE

For more information about the handling of USB devices, refer to the owner's manual of the USB device.

■ Compatible USB devices

- USB flash drive
- USB hub
- USB wireless LAN adaptor (UD-WL01; may not be available depending on your area)

Other USB devices such as a USB hub, computer keyboard or mouse cannot be used.

The instrument does not necessarily support all commercially available USB devices. Yamaha cannot guarantee operation of USB devices that you purchase. Before purchasing a USB device for use with this instrument, please visit the following web page: <http://download.yamaha.com/>

Although USB devices 2.0 to 3.0 can be used on this instrument, the amount of time for saving to or loading from the USB device may differ depending on the type of data or the status of the instrument. USB 1.1 devices cannot be used on this instrument.

NOTICE

The rating of the USB [TO DEVICE] terminal is a maximum of 5V/500mA. Do not connect USB devices having a rating above this, since this can cause damage to the instrument itself.

■ Connecting a USB device

When connecting a USB device to the USB [TO DEVICE] terminal, make sure that the connector on the device is appropriate and that it is connected in the proper direction.

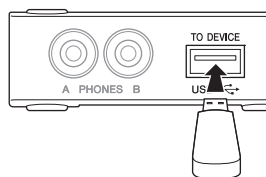

NOTICE

- Avoid connecting or disconnecting the USB device during playback/recording, or when accessing the USB device. Failure to observe this may result in "freezing" of the operation of the instrument or corruption of the USB device and the data.
- When connecting then disconnecting the USB device (and vice versa), make sure to wait a few seconds between the two operations.

NOTE

- If you intend to connect two or three devices at the same time to a terminal, you should use a bus-powered USB hub. Only one USB hub can be used. If an error message appears while using the USB hub, disconnect the hub from the instrument, then turn on the power of the instrument and re-connect the USB hub.
- Do not use an extension cable when connecting a USB device.

Using USB flash drives

By connecting the instrument to a USB flash drive, you can save data you've recorded to the connected device, as well as read data from the connected USB flash drive.

■ Number of USB flash drives that can be used

Only one USB flash drive can be connected to the USB [TO DEVICE] terminal. (If necessary, use a USB hub. The number of USB flash drives that can be used simultaneously with musical instruments even when a USB hub is used is only one.)

■ Formatting a USB flash drive

You should format the USB flash drive (to the FAT file system) by using a computer.

NOTICE

The format operation overwrites any previously existing data. Make sure that the USB flash drive you are formatting does not contain important data.

■ To protect your data (write-protect)

To prevent important data from being inadvertently erased, apply the write-protect provided with each USB flash drive. If you are saving data to the USB flash drive, make sure to disable write-protect.

■ Turning off the instrument

When turning off the instrument, make sure that the instrument is NOT accessing the USB flash drive by playback/recording. Failure to do so may corrupt the USB flash drive and the data.

Playing back the Voice Demo Songs

The Demo Songs effectively showcase the realism and expressiveness of each of this instrument's ten preset Voices.

- 1 While holding down the [▶/■] (Play/Stop) button, press one of the C0 – A0 keys to select the desired Demo Song.**

Playback of the selected Demo Song starts.

NOTE

For details on playback operations, refer to page 28.

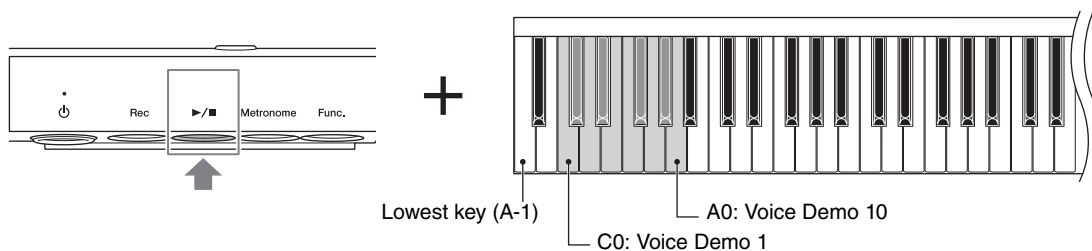

Demo Song List

Key	Demo Song No.	Voice Name	Song Name	Composer
C0	1	CFX Grand	Widmung S.566 R.253	F. Liszt / R. Schumann
C#0	2	Bösendorfer Imperial	Mädchens Wunsch (6 Chants polonaise S.480 R.145)	F. Liszt / F. F. Chopin
D0	3	Upright Piano	Italienisches Konzert, BWV 971 1st mov.	J. S. Bach
D#0	4	Stage E.Piano	Original	—
E0	5	DX E.Piano	Original	—
F0	6	Vintage E.Piano	Original	—
F#0	7	Harpsichord 8'	Concerto a cembalo obbligato, 2 violini, viola e continuo No.7, BWV 1058	J. S. Bach
G0	8	Celesta	Danse de la Fée Dragée	P. I. Tchaikovsky
G#0	9	Organ Principal	Herr Christ, der ein'ge Gottes-Sohn, BWV 601	J. S. Bach
A0	10	Jazz Organ	Original	—

- 2 Press the [▶/■] (Play/Stop) button to stop playback.**

When the end of the Song is reached, playback stops automatically.

Playing back the Preset Songs

This instrument features a collection of built-in preset Songs—“50 Classical Music Masterpieces”—for playback.

- 1 While holding down the [▶/■] (Play/Stop) button, press one of the C2 – C#6 keys to select the desired preset Song.

Playback of the selected preset Song starts. For details on the key assignments of the preset Songs, refer to the “Song List” (page 43).

NOTE

For details on playback operations, refer to page 28.

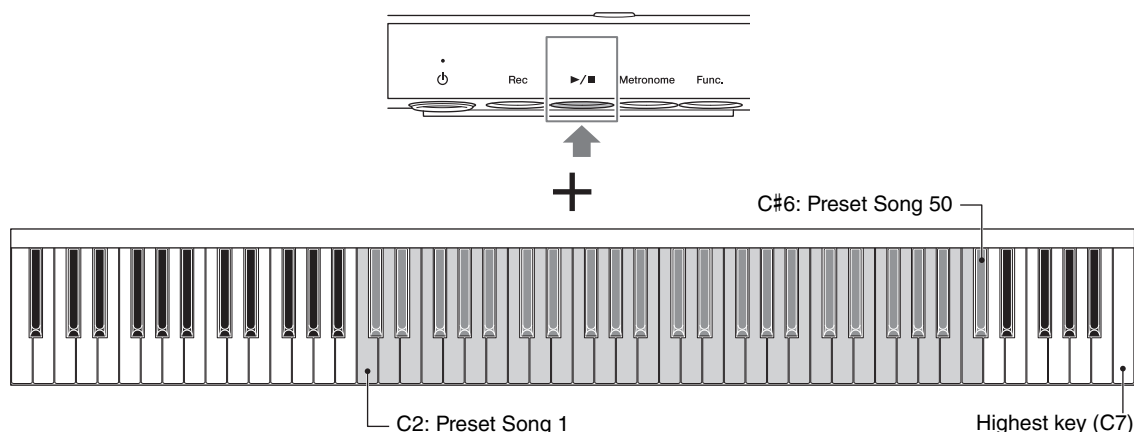

- 2 Press the [▶/■] (Play/Stop) button to stop playback.

When the end of the Song is reached, playback stops automatically.

■ Playing back continuously

All preset Songs can be played back continuously in number order or in random order. While holding down the [▶/■] (Play/Stop) button, press the F6 or F#6 key to start playback.

- **Playback in number order (F6):** Continuously plays back from the Song number 1 in order. When all 50 Songs are played back, playback starts from the first again.
- **Playback in random order (F#6):** Continuously plays back all Songs in random order. When all 50 Songs are played back, the Random Playback starts again.

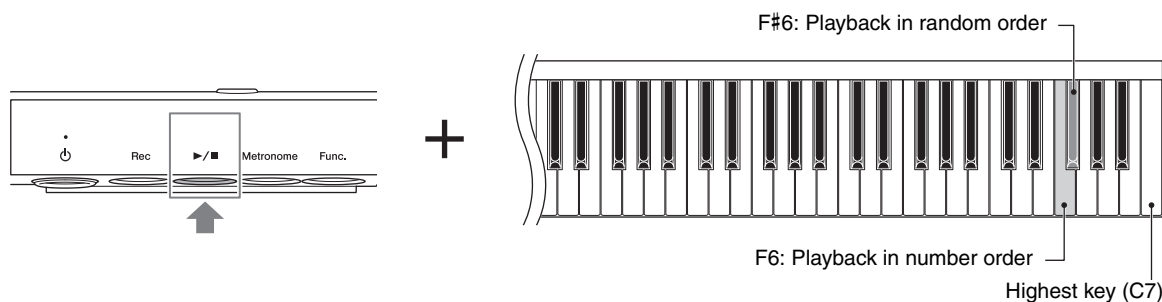

Operations during playback

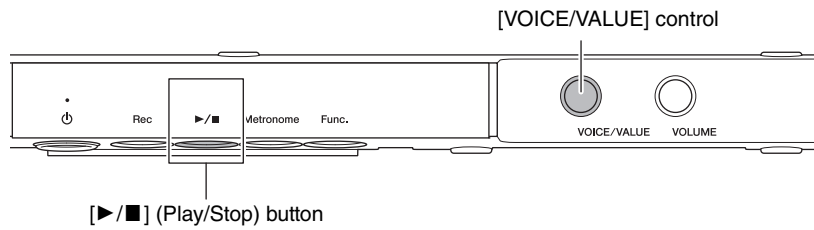

Stop

Press the [▶/■] (Play/Stop) button to stop playback. When the Song is played back next time, it starts from the beginning.

Rewind/Fast forward

While holding down the [▶/■] (Play/Stop) button, rotate the [VOICE/VALUE] control. Rotate the control to the left to rewind, rotate it to the right to fast forward.

MIDI Songs and preset Songs are moved one measure back or forward, while Audio Songs are moved one second.

During rewinding/fast forwarding

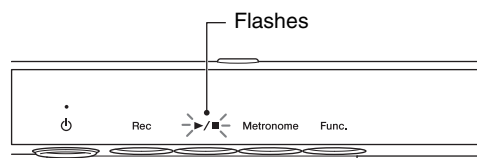

NOTE

Rewind and fast forward operations are not available for Demo Songs.

Adjusting the playback tempo

You can change the tempo or speed during Song playback.

MIDI Songs (including Voice Demo Songs and Preset Songs)

The MIDI Song tempo can be adjusted in the same operation as the metronome tempo. Refer to “Adjusting the tempo” (page 20).

NOTE

- When the MIDI Song tempo is changed, the metronome tempo is also changed to the same tempo.
- For MIDI Songs having tempo changes in the middle of the Song, changing the tempo alters entire tempo relatively. For example, in a Song that is set to a tempo of 100 at the start and changes midway during the Song to 120, changing the starting tempo to 110 (10% faster) will result in a midway tempo of 132 (10% faster).

Audio Songs

The playback speed of an Audio Song in the USB flash drive can be adjusted by stretching or compressing it. Compared to an original speed of 100%, it can be adjusted over the range of 75% – 125%.

During playback, while holding down the [Metronome] button, rotate the [VOICE/VALUE] control to adjust the playback speed.

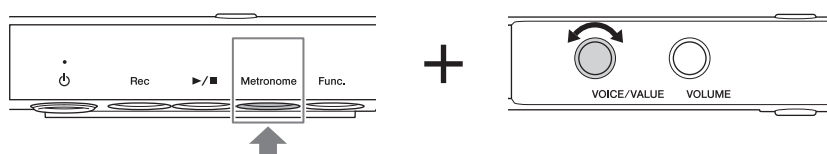

Pressing the [VOICE/VALUE] control while holding down the [Metronome] button lets you reset to the original speed.

Pressing one of the A#0 – D1 keys while holding down the [Metronome] button lets you increase/decrease the speed by 1% or 10%.

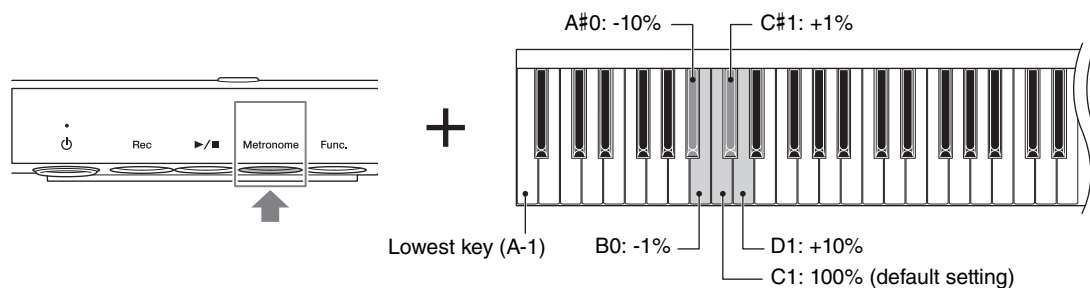

NOTE

The Audio Song speed does not affect the metronome tempo.

Connecting to Other Devices

⚠ CAUTION

Before connecting the instrument to other electronic components, turn off the power to all the components. Also, before turning any components on or off, set all volume levels to minimum (0). Otherwise, damage to the components, electrical shock, or even permanent hearing loss may occur.

Connecting to external audio devices ([AUX IN] jack)

By connecting the [AUX IN] jack to other sound modules or playback devices (such as portable music players), you can use the Silent Piano™ function together with the sound received from the connected devices.

NOTE

Use audio cables and adaptor plugs having no (zero) resistance.

■ Example of using the [AUX IN] jack

You can use the [VOLUME] control on this unit to simultaneously adjust the volume of its electronic sound and the sound received through its [AUX IN] jack. To set a proper balance of the levels, adjust the output volume on the connected device.

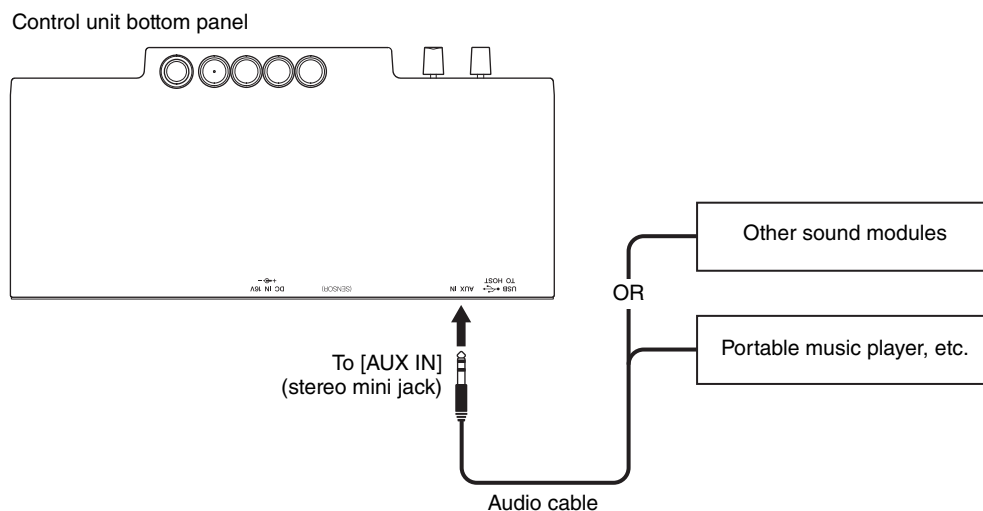

NOTE

By default, this instrument uses a convenient Noise Gate effect to cut unwanted noise from the sound input via the [AUX IN] jack. However, this may result in necessary sounds also being cut, such as the soft decay sound of a piano. To avoid this, set the Noise Gate to off (page 38).

Connecting to a computer/smart device

Connecting this instrument to a computer or a smart device expands the possibility.

What you can do by connecting to a computer/smart device:

- Transmitting and receiving audio data (USB Audio Interface function, page 32)
- Using a smart device app (page 32)
- Transmitting and receiving MIDI data
- Saving the Song recorded on this instrument to the computer

NOTE

For details on transmitting/receiving MIDI data or saving the Song to a computer, refer to the “Computer-related Operations” on the website.

Connection example

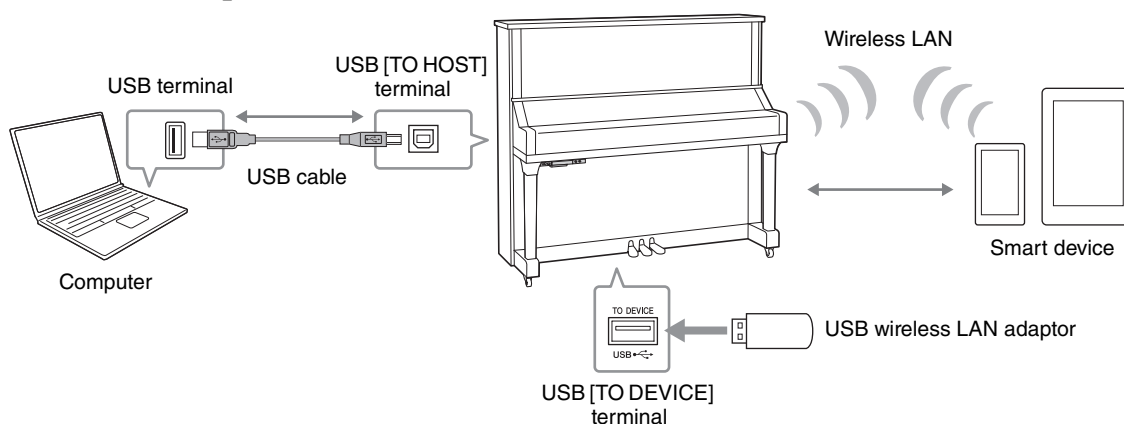

If you are using the “Smart Pianist” app on a smart device, the app makes it easier to connect this instrument to the smart device (page 11).

For instructions on other connection methods, refer to the “Computer-related Operations” or the “iPhone/iPad Connection Manual” on the website (page 10).

NOTICE

- Do not connect this product to public Wi-Fi and/or Internet directly. Only connect this product to the Internet through a router with strong password-protections. Consult your router manufacturer for information on security best practices.
- Use an AB type USB cable of less than 3 meters. USB 3.0 cables cannot be used.
- If you are using a DAW (digital audio workstation) application with this instrument, set the Audio Loop Back (page 39) to off. Otherwise, a loud sound may occur, depending on the settings of the computer or the application software.
- Do not place your computer or smart device in an unstable position. Doing so may cause the device to fall and result in damage.

NOTE

- When using a USB cable to connect the instrument to your computer or smart device, make the connection directly without passing through a USB hub.
- For information on setting up your sequence software, refer to the owner’s manual of the relevant software.
- When transmitting or receiving audio signals by using the computer operated by Windows, the Yamaha Steinberg USB Driver should be installed to the computer. For details, refer to the “Computer-related Operations” on the website.
- Before using the USB [TO DEVICE] terminal, be sure to read “Precautions when using the USB [TO DEVICE] terminal” on page 25.
- When you use the instrument along with an application on your smart device, we recommend that you set your device to not emit radio waves (for example, by setting “Airplane Mode” to on).
- The instrument will begin transmission a short time after the computer or smart device is connected.

■ Transmitting/receiving audio data (USB Audio Interface function)

By connecting a computer or a smart device to the USB [TO HOST] terminal via a USB cable, digital audio data can be transmitted/received, giving you the following advantages:

- **Playing back audio data with high sound quality**

This gives you direct, clear sound in which the sound quality has less noise and deterioration than that from the [AUX IN] jack.

- **Recording performance on the instrument as audio data by using a recording software or a music production software**

The recorded audio data can be played back on the computer or smart device.

NOTE

- The volume of the audio sound input can be adjusted from a computer or smart device.
- You can set whether audio sound input from the connected computer or smart device is output to a computer or a smart device or not, along with the performance played on the instrument. For details, refer to “Audio Loop Back” on page 39.

■ Using a smart device app

By using the compatible smart device app, you can take advantage of convenient functions and get more enjoyment out of this instrument. Especially, “Smart Pianist” (page 11) enables you to conveniently control the various functions of this instrument from the smart device. For information about the compatible apps and smart devices, access the web page of the respective apps on the following page:

<http://www.yamaha.com/kbdapps/>

This section explains how to connect a smart device by using the separately sold USB wireless LAN adaptor UD-WL01. For connections with other methods, refer to the “iPhone/iPad Connection Manual” on the website.

NOTE

If you are using the “Smart Pianist” app, you can connect this instrument to your smart device by the connection wizard in “Smart Pianist” (page 11).

Connection with the USB wireless LAN adaptor (UD-WL01*)

*UD-WL01 (sold separately) may not be available depending on your area.

There are two types of connections with the USB wireless LAN adaptor (UD-WL01) described below.

- **Connecting by the Access Point mode**

You can use this mode when there is not any access point available for connection to the instrument, or when it is unnecessary to connect to another network while a smart device is connected to the instrument.

The Access Point mode allows you to directly connect the USB wireless LAN adaptor and a smart device, without the need for using an access point.

Access point

An “access point” refers to a device which acts as a base station when data is transmitted/received via a USB wireless LAN adaptor. Some access points are combined with router or modem functions.

1 Initialize the instrument (if necessary; see page 40).

2 Connect the UD-WL01 to the USB [TO DEVICE] terminal.

3 Connect a smart device to the instrument (as an access point).

NOTE

When you change the Infrastructure mode (see the right column) to the Access Point mode, initialize the instrument.

- **Connecting by the Infrastructure mode (automatic setup by WPS)**

You can use this mode when you connect to another network while a smart device is connected to the instrument.

The Infrastructure mode uses an access point for data communication between a USB wireless LAN adaptor and a network.

1 Connect the UD-WL01 to the USB [TO DEVICE] terminal.

2 Hold down the WPS button on the UD-WL01 for three seconds.

3 Press the WPS button on your access point within two minutes after step 2.

NOTE

Once you connect by the Infrastructure mode, you can connect to a network automatically without executing steps 2 and 3.

Using Other Functions

Setting the various convenient functions

To get the most out of your piano, set some of the various convenient functions, such as fine tuning of the pitch, adjusting the touch sensitivity, etc.

Function List

Function		Page
Operation Sound On/Off		page 34
Keyboard	Touch Sensitivity	page 34
	Master Tune	page 34
	Transpose	page 35
Half Pedal Point		page 35
Sound	Reverb Type	page 36
	Reverb Depth	page 36
	Brilliance	page 37
	Binaural On/Off	page 37
	VRM On/Off	page 37
MIDI	Local Control	page 38
Auto Power Off		page 38
AUX IN Noise Gate		page 38
Version		page 39
Audio Loop Back		page 39

To set these functions, simultaneously hold down the [Func.] button and press the appropriate key or button. In this section, the example operation steps below apply to all relevant functions.

Example:

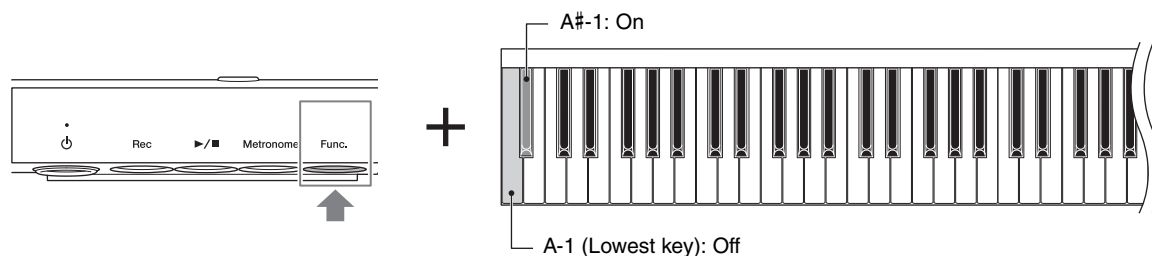

This means “While holding down the [Func.] button, press the A-1 or A#1 key.”

■ Operation Sound On/Off

Turns on or off the operation confirmation sound (click, “On,” “Off”) which sounds when a setup is changed using a button and key combination.

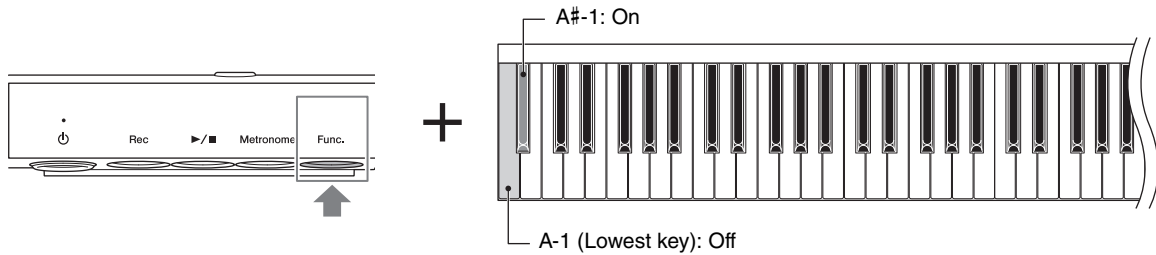

Default setting: On

NOTE

The metronome tempo value is read out (page 19) even when the operation sound is turned off.

■ Touch Sensitivity

Determines how the sound responds to your playing strength.

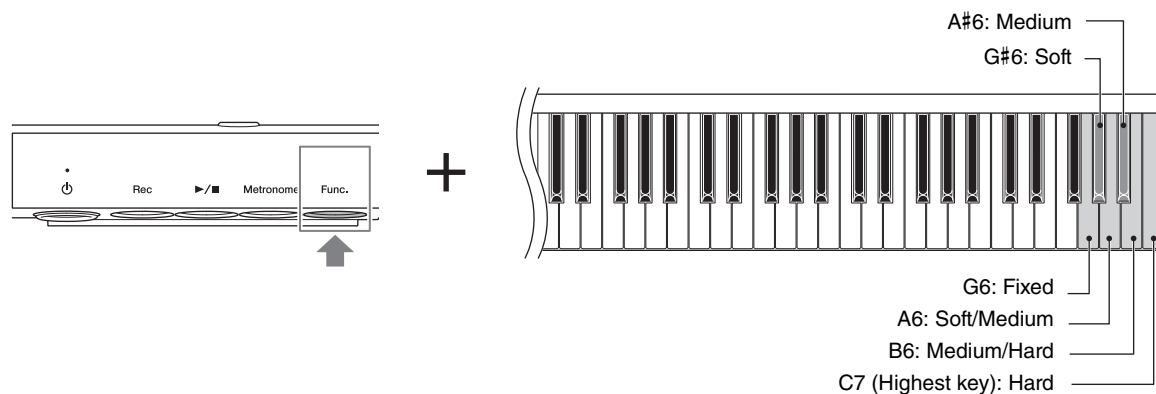

- **Fixed:** No touch response. The volume level will be the same regardless of how hard you play the keys.
- **Soft:** Produces relatively high volume even with light playing strength.
- **Soft/Medium:** Produces high volume with moderate playing strength.
- **Medium:** Standard Touch Sensitivity.
- **Medium/Hard:** Requires moderately strong playing for high volume.
- **Hard:** Requires strong playing to produce high volume.

Default setting: Medium

■ Master Tune

Fine tunes the pitch of the entire instrument. This lets you accurately match the keyboard pitch to that of other instruments or music on a portable music player.

To raise the pitch:

While holding down the [Func.] button, press the [▶/■] (Play/Stop) button.

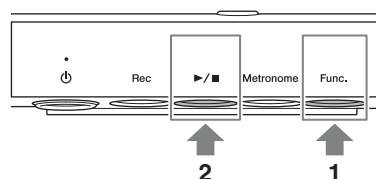

To lower the pitch:

While holding down the [Func.] button, press the [Rec] button.

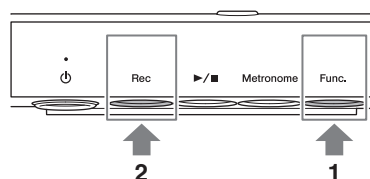

To restore default pitch:

While holding down the [Func.] button, press the [Rec] and [▶/■] (Play/Stop) buttons simultaneously.

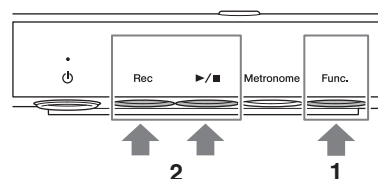

Setting range: A3 = 414.8 Hz – 466.8 Hz (approx. 0.2 Hz steps)

Default setting: A3 = 440.0 Hz

NOTE

The pitch of an Audio Song is not affected by this setting. The pitch of a MIDI Song is changed, but the setting cannot be recorded.

■ Transpose

Shifts the pitch of the entire keyboard up or down in semitone intervals to facilitate playing in difficult key signatures, and to let you easily match the pitch of the keyboard to the range of a singer or other instruments. For example, if you set this parameter to “5,” playing key C produces pitch F. In this way, you can play the F major song as if it were in C major.

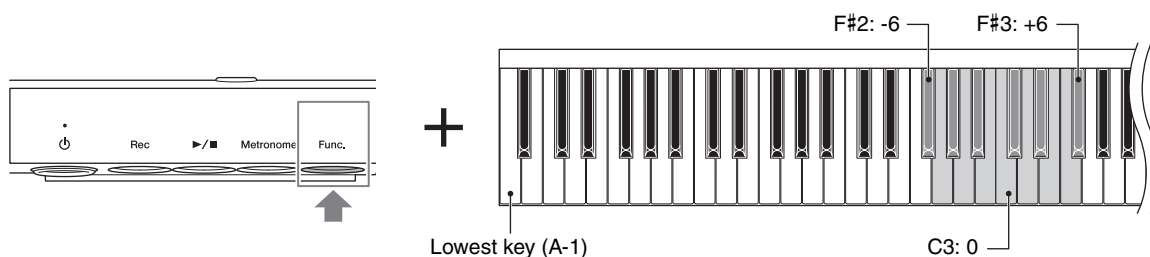

Setting range: -6 – 0 – +6 (in semitone steps)

Default setting: 0

NOTE

- The sound input from the external device and the recorded Songs cannot be transposed.
- Your keyboard performance data will be transmitted with the transposed note numbers while MIDI note numbers received from an external MIDI device or computer will not be affected by the Transpose setting.

■ Half Pedal Point

You can set the degree to which pressing the damper pedal applies the half-pedal effect. The larger the value, the wider the half-pedal range. Larger values give you greater leeway in controlling the half-pedal effect.

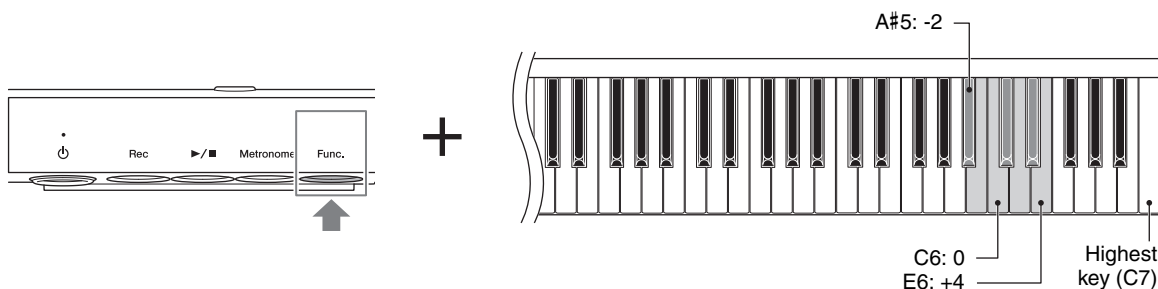

Setting range: -2 – 0 – +4

Default setting: 0

Half-pedal function

This function allows the sustain length to vary depending on how far the pedal is pressed. The farther you press the pedal, the more the sound sustains. For example, if you press the damper pedal and all notes you are playing sound a bit murky and loud with too much sustain, you can release the pedal half way to subdue the sustain (murkiness).

■ Reverb Type

An actual piano sounds differently depending on the size of the room, or the material of the building in which it is played. The reverberation is the major reason for this difference. Using the Reverb effect and simulating the reverberation in a concert hall, etc. gives you the feeling of the being at a live performance. Although selecting a Voice will call up the optimum Reverb type for the selected Voice, you can change the Reverb type as desired.

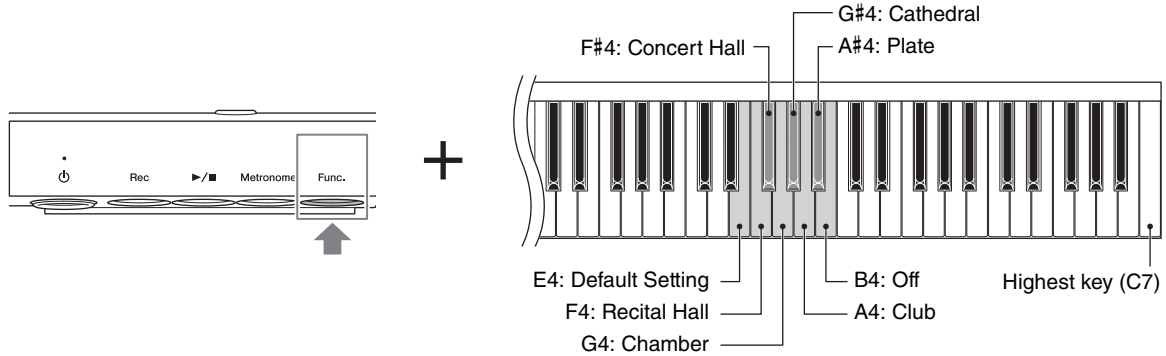

Reverb Type List

Reverb Type	Description
Default Setting	Resets the setting to the default.
Recital Hall	Simulates clear reverberation in a mid-sized hall suitable for piano recital.
Concert Hall	Simulates brilliant reverberation in a large hall for public orchestra performances.
Chamber	Simulates the elegant reverberation in a small room suitable for chamber music.
Cathedral	Simulates the solemn reverberation in a high-ceiling stone-made cathedral.
Club	Simulates the lively reverberation in a jazz club or a small bar.
Plate	Simulates the bright sound of vintage reverb equipment used in recording studios.
Off	No effect is applied.

NOTE

Reverb Type is reset to the default value automatically when the power is turned off.

■ Reverb Depth

Although selecting a Voice will call up the optimum Reverb depth for the selected Voice, you can change the Reverb depth as desired.

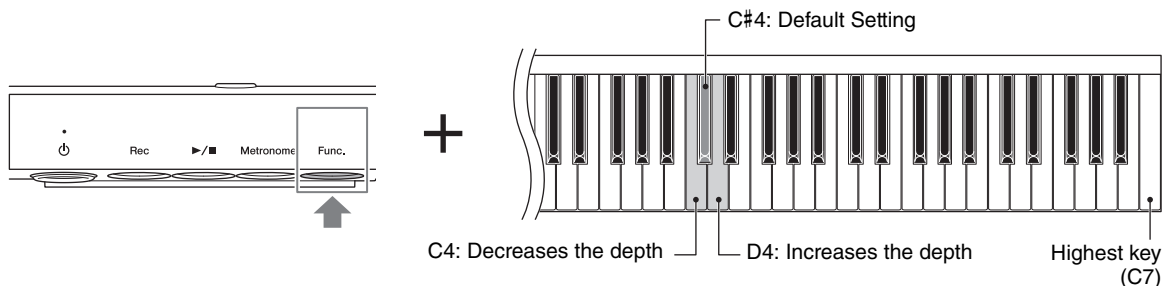

Setting range: 1 – 20

NOTE

Reverb Depth is reset to the default value automatically when the power is turned off.

■ Brilliance

Adjusts the timbre brilliance of the entire keyboard sound from mellow to bright.

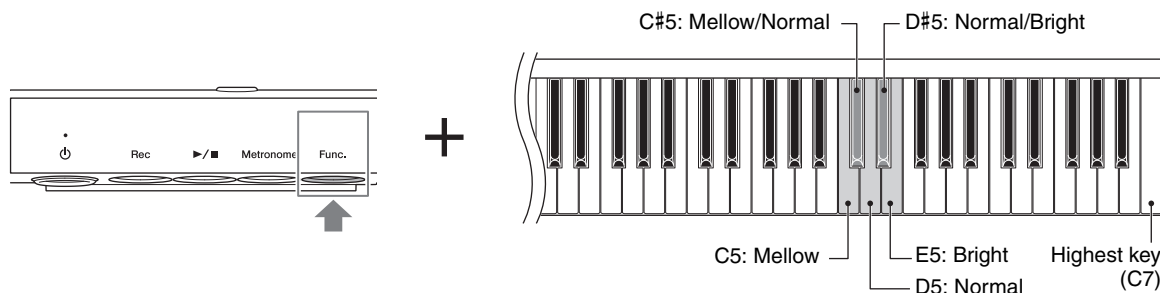

Default setting: Normal

■ Binaural On/Off

When this function is on, the sound from this instrument changes to the sound of Binaural Sampling or the sound enhanced with the Stereophonic Optimizer (page 18), allowing you to enjoy more realistic sound even when listening with headphones.

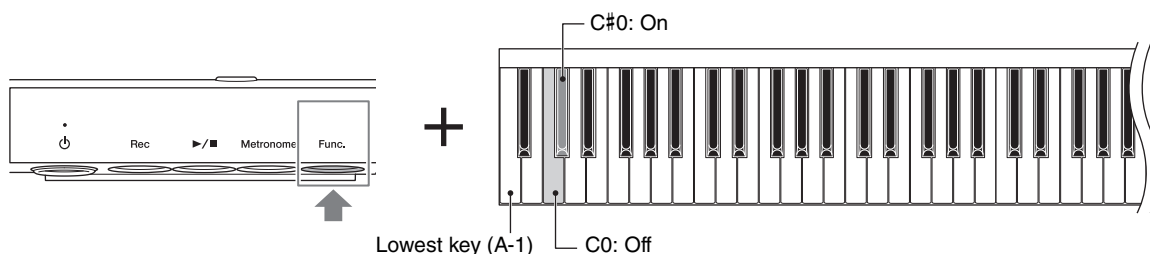

Default setting: On

Since the sound of Binaural Sampling and the sound enhanced with the Stereophonic Optimizer are optimized for listening with headphones, we recommend that you turn these functions off when listening to keyboard performance on this instrument or recorded Audio Song with an external audio device such as a powered speaker. (If you want to play the Audio Song recorded on this instrument through speakers, make sure to turn these functions off before using Audio Recording.)

■ VRM On/Off

Turns the VRM effect (see below) on/off. For information on which Voices have the VRM effect applied, refer to "Selecting Voices" on page 17.

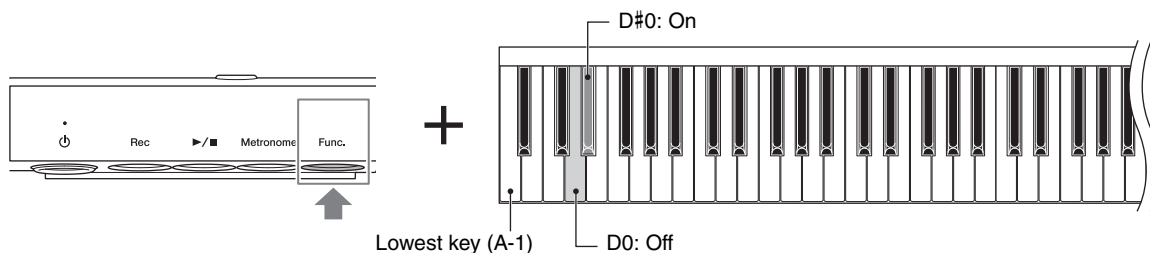

Default setting: On

VRM (Virtual Resonance Modeling) technology

On an actual acoustic piano, if you press the damper pedal and play a key, not only does the string of the pressed key vibrate, it also causes other strings and the soundboard to vibrate, with each influencing the rest, creating a rich and brilliant resonance that sustains and spreads. The VRM (Virtual Resonance Modeling) technology featured in this unit reproduces the complicated interaction of both string and soundboard resonance faithfully using a virtual musical instrument (physical modeling), and makes the sound more like a real acoustic piano. Since instantaneous resonance is made at the moment according to the state of the keyboard or pedal, you can vary the sound expressively by changing the timing of your pressing the keys, and the timing and depth of your pressing the pedal.

■ Local Control

Turns the Local Control function on/off. “Local Control On” is a state in which this instrument produces the sound from its tone generator when you play the keyboard. In “Local Control Off” state, the keyboard and the tone generator are cut off from each other. This means that even if you play the keyboard, this instrument will produce no sound. Instead, the keyboard data can be transmitted via MIDI to a connected device such as computer, which can produce the sound. The “Local Control Off” setting is useful when you wish to play only an external sound source while playing the keys on this instrument.

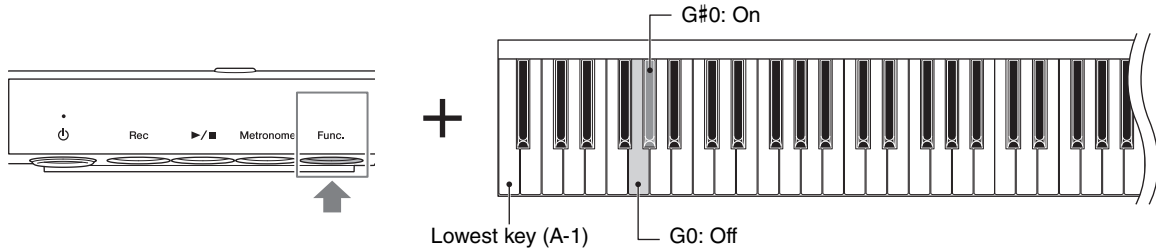

Default setting: On

■ Auto Power Off

Turns the Auto Power Off function (page 15) on/off. If you do not want the power to be turned off automatically, set this function to off.

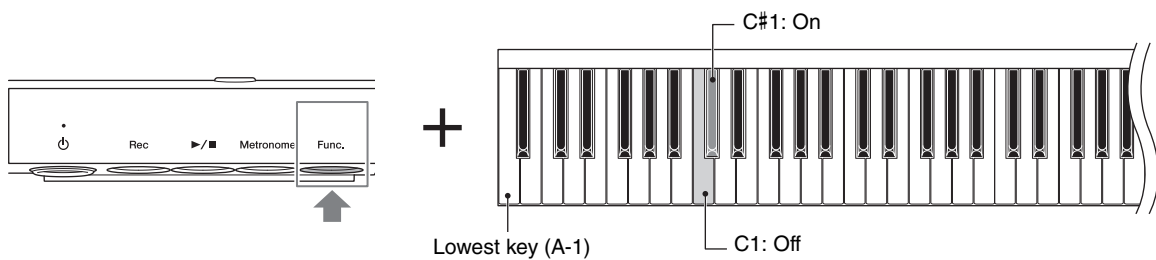

Default setting: On

■ AUX IN Noise Gate

The AUX IN Noise Gate function conveniently cuts unwanted noise from the sound input via the [AUX IN] jack. However, this may result in necessary sounds also being cut, such as the soft decay sound of a piano. To avoid this, set this function to off.

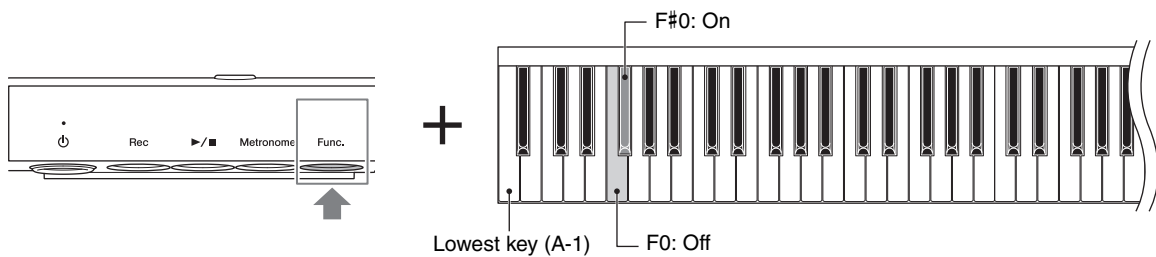

Default setting: On

■ Version

The firmware version of this unit is read out in English.

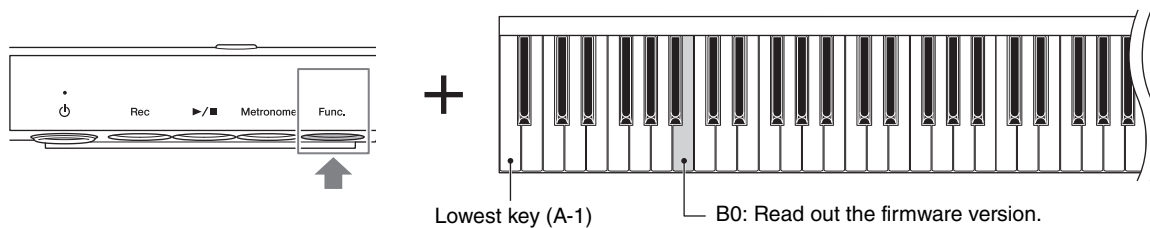

■ Audio Loop Back

Determines whether audio sound input from the connected computer or smart device (via the USB Audio Interface function or wireless connection; page 31) is output to a computer or a smart device or not, along with the performance played on the instrument. To output the audio input sound, set Audio Loop Back to “On.”

For example, if you want to record the audio input sound as well as the sound played on the instrument to a computer or smart device, set this to “On.” If you intend to record only the sound played on the instrument to a computer or smart device, set this to “Off.”

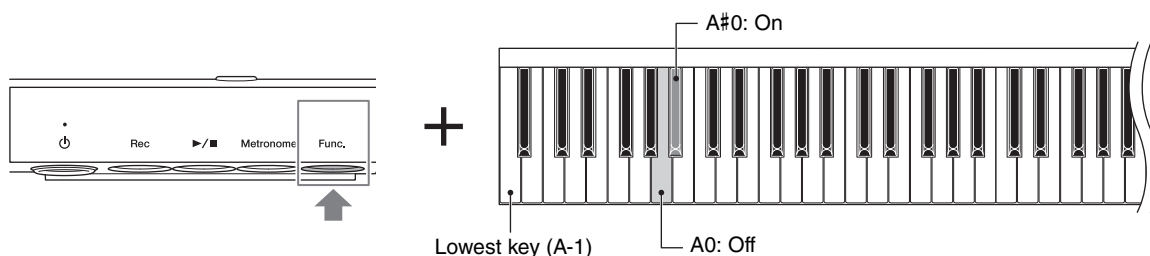

Default setting: On

NOTICE

If you are using a DAW (digital audio workstation) application with this instrument, set the Audio Loop Back function to off. Otherwise, a loud sound may occur, depending on the settings of the computer or the application software.

NOTE

- The playback sound of an Audio Song on this instrument is also output to a computer or smart device when this is set to “On,” while the sound is not output when this is set to “Off.”
- With Audio Recording on this instrument, the audio input sound from the connected computer or smart device is recorded when this is set to “On,” while the sound is not recorded when this is set to “Off.”

Backup data and initialization

■ Backup data

The following settings, referred to as Backup data, are automatically saved to the internal memory of this unit. The Backup data and the MIDI Song recorded to the internal memory will be maintained even if the power is turned off.

- Brilliance..... page 37
- Touch Sensitivity page 34
- Master Tune page 34
- Metronome Volume page 21
- Half Pedal Point..... page 35
- Binaural on/off..... page 37
- Auto Power Off on/off..... page 38
- AUX IN Noise Gate on/off..... page 38
- Audio Loop Back on/off..... page 39

■ Initializing the instrument

While holding down the C7 key, turn on the power by pressing the [⏻] (Standby/On) switch. This operation will initialize the Backup data. The MIDI Song recorded to the internal memory will not be erased.

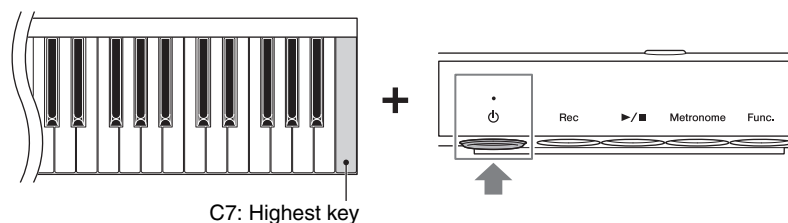

The [▶/■] (Play/Stop) lamp flashes three times, and then all lamps will light as the data is cleared.

While Initializing

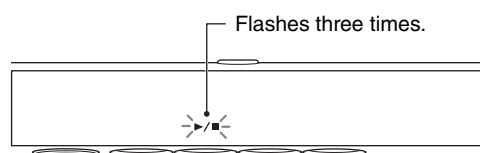

NOTICE

While the [▶/■] (Play/Stop) lamp flashing (i.e., data is being initialized), never turn off the power. Doing so may delete the MIDI Song recorded to the instrument, or corrupt the Backup data.

NOTE

If this instrument somehow becomes disabled or malfunctions, turn off the power to the instrument, then perform the initialization procedure.

Troubleshooting

If you have problems with your Silent Piano™, here are a few troubleshooting tips. If you cannot solve the problem easily yourself, consult your Yamaha piano dealer. DO NOT attempt to repair the piano or the AC adaptor yourself.

The unit is turned on but does not emit sound.

- The AC adaptor may not be plugged in correctly. Insert the AC adaptor firmly into the DC IN 16V jack and AC outlet.
- The [VOLUME] control may be turned to the far left position. Adjust the setting to an optimal level. The unit outputs standard volume when the volume control is set to the 3 o'clock position.

The power is automatically turned off.

- This is normal and due to the Auto Power Off function. If necessary, disable the Auto Power Off function (page 15).

The acoustic piano emits sound when I am playing with the Silent Piano™ function active.

- Playing with extreme force may result in sound being emitted from the acoustic piano. Please moderate the strength of your playing.

The balance varies when listening through commercially available headphones.

- Headphone properties differ depending on their type, so different headphones may have different balance characteristics.

The volume varies when listening through commercially available headphones.

- Headphone properties differ depending on their type, so different headphones may have different volume characteristics.

I can hear a rattling sound from the piano body when using it in Silent Piano™ mode.

- This is not a fault. This is the sound of the acoustic piano's keystroke.

When I play a rapid series of notes in Silent Piano™ mode, a loud sound is emitted that is not part of the performance.

- This is not a fault. The structure of the Silent Piano™ causes this to occur in some cases.

No Reverb effect is applied to the sound.

- The Reverb depth may be set to minimum. Adjust the depth to apply an appropriate amount of Reverb (page 36).

The sound lingers excessively.

- The Reverb depth may be set to an excessive level. Adjust the Reverb depth to an appropriate level (page 36).

The pitch of this instrument is different from that of other instruments.

- You can adjust the pitch of this unit to match that of other instruments (page 34).

The connected USB flash drive does not respond.

- Disconnect the USB flash drive from the unit and then connect it again. If it still does not respond, it may be damaged.
- Check if your USB flash drive is supported on this unit (page 25).

The Song saved in the USB flash drive cannot be played back.

- This unit can play only the latest recorded Song in the USB flash drive. If you want to play the Songs recorded previously, use an external audio device such as a computer or a portable music player.

Sound input to the [AUX IN] jack is interrupted.

- The Noise Gate function is activated (page 38). Increase the output volume of the external device connected to the [AUX IN] jack, or set the Noise Gate to off.

(Grand Piano) No Sostenuto effect is applied when the sostenuto pedal is pressed.

- The Sostenuto effect cannot be applied when the Silent Piano function is active.

Specifications

			Upright Piano	Grand Piano
Control Interface	Keyboard	Touch Response	Hard, Medium/Hard, Medium, Soft/Medium, Soft, Fixed	
	Pedal		Damper, Silencing/Sostenuto*, Soft *For models equipped with a sostenuto pedal	Damper, Sostenuto/Bass sustain (no effect for Silent Piano function), Soft
	Sensor System	Keys	Non-contact continuous detection optical sensor	
		Damper Pedal	Continuous detection sensor	
Soft Pedal		On/Off detection sensor		
Silencing System	Mechanism		Hammer shank stopper operated by silencing pedal	Hammer shank stopper operated by silencing lever
	Action		–	Quick Escape mechanism
Voices	Tone Generation	Piano Sound	Yamaha CFX, Bösendorfer Imperial	
		Binaural Sampling	Yes (CFX Grand Voice only)	
	Piano Effect	VRM	Yes	
		Key-off Samples	Yes	
		Smooth Release	Yes	
	Polyphony (max.)		256	
Preset	Number of Voices	10		
Effects	Types	Reverb	Yes	
		Brilliance	Yes	
		Stereophonic Optimizer	Yes	
Songs (MIDI)	Preset	Number of Preset Songs	10 Voice Demo Songs, 50 Classics	
	Recording	Number of Songs	1	
		Data Capacity	approx. 500 KB	
	Format	Recording	SMF (Format 0)	
Recording/ Playback (Audio)	Recording Time (max.)		80 minutes/Song	
	Format	Playback	WAV (44.1 kHz, 16 bit, stereo)	
		Recording	WAV (44.1 kHz, 16 bit, stereo)	
Functions	Overall Controls	Metronome	Yes	
		Tempo Range	5 – 500	
		Transpose	-6 – 0 – +6	
		Tuning	414.8 – 440.0 – 466.8 Hz (approx. 0.2 Hz increments)	
	USB audio interface		44.1 kHz, 16 bit, stereo	
Storage and Connectivity	Storage	Internal Memory	approx. 550 KB	
		External Drives	USB flash drive	
	Connectivity	DC IN	16 V	
		Headphones	Stereo mini jack (x2)	
		AUX IN	Stereo mini jack	
		USB TO DEVICE	Yes	
USB TO HOST	Yes			
Power Supply	AC Adaptor		PA-300C (or an equivalent recommended by Yamaha)	
	Power Consumption		11W (When using PA-300C AC adaptor)	
	Auto Power Off		Yes	
Weight (excluding the weight of the piano body)			4 kg (8 lb, 13 oz)	
Included Accessories			AC adaptor*, power cord*, headphones, headphone hanger, attachment screws for headphone hanger, Owner's Manual *May not be included depending on your area. Check with your Yamaha dealer.	
Separately Sold Accessories (May not be available depending on your area.)			USB wireless LAN adaptor (UD-WL01), wireless MIDI adaptor (UD-BT01)	

The contents of this manual apply to the latest specifications as of the publishing date. To obtain the latest manual, access the Yamaha website then download the manual file. Since specifications, equipment or separately sold accessories may not be the same in every locale, please check with your Yamaha dealer.

Song List

50 Classical Music Masterpieces

No.	Key	Song Title	Composer
Arrangements			
1	C2	Canon D dur	J. Pachelbel
2	C#2	Air On the G Strings	J. S. Bach
3	D2	Jesus, Joy of Man's Desiring	J. S. Bach
4	D#2	Twinkle, Twinkle, Little Star	Traditional
5	E2	Piano Sonate op.31-2 "Tempest" 3rd mov.	L. v. Beethoven
6	F2	Ode to Joy	L. v. Beethoven
7	F#2	Wiegenlied op.98-2	F. P. Schubert
8	G2	Grande Valse Brillante	F. F. Chopin
9	G#2	Polonaise op.53 "Héroïque"	F. F. Chopin
10	A2	La Campanella	F. Liszt
11	A#2	Salut d'amour op.12	E. Elgar
12	B2	From the New World	A. Dvořák
13	C3	Sicilienne	G. U. Fauré
14	C#3	Clair de lune	C. A. Debussy
15	D3	Jupiter (The Planets)	G. Holst
Duets			
16	D#3	Menuett (Eine kleine Nachtmusik K.525)	W. A. Mozart
17	E3	Menuett G dur	L. v. Beethoven
18	F3	Marcia alla Turca	L. v. Beethoven
19	F#3	Piano Concerto No.1 op.11 2nd mov.	F. F. Chopin
20	G3	The Nutcracker Medley	P. I. Tchaikovsky
Original Compositions			
21	G#3	Prelude (Wohltemperierte Klavier I No.1)	J. S. Bach
22	A3	Menuett G dur BWV.Anh.114	J. S. Bach
23	A#3	Piano Sonate No.15 K.545 1st mov.	W. A. Mozart
24	B3	Turkish March	W. A. Mozart
25	C4	Piano Sonate op.13 "Pathétique" 2nd mov.	L. v. Beethoven
26	C#4	Für Elise	L. v. Beethoven
27	D4	Piano Sonate op.27-2 "Mondschein" 1st mov.	L. v. Beethoven
28	D#4	Impromptu op.90-2	F. P. Schubert
29	E4	Frühlingslied op.62-6	J. L. F. Mendelssohn
30	F4	Fantaisie-Impromptu	F. F. Chopin
31	F#4	Etude op.10-3 "Chanson de l'adieu"	F. F. Chopin
32	G4	Etude op.10-12 "Revolutionary"	F. F. Chopin
33	G#4	Valse op.64-1 "Petit chien"	F. F. Chopin
34	A4	Nocturne op.9-2	F. F. Chopin
35	A#4	Nocturne KK4a-16/BI 49 [Posth.]	F. F. Chopin
36	B4	Träumerei	R. Schumann
37	C5	Barcarolle	P. I. Tchaikovsky
38	C#5	La prière d'une Vierge	T. Badarzewska
39	D5	Liebesträume No.3	F. Liszt
40	D#5	Blumenlied	G. Lange
41	E5	Humoresque	A. Dvořák
42	F5	Arietta	E. H. Grieg
43	F#5	Tango (España)	I. Albéniz
44	G5	The Entertainer	S. Joplin
45	G#5	Maple Leaf Rag	S. Joplin
46	A5	La Fille aux Cheveux de Lin	C. A. Debussy
47	A#5	Arabesque No.1	C. A. Debussy
48	B5	Cakewalk	C. A. Debussy
49	C6	Je te veux	E. Satie
50	C#6	Gymnopédies No.1	E. Satie

Index

A

Access Point mode	32
Accessories	10
Audio Loop Back	39
Audio recording	22, 24
Audio Song	24
Auto Power Off	15, 38
AUX IN	30
AUX IN Noise Gate	38

B

Backup data	40
Beat (metronome)	19
Binaural	18, 37
Brilliance	37

C

Continuous playback	27
Control unit	13

D

Demo Song	26
Demo Song List	26

E

External speaker	15
------------------------	----

F

Fast forward	28
Format (instrument)	40
Format (USB flash drive)	25
Function	33

H

Half-pedal function	35
Headphone hanger	15
Headphones	15

I

Included Accessories	10
Infrastructure mode	32
Initialize	40
iPhone/iPad Connection Manual	10

L

Local Control (MIDI)	38
----------------------------	----

M

Master Tune	34
Metronome	19
MIDI recording	22
MIDI Song	23

N

Noise Gate (AUX IN)	38
---------------------------	----

O

Operation sound	34
-----------------------	----

P

Pedal	12
Playback	23, 24, 26, 27
Power	14
Preset Song	27

Q

Quick Operation Guide	44
-----------------------------	----

R

Recording	22, 24
Reverb	36
Rewind	28

S

Silent Piano function	16
Smart device	31
Smart Pianist	11
Song	22, 23, 24
Song List	43
Stereophonic Optimizer	18

T

Tempo (metronome)	20
Tempo (Song)	29
Time signature (metronome)	19
Touch Sensitivity (Touch Response)	34
Transpose	35
Troubleshooting	41
Tuning	34

U

USB Audio Interface	32
USB device	25
USB flash drive	25
USB [TO DEVICE]	25
USB [TO HOST]	31

V

Version	39
Voice	17
Voice Demo	26
Voice List	17
Volume (master volume)	16
Volume (metronome)	21
VRM (Virtual Resonance Modeling)	37

W

Wireless LAN	32
--------------------	----

MEMO



YAMAHA CORPORATION
10-1, Naka-ku, Hamamatsu, 430-8650 JAPAN

Manual Development Group
© 2018 Yamaha Corporation

Published 10/2019 MW-C0

YJ844C0