

# YAMAHA

# R-V302K

*Natural Sound AV Receiver*

自然音 AV 接收机

*Thank you for selecting this YAMAHA AV receiver.*

感谢阁下选用本 YAMAHA AV 接收机。

OWNER'S MANUAL

使用说明书

# CONTENTS

Supplied Accessories .....	2	Basic Operations .....	19
Features .....	3	Tuning Operations .....	22
Caution .....	4	Preset Tuning .....	23
Profile of This Unit .....	5	Using Digital Sound Field Processor (DSP) .....	26
Speaker Setup .....	6	Enjoying Karaoke .....	29
Connections .....	7	Setting the SLEEP Timer .....	32
Controls and Their Functions .....	12	Troubleshooting .....	33
Speaker Balance Adjustment .....	17	Specifications .....	34

## SUPPLIED ACCESSORIES

After unpacking, check that the following parts are included.

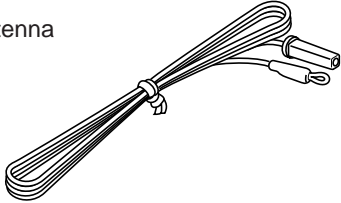
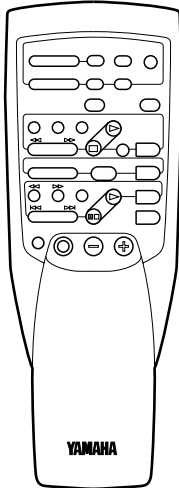
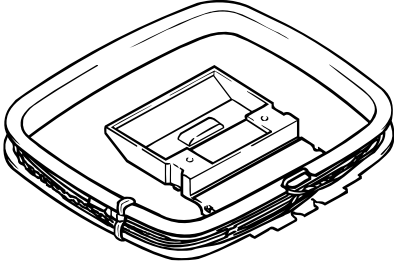
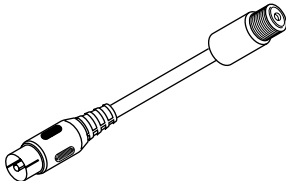
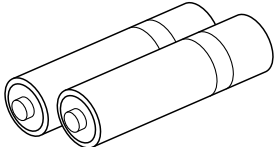
<p>Indoor FM Antenna</p> 	<p>Remote Control Transmitter</p> 
<p>AM Loop Antenna</p> 	
<p>Antenna adapter (U.S.A. model only)</p> 	
<p>Batteries (size AA, R6, UM-3)</p> 	

# FEATURES

## General

### ● 5 Speaker Configuration

#### <U.S.A. model>

Main: 60W + 60W (8Ω) RMS Output Power, 0.04% THD, 20–20,000 Hz

Center: 60W (8Ω) RMS Output Power, 0.1% THD, 1 kHz

Rear: 20W (8Ω) RMS Output Power, 0.7% THD, 1 kHz

#### <Singapore and General models>

Main: 55W + 55W (8Ω) RMS Output Power, 0.04% THD, 20–20,000 Hz

Center: 55W (8Ω) RMS Output Power, 0.1% THD, 1 kHz

Rear: 20W (8Ω) RMS Output Power, 0.7% THD, 1 kHz

- Video Signal Input/Output Capability
- SLEEP Timer
- Remote Control Capability

## Tuner

- 40-Station Random Access Preset Tuning
- Automatic Preset Tuning
- Preset Station Shifting Capability (Preset Editing)
- IF Count Direct PLL Synthesizer Tuning System

## Digital Sound Field Processor

- Digital Sound Field Processor (8 Programs including 4 programs for Karaoke)
- Dolby Surround Decoder ( □ PRO LOGIC, □ 3 STEREO)
- Automatic Input Balance Control for Dolby Surround
- Test Tone Generator for Easier Speaker Balance Adjustment
- Center Channel Output Mode Changing Capability

## Karaoke-functions

- 4 DSP Programs for Karaoke (BALLAD, POPS, JAZZ, ROCK)
- ONE TOUCH KARAOKE Button for Attenuating Vocals from a Music Source
- VOCAL AID Button to Assist You in Singing Karaoke
- 2 Microphone Connecting Capability
- MIC LEVEL and ECHO Level Controls
- Key Control Capability (in 13 steps)
- Karaoke Sound Recording Capability (Recording Your Singing Voice and Karaoke Effects with the Music Source)

# CAUTION : READ THIS BEFORE OPERATING YOUR UNIT.

1. To assure the finest performance, please read this manual carefully. Keep it in a safe place for future reference.
2. Install this unit in a cool, dry, clean place – away from windows, heat sources, sources of excessive vibration, dust, moisture and cold. Avoid sources of humming (transformers, motors). To prevent fire or electrical shock, do not expose the unit to rain or water.
3. Never open the cabinet. If something drops into the set, contact your dealer.
4. Do not use force on switches, controls or connection wires. When moving the unit, first disconnect the power plug and the wires connected to other equipment. Never pull the wires themselves.
5. The openings on the cabinet assure proper ventilation of the unit. If these openings are obstructed, the temperature inside the cabinet will rise rapidly. Therefore, avoid placing objects against these openings, and install the unit in well-ventilated condition. Make sure to allow a space of at least 20 cm behind, 20 cm on the both sides and 30 cm above the top panel of the unit. Otherwise it may not only damage the unit, but also cause fire.
6. Always set the VOLUME control to “– ∞” before starting the audio source play. Increase the volume gradually to an appropriate level after playback has been started.
7. Do not attempt to clean the unit with chemical solvents; this might damage the finish. Use a clean, dry cloth.
8. Be sure to read the “TROUBLESHOOTING” section regarding common operating errors before concluding that the unit is faulty.
9. When not planning to use this unit for long periods of time (ie., vacation, etc.), disconnect the AC power plug from the wall outlet.
10. To prevent lightning damage, disconnect the AC power plug and disconnect the antenna cable when there is an electrical storm.
11. Grounding or polarization – Precautions should be taken so that the grounding or polarization of an appliance is not defeated.
12. AC outlet  
Do not connect audio equipment to the AC outlet on the rear panel if that equipment requires more power than the outlet is rated to provide.
13. **Voltage Selector (General Model only)**  
The voltage selector on the rear panel of this unit must be set for your local main voltage **BEFORE** plugging into the AC main supply.  
Voltages are 110/120/220/240 V AC, 50/60 Hz.

## IMPORTANT

Please record the serial number of this unit in the space below.

Serial No.:

The serial number is located on the rear of the unit. Retain this Owner's Manual in a safe place for future reference.

## WARNING

**TO REDUCE THE RISK OF FIRE OR ELECTRIC SHOCK, DO NOT EXPOSE THIS UNIT TO RAIN OR MOISTURE.**

This unit is not disconnected from the AC power source as long as it is connected to the wall outlet, even if this unit itself is turned off.

In this state, this unit is designed to consume a very small quantity of power.

## FREQUENCY STEP switch (General Model only)

Because the interstation frequency spacing differs in different areas, set the FREQUENCY STEP switch (located at the rear) according to the frequency spacing in your area. Before setting this switch, disconnect the AC power plug of this unit from the AC outlet.

## WARNING

**Do not change the IMPEDANCE SELECTOR switch setting while the power to this unit is on, otherwise this unit may be damaged.**

## IF THIS UNIT FAILS TO TURN ON WHEN THE POWER SWITCH IS PRESSED

The **IMPEDANCE SELECTOR** switch may not be set to either end closely. If so, set the switch to either end closely.

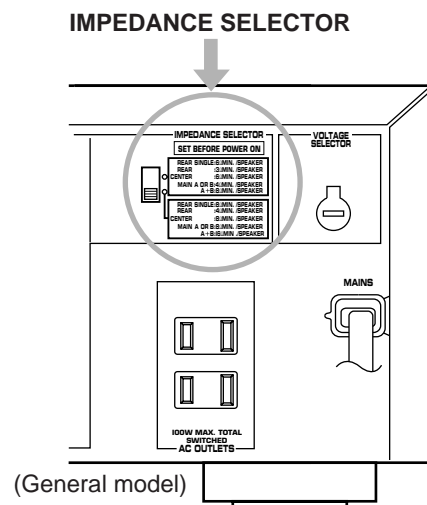

**This unit is designed for home use only. Do not use this unit for business purposes.**

## PROFILE OF THIS UNIT

You are the proud owner of a Yamaha AV receiver — an extremely sophisticated audio component. The Digital Sound Field Processor (DSP) built into this unit takes advantage of Yamaha's undisputed leadership in the field of digital audio processing to bring you a whole new world of listening experiences. Follow the instructions in this manual carefully when setting up your system, and this unit will sonically transform your room into a totally new listening environment. In addition, you get incredible realism from sources encoded with Dolby Surround using the built-in Dolby Pro Logic Surround Decoder.

This unit also has Karaoke functions. They are useful for enjoying Karaoke by using not only multisound sources for Karaoke, but also normal music sources with vocals. Furthermore, sound-surrounding effects of the DSP expand your Karaoke enjoyment, in which you will be absorbed in your singing.

Please read this operation manual carefully and store it in a safe place for later reference.

### Digital Sound Field Processing (DSP)

What is it that makes live music so good? Today's advanced sound reproduction technology lets you get extremely close to the sound of a live performance, but chances are you'll still notice something missing: the acoustic environment of the live concert hall. Extensive research into the exact nature of the sonic reflections that create the ambience of a large hall has made it possible for Yamaha engineers to develop their original Digital Sound Field Processing Technology to re-create the acoustic environment of a large concert hall in a home audio listening room.

Furthermore, our technicians, armed with sophisticated measuring equipment, have even made it possible to capture the acoustics of a variety of venues such as an actual concert hall, live house, etc. to re-create various types of actual live performance environments for home audio use.

The DSP programs on this unit are made on the basis of this technology.

### Dolby Pro Logic Surround

This unit employs a Dolby Pro Logic Surround decoder similar to professional Dolby Stereo decoders used in many movie theaters. By using the Dolby Pro Logic Surround decoder, you can experience the dramatic realism and impact of Dolby Surround movie theater sound in your own home. Dolby Pro Logic employs a four channel five speaker system. The Pro Logic Surround system divides the input signal into four levels: the left and right main channels, the center channel (used for dialog), and the rear surround sound channels (used for sound effects, background noise, and other ambient noises). The center channel allows listeners seated in even less-than-ideal positions to hear the dialog originating from the action on the screen while experiencing good stereo imaging.

Dolby Surround is encoded on the sound track of pre-recorded video tapes, laser discs, and some TV/cable broadcasts. When you play a source encoded with Dolby Surround on this unit, the Dolby Pro Logic Surround decoder decodes the signal and distributes the surround-sound effects.

This Dolby Pro Logic Surround Decoder employs a digital signal processing system. This system improves the stability of sound at each channel and minimizes crosstalk between channels, so that positioning of sounds around the room is more accurate compared with conventional analog signal processing systems.

In addition, this unit features a built-in automatic input balance control. This always assures you the best performance without manual adjustment.

Manufactured under license from Dolby Laboratories Licensing Corporation. "Dolby", the double-D symbol and "Pro Logic" are trademarks of Dolby Laboratories Licensing Corporation.

### Enjoying Karaoke with DSP

This unit is a new concept of AV receiver which has Karaoke functions. They are two microphone input jacks, microphone level control, echo level control, key level control and two sound output modes (ONE TOUCH KARAOKE and VOCAL AID) useful for singing Karaoke by using normal music sources with vocals.

In addition, the built-in digital sound field processor presents you with four programs which create sound fields suitable for singing Karaoke. In those sound fields, you will sing Karaoke with great feeling and sometimes excitedly.

# SPEAKER SETUP

## SPEAKERS TO BE USED

This unit is designed to provide the best sound-field quality with a 5 speaker configuration. The most effective speakers to use with this unit are main speakers, rear speakers and a center speaker. You can use one rear speaker only instead of using two rear speakers, and omit the center speaker. (Refer to the "SPEAKER CONFIGURATION" shown below.)

The main speakers are used for the main source sound plus the effect sounds. They will probably be the speakers from your present stereo system. The rear speakers are used for the effect and surround sounds, and the center speaker is for the center sounds (dialog etc.) within programs encoded with Dolby Surround. The center speaker needs to be equal in power to the main speakers, although the rear speakers should not be equal. However, all the speakers should have high enough power handling to accept the maximum output of this unit.

## SPEAKER CONFIGURATION

### 5-Speaker Configuration

This configuration is the most effective and recommended one. In this configuration, the center speaker is necessary as well as the rear speakers. If the program **DOLBY PRO LOGIC** or **DOLBY 3 STEREO** is selected, conversations will be output from the center speaker and the ambience will be excellent.

- Set the center channel mode to the "NORMAL" or "WIDE" position. (For details, refer to page 17.)

### 4-Speaker Configuration (without the center speaker)

The center speaker is not used in this configuration. If the program **DOLBY PRO LOGIC** is selected, the center sound is output from the left and the right main speakers. The program **DOLBY 3 STEREO** is useless in this configuration. However, the sound effect of other programs can be almost the same as that of the 5-speaker configuration.

- Be sure to set the center channel mode to the "PHANTOM" position. (For details, refer to page 17.)

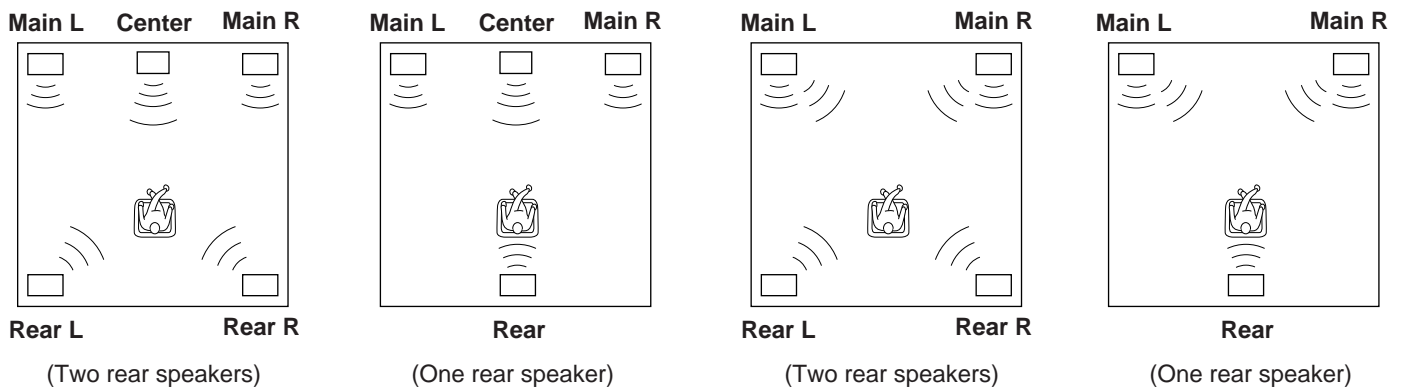

**Note**  
As this unit is equipped with a monaural amplifier for the rear channel, sounds output from the rear speakers are in monaural. So, you may use one rear speaker only instead of using two rear speakers. However, the use of two rear speakers is recommended when there are more than one listener in the listening room.  
When using one rear speaker, place it right behind your listening position.

## SPEAKER PLACEMENT

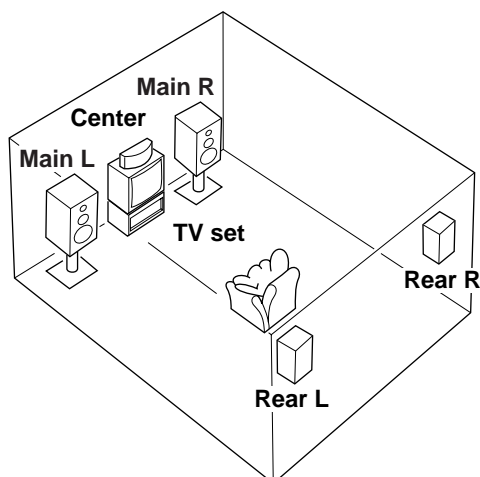

The recommended speaker configuration, the 5-speaker configuration, will require two speaker pairs: **main speakers** (your normal stereo speakers), and **rear speakers**, plus a **center speaker**. When you place these speakers, refer to the following.

- Main:** In normal position. (The position of your present stereo speaker system.)
- Rear:** Behind your listening position, facing slightly inward. Nearly 1.8 m (approx. six feet) up from the floor.
- Center:** Precisely between the main speakers. (To avoid interference with TV sets, use a magnetically shielded speaker.)

# CONNECTIONS

Never plug in this unit and other components until all connections are completed.

## CONNECTIONS WITH OTHER COMPONENTS

When making connections between this unit and other components, be sure all connections are made correctly, that is to say L (left) to L, R (right) to R, “+” to “+” and “-” to “-”. Also, refer to the owner’s manual for each component to be connected to this unit.

\* If you have YAMAHA components numbered as 1, 2, 3, etc. on the rear panel, connections can be made easily by making sure to connect the output (or input) terminals of each component to the same-numbered terminals of this unit.

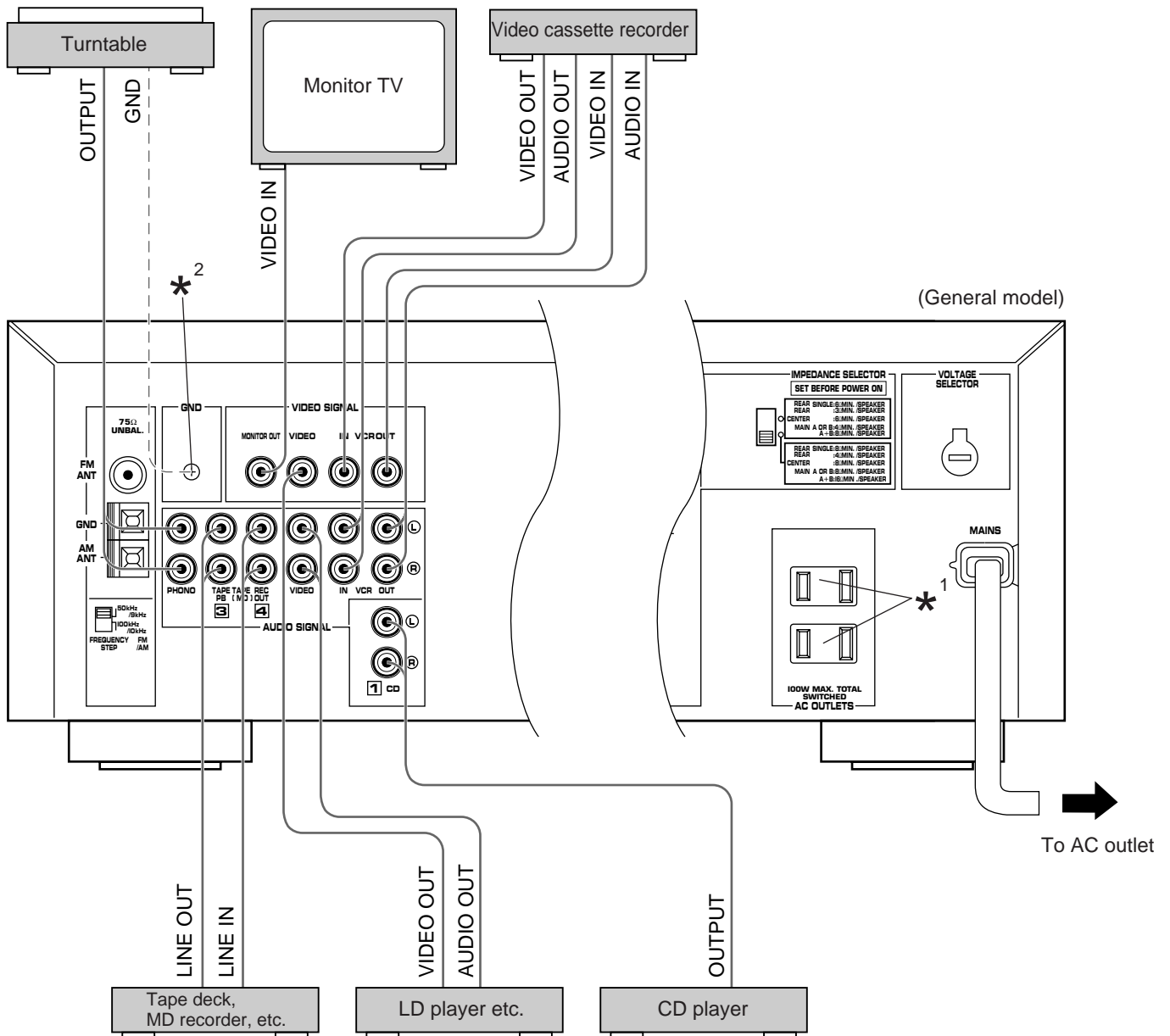

\*<sup>1</sup>, \*<sup>2</sup> : See page 10.

# CONNECTING SPEAKERS

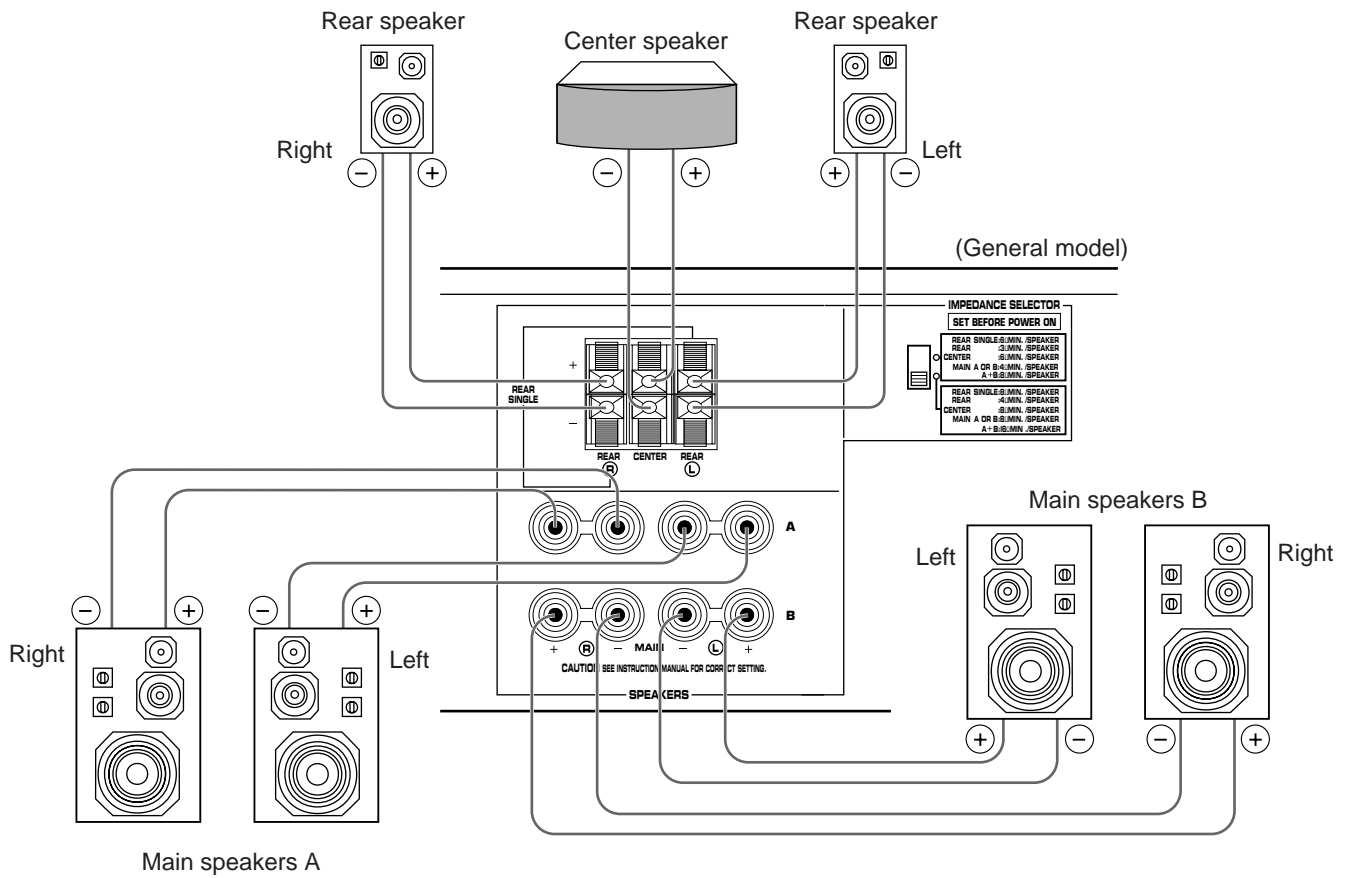

**Note**  
Use speakers with the specified impedance shown on the rear of this unit.

**Note on rear speaker connection:**  
Only one rear speaker can also be used in place of two rear speakers. For connecting one rear speaker, follow the method shown below.

**Note on main speaker connections:**  
One or two speaker systems can be connected to this unit. If you use only one speaker system, connect it to either the **SPEAKERS A** or **B** terminals.

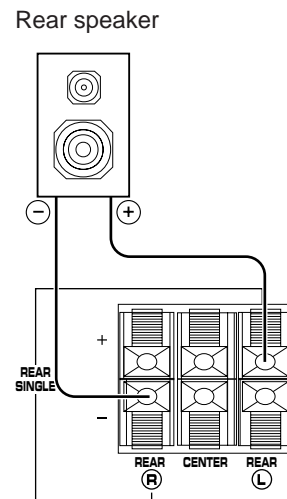



## How to Connect:

Connect the **SPEAKERS** terminals to your speakers with wire of the proper gauge, cut as short as possible. If the connections are faulty, no sound will be heard from the speakers. Make sure that the polarity of the speaker wires is correct, that is the + and – markings are observed. If these wires are reversed, the sound will be unnatural and lack bass.

### Caution

**Do not let the bare speaker wires touch each other and do not let them touch any metal part of this unit. This could damage this unit and/or speakers.**

#### For connecting to the MAIN SPEAKERS terminals

Red: positive (+)  
Black: negative (-)

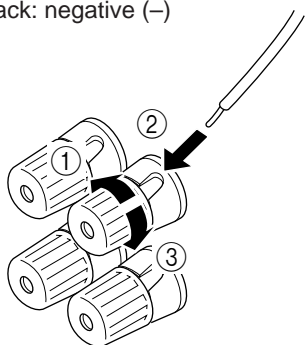

- ① Unscrew the knob.
- ② Insert the bare wire.  
[Remove approx. 5mm (1/4") insulation from the speaker wires.]
- ③ Tighten the knob and secure the wire.

#### For connecting to the REAR and CENTER SPEAKERS terminals

Red: positive (+)  
Black: negative (-)

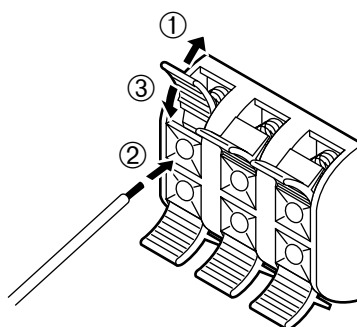

- ① Press up and hold the tab.
- ② Insert the bare wire.  
[Remove approx. 5mm (1/4") insulation from the speaker wires.]
- ③ Release the tab and secure the wire.

Banana Plug connections are also possible (except Singapore model). Simply insert the Banana Plug connector into the corresponding terminal.

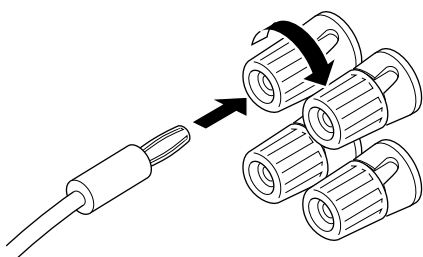

## IMPEDANCE SELECTOR switch

Be sure to switch this only when the power of this unit is turned off.

Select the position whose requirements your speaker system meets.

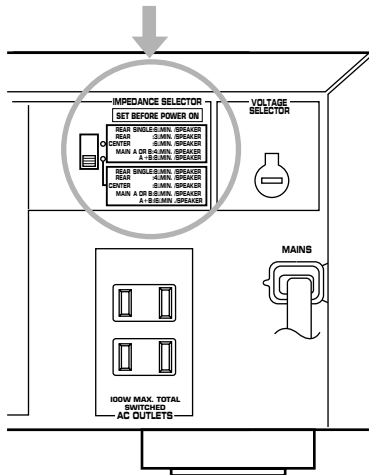

(General model)

### WARNING

Do not change the **IMPEDANCE SELECTOR** switch setting while the power to this unit is on, otherwise this unit may be damaged.

### IF THIS UNIT FAILS TO TURN ON WHEN THE POWER SWITCH IS PRESSED

The **IMPEDANCE SELECTOR** switch may not be set to either end closely. If so, set the switch to either end closely.

 (Upper position)

**Rear:** If you use one rear speaker, the impedance of the speaker must be 6Ω or higher.  
If you use two rear speakers, the impedance of each speaker must be 3Ω or higher.

**Center:** The impedance of the center speaker must be 6Ω or higher.

**Main:** If you use one pair of main speakers, the impedance of each speaker must be 4Ω or higher.  
If you use two pairs of main speakers, the impedance of each speaker must be 8Ω or higher.

 (Lower position)

**Rear:** If you use one rear speaker, the impedance of the speaker must be 8Ω or higher.  
If you use two rear speakers, the impedance of each speaker must be 4Ω or higher.

**Center:** The impedance of the center speaker must be 8Ω or higher.

**Main:** If you use one pair of main speakers, the impedance of each speaker must be 8Ω or higher.  
If you use two pairs of main speakers, the impedance of each speaker must be 16Ω or higher.

## ABOUT THE ACCESSORY TERMINALS

### 2 AC OUTLETS (SWITCHED) ★<sup>1</sup>

Use these to connect the power cords from your components to this unit.

The power to the **SWITCHED** outlets is controlled by this unit's **POWER** switch or the provided remote control transmitter's **POWER** key. These outlets will supply power to any component whenever this unit is turned on.

The maximum power (total power consumption of components) that can be connected to the **SWITCHED AC OUTLETS** is 100 watts.

### GND terminal (For turntable use) ★<sup>2</sup>

Connecting the ground wire of the turntable to the **GND** terminal will normally minimize hum, but in some cases better results may be obtained with the ground wire disconnected.

## ANTENNA CONNECTIONS

- Each antenna should be connected to the designated terminals correctly, referring to the following diagram.
- Both AM and FM indoor antennas are included with this unit. In general, these antennas will probably provide sufficient signal strength. Nevertheless, a properly installed outdoor antenna will give clearer reception than an indoor one. If you experience poor reception quality, an outdoor antenna may result in improvement.

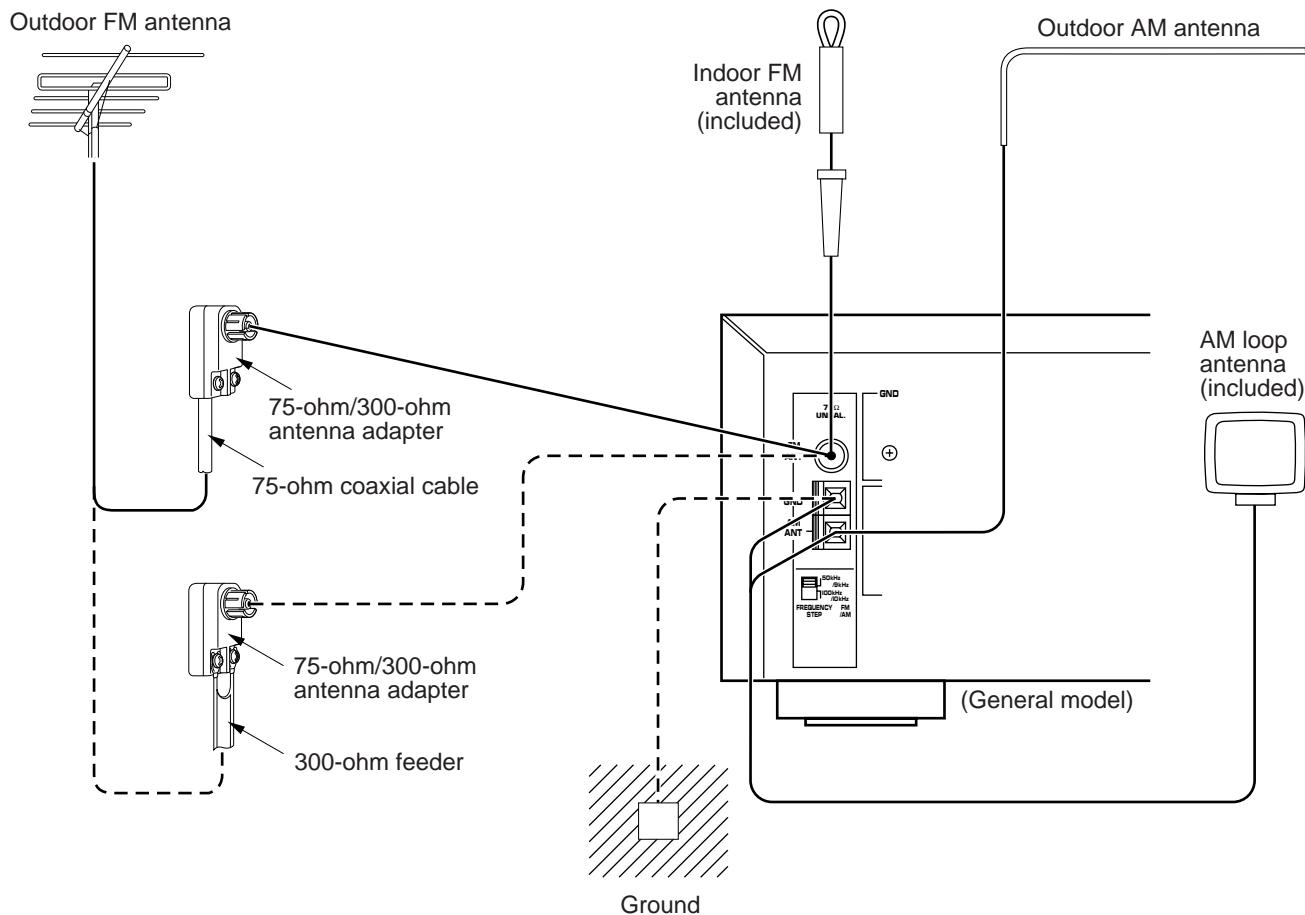

### Connecting the AM loop antenna

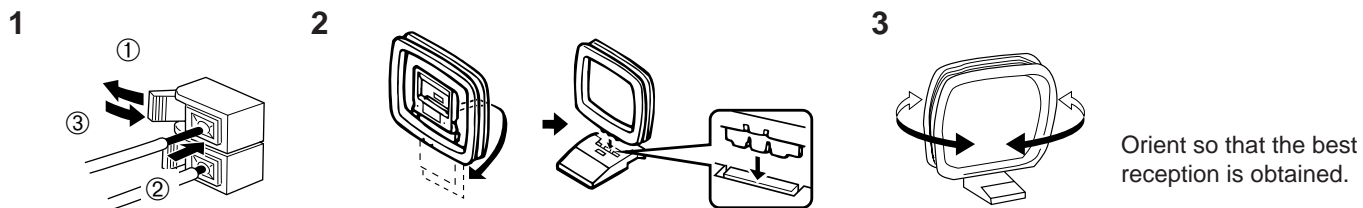

- \* The AM loop antenna should be placed apart from the main unit. The antenna may be hung on a wall.
- \* The AM loop antenna should be kept connected, even if an outdoor AM antenna is connected to this unit.

### GND terminal

For maximum safety and minimum interference, connect the **GND** terminal to a good earth ground. A good earth ground is a metal stake driven into moist earth.

### Notes

- When connecting the indoor FM antenna, insert its connector into the **FM ANT** terminal firmly.
- If you need an outdoor FM antenna to improve FM reception quality, either 300-ohm feeder or coaxial cable may be used. In locations troubled by electrical interference, coaxial cable is preferable.

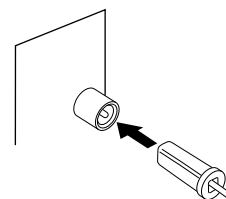

# CONTROLS AND THEIR FUNCTIONS

## FRONT PANEL

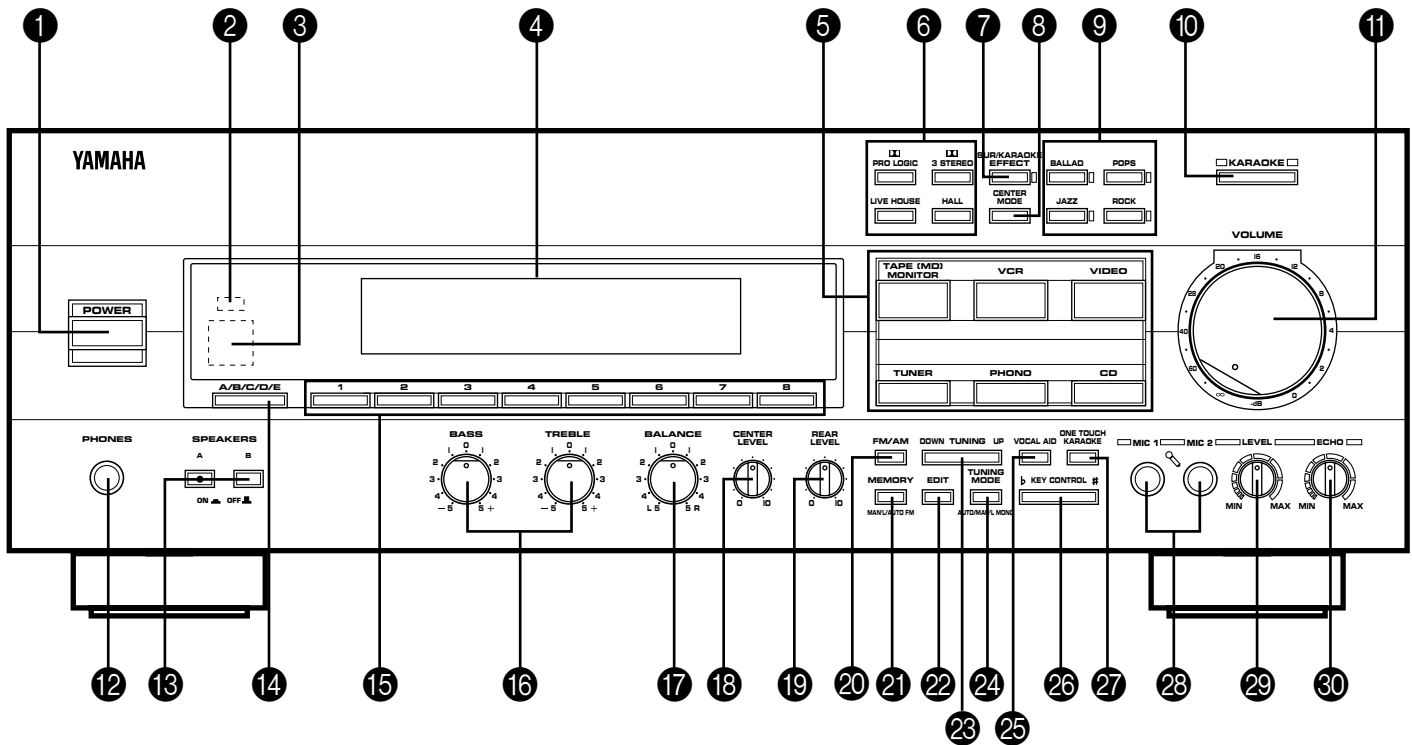

### 1 POWER switch

Press this switch to switch the power on. Press it again to switch the power off.

### 2 Standby mode indicator (Except U.S.A. model)

While the power is on, pressing the **POWER** key on the remote control transmitter switches the unit to the standby mode. In this mode, this indicator is illuminated.

### 3 Remote control sensor

Receives signals from the remote control transmitter.

### 4 Display panel

Shows various information. (Refer to page 16 for details.)

### 5 Input selector buttons

Select a program source to listen to or watch. When a button is pressed, the name of selected source appears on the display.

### 6 DSP program selector buttons ( PRO LOGIC, 3 STEREO, LIVE HOUSE, HALL)

Select a DSP program. When a button is pressed, the name of selected program lights up on the display.

### 7 SUR/KARAOKE EFFECT button

When the built-in digital sound field processor (DSP) (including the Dolby Pro Logic Surround decoder) is on, pressing this button cancel it and turns this unit into the normal 2-channel stereo mode.

Pressing this button once more turns the DSP on and restores the program which was selected the last time.

\* If this button is pressed when a normal DSP program (  PRO LOGIC,  3 STEREO, LIVE HOUSE or HALL) is selected, "EFFECT OFF" lights up on the display, however, if pressed when a DSP program for Karaoke (BALLAD, POPS, JAZZ or ROCK) is selected, "E. OFF" appears on the display.

### 8 CENTER MODE button

Selects a center channel output mode (NORMAL, WIDE or PHANTOM). Changing the center channel output mode is effective only when the program,  PRO LOGIC or  3 STEREO is selected. (For details, refer to page 17.)

\* When the DOLBY 3 STEREO program is used, the "PHANTOM" mode cannot be selected.

### 9 DSP program selector buttons for Karaoke (BALLAD, POPS, JAZZ, ROCK)

Select a DSP program. When a button is pressed, the name of selected program appears on the display.

### 10 KARAOKE button

Pressing this button switches this unit from the state in which a normal DSP program (  PRO LOGIC,  3 STEREO, LIVE HOUSE or HALL) is selected to the state in which a DSP program for Karaoke (BALLAD, POPS, JAZZ or ROCK) is selected, and vice versa. If switched, the program which was used the last time in each state is recalled.

Pressing this button also switches the function of the **SUR/KARAOKE EFFECT** button from turning on/off a normal DSP program to turning on/off a program for Karaoke, and vice versa.

### 11 VOLUME control

Used to raise or lower the volume level.

**12 PHONES jack**

When you listen with headphones, connect the headphones to the **PHONES** jack. You can listen to the sound to be output from the main speakers through headphones. When listening with headphones privately, set both the **SPEAKERS A**

and **B** switches to the **OFF** position and switch off the digital sound field processor by pressing the **SUR/KARAOKE EFFECT** button on the front panel or the **EFFECT ON/OFF** key on the remote control transmitter.

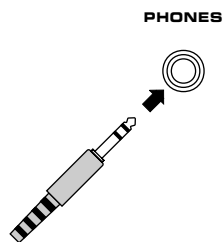
**13 SPEAKERS switches**

Set the switch **A** or **B** (or both **A** and **B**) for the main speaker system (connected to this unit) you will use to the **ON** position. Set the switch for the main speaker system you will not use to the **OFF** position.

**14 A/B/C/D/E button**

Press this button to select a desired group (A–E) of preset stations.

**15 Preset station number selector buttons**

Select a preset station number (1 to 8).

**16 Tone controls**

These controls are effective only for the sound from the main speakers.

**BASS**

Used to increase or decrease the low frequency response. The 0 position produces flat response.

**TREBLE**

Used to increase or decrease the high frequency response. The 0 position produces flat response.

**17 BALANCE control**

Adjusts the balance of the output volume to the left and right speakers to compensate for sound imbalance caused by speaker location or listening room conditions.

**18 CENTER LEVEL control**

Adjusts the sound output level of the center speaker.

**19 REAR LEVEL control**

Adjusts the sound output level of the rear speakers.

**20 FM/AM button**

Press this button to switch the reception band to FM or AM.

**21 MEMORY (MAN'L/AUTO FM) button**

When this button is pressed, the MEMORY indicator flashes for about 5 seconds. During this period, select a desired preset station number by pressing the corresponding preset station number selector button to enter the displayed station into the memory.

When this button is pressed and held for about 3 seconds, the automatic preset tuning begins. (Refer to page 24 for details.)

**22 EDIT button**

This button is used to exchange the places of two preset stations with each other.

**23 TUNING DOWN/UP button**

Used for tuning. Press the "UP" side to tune in to higher frequencies, and press the "DOWN" side to tune in to lower frequencies.

**24 TUNING MODE (AUTO/MAN'L MONO) button**

Press this button to switch the tuning mode to automatic or manual. To select the automatic tuning mode, press this button so that "AUTO" lights up on the display. To select the manual tuning mode, press this button so that "AUTO" goes off.

**25 VOCAL AID button**

This button functions only when a DSP program for Karaoke, BALLAD, POPS, JAZZ or ROCK is selected, or the DSP is turned off (so that "E. OFF" appears on the display). Pressing this button so that "VOCAL AID" lights up on the display turns this function on, and whenever this button is pressed, one of three audio output modes is selected in turn. When the "VOCAL CUT" mode is selected, while playing a source, medium frequencies (vocals, etc.) of the source sound are attenuated only when there is an input from the microphone.

To cancel this function, press this button once or more until "VOCAL AID" goes off from the display.

This button is useful for singing Karaoke using a normal audio source with vocals or a multisound source for Karaoke use.

**26 KEY CONTROL button**

This button functions only when a DSP program for Karaoke, BALLAD, POPS, JAZZ or ROCK is selected, or the DSP is off. Pressing this button changes key of the tune currently playing. The current key level is shown on the display.

**b** (Left side): Whenever this side is pressed, key of the track becomes lower.

**#** (Right side): Whenever this side is pressed, key of the track becomes higher.

**27 ONE TOUCH KARAOKE button**

This button functions only when a DSP program for Karaoke, BALLAD, POPS, JAZZ or ROCK is selected, or the DSP is turned off (so that "E. OFF" appears on the display). Pressing this button so that "ONE TOUCH KARAOKE" lights up on the display turns this function on, and whenever this button is pressed, one of three audio output modes is selected in turn. When the "VOCAL CUT" mode is selected, medium frequencies (vocals, etc.) of the playing source sound are attenuated.

To cancel this function, press this button once or more until "ONE TOUCH KARAOKE" goes off from the display.

This button is useful for singing Karaoke using a normal audio source with vocals or a multisound source for Karaoke use.

**28 MIC jacks**

One or two microphones can be connected to these jacks. These are available when a DSP program for Karaoke, BALLAD, POPS, JAZZ or ROCK is selected, or the DSP is off.

**29 MIC LEVEL control**

This control functions only when a DSP program for Karaoke, BALLAD, POPS, JAZZ or ROCK is selected, or the DSP is off. This control adjusts the level of sound signals input from the microphone(s) connected to this unit's MIC jacks.

**30 ECHO level control**

This control functions only when a DSP program for Karaoke, BALLAD, POPS, JAZZ or ROCK is selected, or the DSP is off. This control adjusts the level of echo applied to sound signals input from the microphone(s) connected to this unit's MIC jacks.

# REMOTE CONTROL TRANSMITTER

The remote control transmitter provided with this unit is designed to control all the most commonly used functions of this unit. If the CD player and tape deck connected to this unit are YAMAHA components designed for remote control compatibility, then this remote control transmitter will also control various functions of each component.

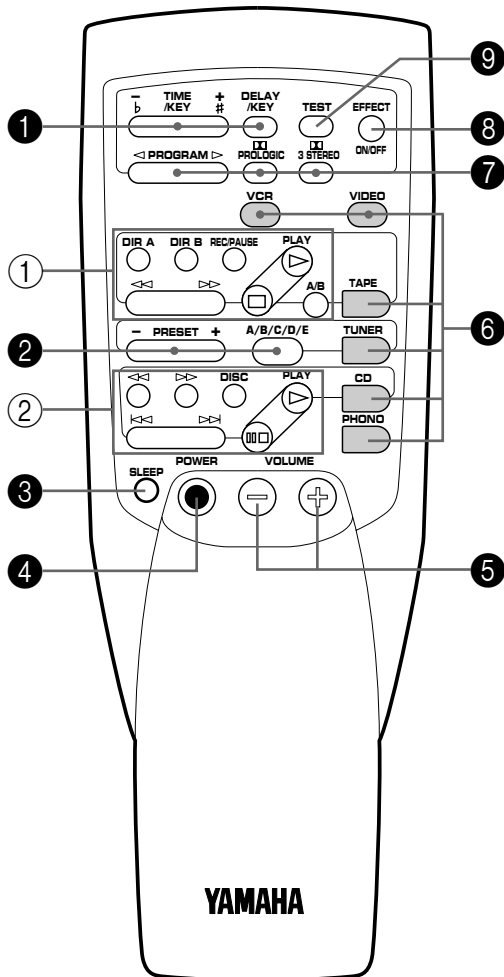

## For Control of This Unit

### 1 DELAY/KEY and TIME/KEY – (b)/+ (#) keys

Adjust the delay time (DELAY) and key level of the currently playing tune (KEY).

Select the item which you want to adjust by pressing the **DELAY/KEY** key and adjust its time or level by pressing the **TIME/KEY – (b)/+ (#)** key.

\* The key level cannot be changed when a normal DSP program (  PRO LOGIC,  3 STEREO, LIVE HOUSE or HALL ) is selected.

### 2 Tuner keys

Controls tuner.

**+**: Selects higher preset station number.

**-**: Selects lower preset station number.

**A/B/C/D/E**: Selects the group (A – E) of preset station numbers.

### 3 SLEEP timer key

This key is used to turn the built-in SLEEP timer on and off, and to set the SLEEP time. (See page 32 for details.)

### 4 POWER key

Turns the power on/off.

\* (Except U.S.A. model)

While the power is on, pressing the **POWER** key on the remote control transmitter switches the unit from the power-on mode to the standby mode, and vice versa. (In the standby mode, the standby mode indicator on the front panel is illuminated.)

### 5 VOLUME +/- keys

Turns the volume level up/down.

### 6 Input selector keys

Selects input source.

### 7 Program selector keys

#### PROGRAM:

When the built-in digital sound field processor (including the Dolby Pro Logic Surround decoder) is on, this key changes the currently selected DSP program whenever the right or left side of this key is pressed.

When a normal DSP program (  PRO LOGIC,  3 STEREO, LIVE HOUSE or HALL ) is selected, a program change is made among them. When a DSP program for Karaoke (BALLAD, POPS, JAZZ or ROCK ) is selected, a program change is made among them.

#### PROLOGIC:

Directly selects the  PRO LOGIC program.

#### 3 STEREO:

Directly selects the  3 STEREO program.

### 8 EFFECT ON/OFF key

When the built-in digital sound field processor (DSP) (including the Dolby Pro Logic Surround decoder) is on, pressing this key cancel it and turns this unit into the normal 2-channel stereo mode. If this key is pressed when a normal DSP program (  PRO LOGIC,  3 STEREO, LIVE HOUSE or HALL ) is selected, "EFFECT OFF" lights up on the display, however, if pressed when a DSP program for Karaoke (BALLAD, POPS, JAZZ or ROCK) is selected, "E. OFF" appears on the display. Pressing this key once more turns the DSP on and restores the program which was selected the last time.

### 9 TEST key

Used for speaker balance adjustment. (For details, refer to page 17–18.)

## For Other Component Control

Identify the remote control transmitter keys with your component's keys. If these keys are identical, their functions will be the same. On each key function, refer to the corresponding instruction on your component's manual.

### ① Tape deck keys

Controls tape deck.

\* **DIR A, B** and **A/B** are applicable only to double cassette tape deck.

\* For a single cassette deck with automatic reverse function, pressing **DIR A** will reverse the direction of tape running.

### ② CD player keys

Controls compact disc player.

\* **DISC** is applicable only to compact disc changer.

## Notes about the remote control transmitter

### Battery installation

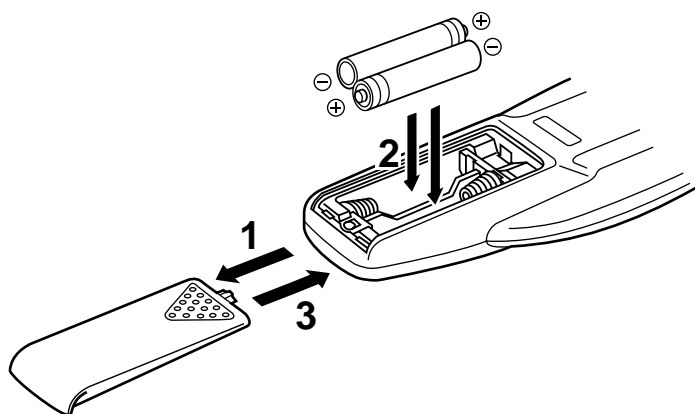

### Battery replacement

If you find that the remote control transmitter must be used closer to the main unit, the batteries are weak. Replace both batteries with new ones.

#### Notes

- Use only AA, R6, UM-3 batteries for replacement.
- Be sure the polarities are correct. (See the illustration inside the battery compartment.)
- Remove the batteries if the remote control transmitter will not be used for an extended period of time.
- If batteries leak, dispose of them immediately. Avoid touching the leaked material or letting it come in contact with clothing, etc. Clean the battery compartment thoroughly before installing new batteries.

### Remote control transmitter operation range

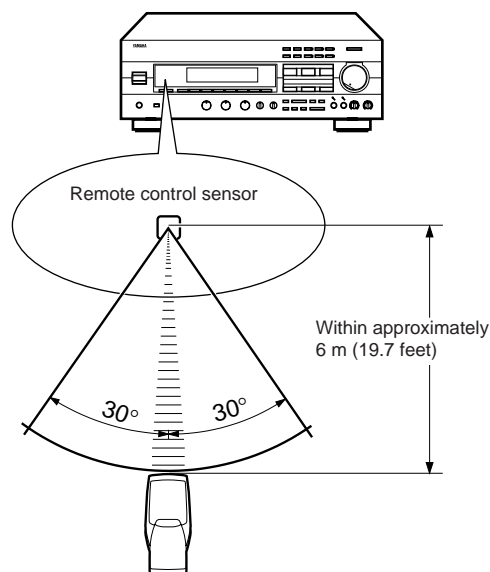

#### Notes

- There should be no large obstacles between the remote control transmitter and the main unit.
- If the remote control sensor is directly illuminated by strong lighting (especially an inverter type of fluorescent lamp etc.), it might cause the remote control transmitter not to work correctly. In this case, reposition the main unit to avoid direct lighting.

## DISPLAY PANEL

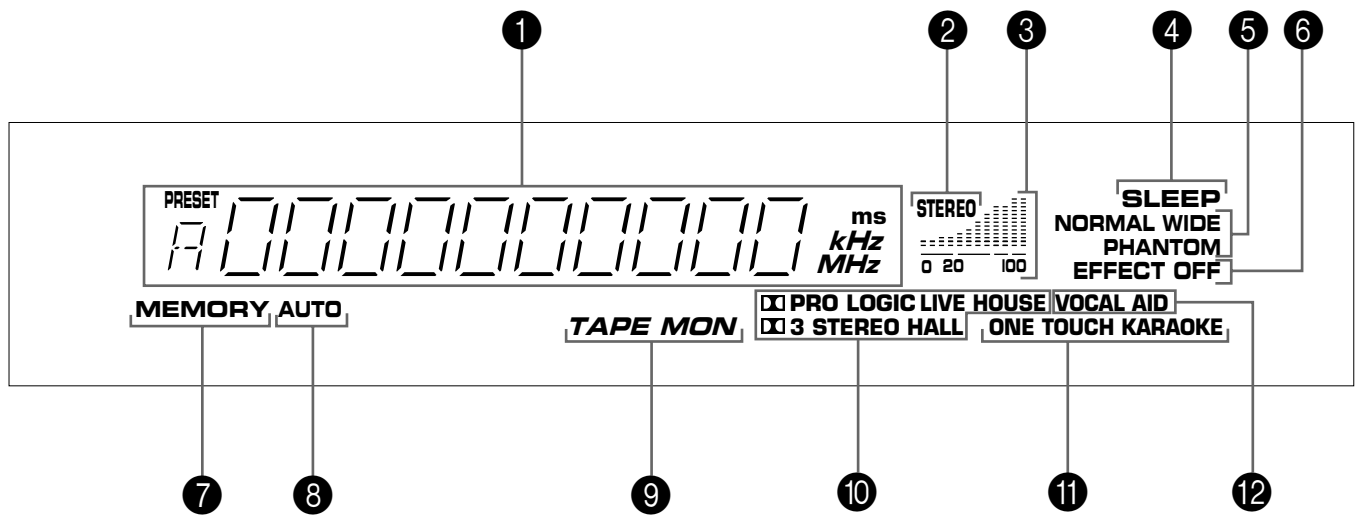

### 1 Multi-information display

Displays various information, for example station frequency, preset station number and name of selected input source.

### 2 STEREO indicator

Lights up when an FM stereo broadcast with sufficient signal strength is received.

### 3 Signal-level meter

Indicates the signal level of the received station. If multipath interference is detected, the indication decreases.

### 4 SLEEP indicator

Lights up while the built-in SLEEP timer is functioning.

### 5 Center channel mode indicators

The name of a selected center channel mode lights up only when the DSP program,  PRO LOGIC or  3 STEREO is selected.

### 6 EFFECT OFF indicator

Lights up if the digital sound field processor including the Dolby Pro Logic Surround decoder is turned off by pressing the **SUR/KARAOKE EFFECT** button on the front panel or the **EFFECT ON/OFF** key on the remote control transmitter when a normal DSP program ( PRO LOGIC,  3 STEREO, LIVE HOUSE or HALL) is selected. In this state, sound output is 2-channel stereo.

### 7 MEMORY indicator

When the **MEMORY** button is pressed, this indicator flashes for about 5 seconds. During this period, the displayed station can be programmed to the memory by using the **A/B/C/D/E** button and the preset station number selector buttons.

### 8 AUTO indicator

Lights up when this unit is in the automatic tuning mode.

### 9 TAPE MON indicator

Lights up when the tape deck (or MD recorder etc.) is selected as the input source by pressing the **TAPE (MD) MONITOR** button.

### 10 DSP program indicators

When a normal DSP program ( PRO LOGIC,  3 STEREO, LIVE HOUSE or HALL) is selected, its name lights up.

### 11 ONE TOUCH KARAOKE indicator

Lights up by pressing the **ONE TOUCH KARAOKE** button on the front panel. In this mode, you can select one of three audio output modes according as you prefer. If you select the "VOCAL CUT" mode, medium frequencies (vocals, etc.) of the playing source sound are attenuated.

To extinguish this indicator, press the **ONE TOUCH KARAOKE** button once or more.

### 12 VOCAL AID indicator

Lights up by pressing the **VOCAL AID** button on the front panel. In this mode, you can select one of three audio output modes according as you prefer. If you select the "VOCAL CUT" mode, medium frequencies (vocals, etc.) of the playing source sound are attenuated only when there is an input from the microphone(s).

To extinguish this indicator, press the **VOCAL AID** button once or more.



# SPEAKER BALANCE ADJUSTMENT

This procedure lets you adjust the sound output level balance between the main, center, and rear speakers using the built-in test tone generator. When this adjustment is performed, the sound output level heard at the listening position will be the same from each speaker. This is important for the best performance of the digital sound field processor and the Dolby Pro Logic Surround decoder.

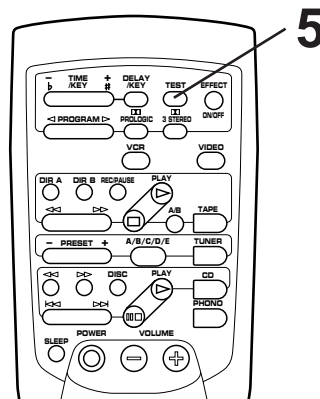
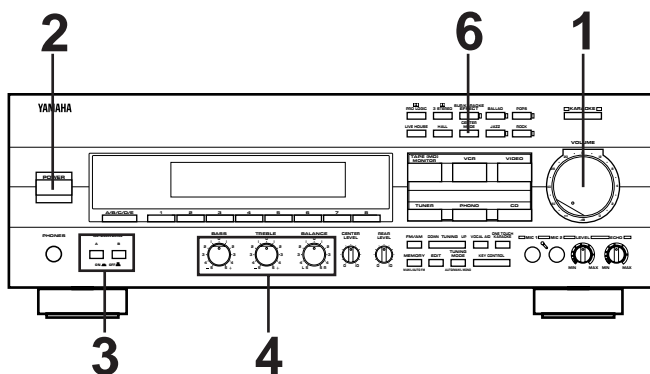

**1**

Set to the "∞" position.

---

**2** Turn the power on.

---

**3** Select the main speakers to be used.

\* If you use two main speaker systems, press both the A and B switches.

---

**4**

Set to the "0" position.

**5**

---

**6** Select the center channel output mode suitable for your speaker configuration. (Refer to "SPEAKER CONFIGURATION" on page 6.)

On the feature of each mode, refer to the "Note" shown below.

**Note**  
In step 6, when you select a center channel output mode, note the following.

**For 5 speaker configuration)**

**NORMAL:** Select this mode when you use a center speaker that is smaller than the main speakers. In this mode, the bass tone will be output from the main speakers.

**WIDE:** Select this mode when you use the center speaker approximately same sized as the main speakers.

**For 4 speaker configuration)**

**PHANTOM:** Select this mode when you do not use the center speaker. The center sound will be output from the left and right main speakers.

\* When the **DOLBY 3 STEREO** program is used, the "PHANTOM" mode cannot be selected.

**CONTINUED**

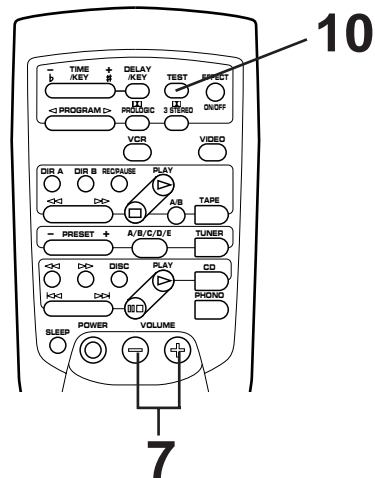
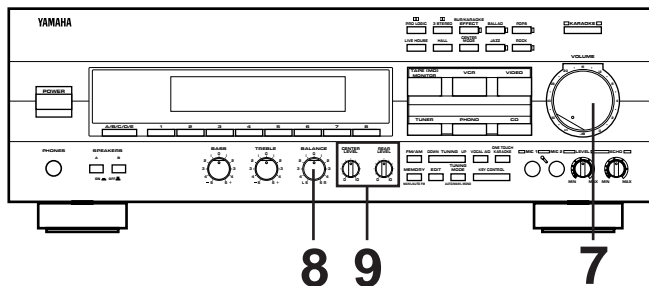

**7** Turn up the volume.

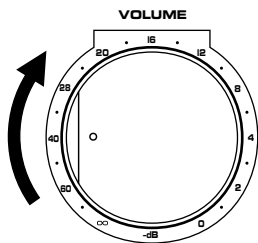

You will hear a test tone (like pink noise) from the left main speaker, then the center speaker, then the right main speaker, and then the rear speakers, for about two seconds each. The display changes as shown below.

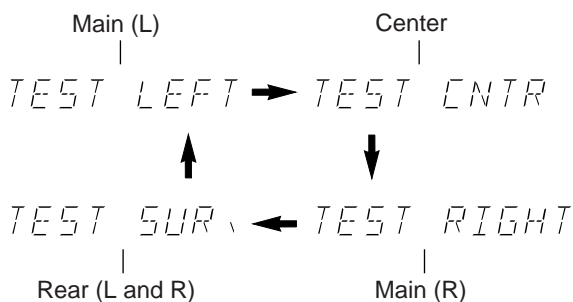

\* The test tone from the left rear speaker and the right rear speaker will be heard at the same time.

**8** Adjust the **BALANCE** control so that the effect sound output level of the left main speaker and the right main speaker are the same.



**9** Adjust the sound output levels of the center speaker and the rear speakers so that they become almost as same as that of the main speakers.

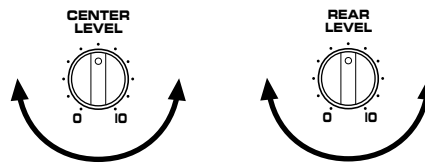

**10** Cancel the test tone.

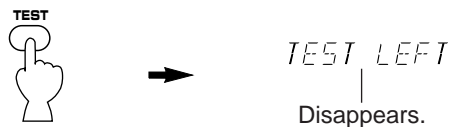

**Notes**

- Once you have completed these adjustments, you can adjust whole sound level on your audio system by using the **VOLUME** control (or the **VOLUME** keys on the remote control transmitter) only.
- If you use external power amplifiers, you may also use their volume controls to achieve proper balance.
- In step 9, if the center channel mode is in the "PHANTOM" position, the sound output level of the center speaker cannot be adjusted. This is because in this mode, the center sound is automatically output from the left and right main speakers.

# BASIC OPERATIONS

## TO PLAY A SOURCE

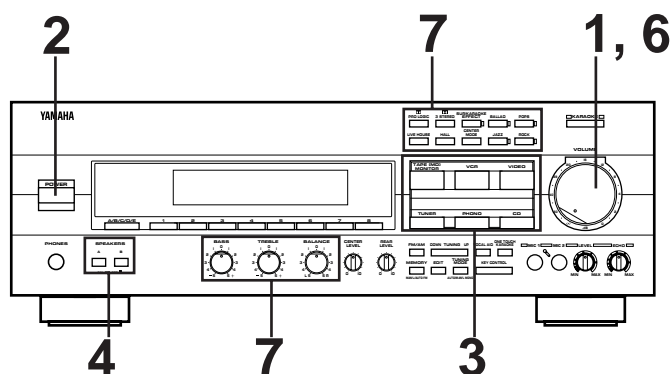

**1**

Set to the "∞" position.

**2** Turn the power on.

**3** Select the desired input source by using the input selector buttons.  
(For video sources, turn the TV/monitor ON.)

\* The name of the selected input source will appear on the display.

**4** Select the main speakers to be used.

\* If you use two main speaker systems, press both the A and B switches.

**5** Play the source. (For detailed information on the tuning operation, refer to page 22.)

**6**

Adjust to the desired output level.

**7** If desired, adjust the **BASS**, **TREBLE** and **BALANCE** controls (refer to page 21), and use the digital sound field processor. (Refer to page 27.)  
To enjoy singing Karaoke by using this unit, refer to pages 29 to 31.

### Notes on using the input selector buttons

- Note that pressing on each input selector button selects the source which is connected to the corresponding input terminals on the rear panel.
- The selection of **TAPE (MD) MONITOR** cannot be canceled by pressing another input selector button. To cancel it, press **TAPE (MD) MONITOR** again so that "TAPE MON" disappears from the display. When you select a button other than **TAPE (MD) MONITOR**, make sure that "TAPE MON" is not illuminated on the display.
- If you select the input selector button for a video source without canceling the selection of **TAPE (MD) MONITOR**, the playback result will be the video image from the video source and the sound from the audio tape (or MD etc.).
- Once you play a video source, its video image will not be interrupted even if the input selector button for an audio source is selected.

### To turn off the power

Press the **POWER** switch again.

## TO RECORD A SOURCE TO TAPE (OR MD)

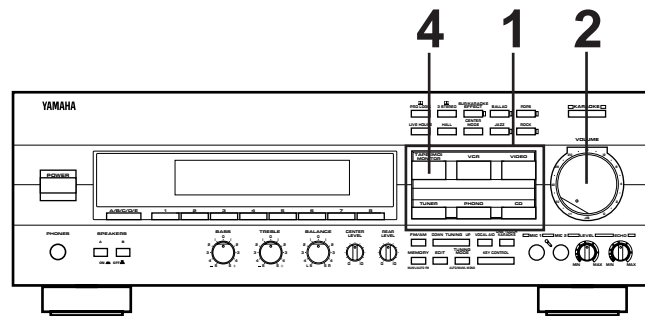

- 1** Select the source to be recorded.

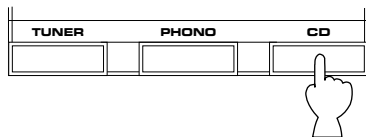

- 2** Play the source and then turn the **VOLUME** control up to confirm the input source. (For detailed information on the tuning operations, refer to the page 22.)

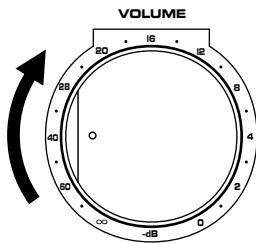

- 3** Begin recording on the tape deck (or MD recorder etc.) or VCR connected to this unit.

- 4** If the tape deck (or MD recorder etc.) is used for recording, you can monitor the sounds being recorded by pressing **TAPE (MD) MONITOR** so that "TAPE MON" lights up on the display.

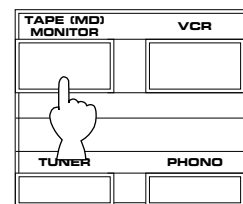

### Notes

- The settings of DSP and the **VOLUME**, **BASS**, **TREBLE** and **BALANCE** controls have no effect on the material being recorded.
- You can also record your vocal input from the microphone(s) connected to this unit along with the source. In addition, an effect sound of DSP program for Karaoke and effects of Karaoke functions can also be recorded with the vocal and the source. (See page 31 for details.)

## Selecting the SPEAKER system

Because one or two speaker systems (as main speakers) can be connected to this unit, the **SPEAKERS** switches allow you to select speaker system **A** or **B**, or both at once.

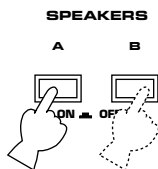

## Adjusting the BALANCE control

Adjust the balance of the output volume to the left and right speakers to compensate for sound imbalance caused by speaker location or listening room conditions.



### Note

This control is effective only for the sound from the main speakers.

## Adjusting the BASS and TREBLE controls

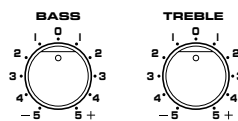

**BASS** : Turn this clockwise to increase (or counter-clockwise to decrease) the low frequency response.

**TREBLE** : Turn this clockwise to increase (or counter-clockwise to decrease) the high frequency response.

### Note

These controls are effective only for the sound from the main speakers.

# TUNING OPERATIONS

Normally, if station signals are strong and there is no interference, quick automatic-search tuning (AUTOMATIC TUNING) is possible. However, if signals of the station you want to select are weak, you must tune to it manually (MANUAL TUNING).

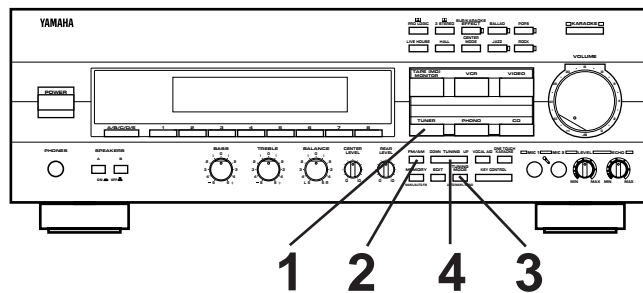

## AUTOMATIC TUNING

**1** Select "TUNER" as the input source.

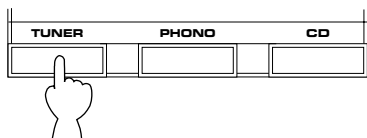

**2** Select the reception band (FM or AM) confirming it on the display.

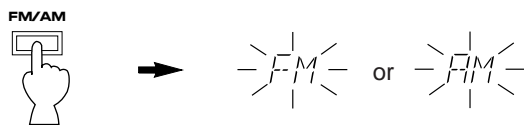

**3** Turn "AUTO" on.

**4** Tune to a desired station manually.

To tune to a higher frequency, press the right side once.  
 To tune to a lower frequency, press the left side once.  
 \* If the station where tuning search stops is not the desired one, press again.  
 \* If the tuning search does not stop at the desired station (because the signals of the station are weak), change to the MANUAL TUNING method.

## MANUAL TUNING

**1** Select "TUNER" as the input source.

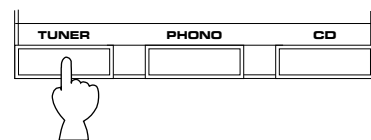

**2** Select the reception band (FM or AM) confirming it on the display.

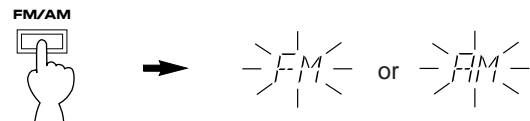

**3** Turn "AUTO" off.

**4** Tune to a desired station manually.

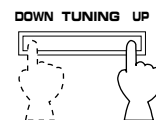

\* To continue tuning search, press and hold the button.

**Note**  
 If you tune to an FM station manually, it is received in monaural mode automatically to increase the signal quality.

# PRESET TUNING

## MANUAL PRESET TUNING

This unit can store station frequencies selected by tuning operation. With this function, you can recall any desired station by only selecting the preset station number where it is stored. Up to 40 stations (8 stations x 5 groups) can be stored.

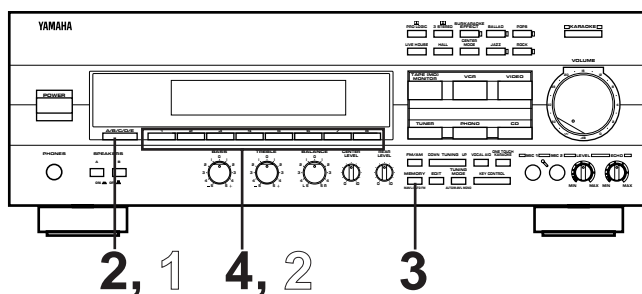

### To store stations

**1** Tune to a desired station.  
(Refer to the previous page for tuning procedure.)

**2** Select a desired group (A – E) of preset stations confirming it on the display.



**3** **MEMORY** button flashes on and off for about 5 seconds.

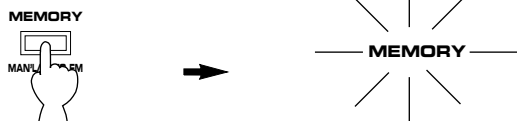

**4** Select a preset station number where you want to program the station before “MEMORY” goes off from the display.

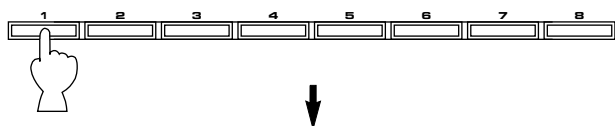

Shows the displayed station has been programmed to A1.

- \* In the same way, program other stations to A2, A3 ... A8.
- \* You can program more stations to preset station numbers on other groups in the same way by selecting other groups in step 2.

### To recall a preset station

**1** Select the group of preset stations.

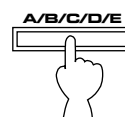

**2** Select the preset station number.

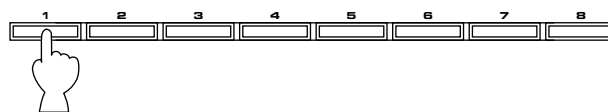

#### Notes

- A new setting can be programmed in place of the former one.
- For presets, the setting of the reception mode (stereo or monaural) is stored along with the station frequency.

#### Memory back-up

The memory back-up circuit prevents the programmed data from being lost even if the **POWER** switch is set off or the power plug is disconnected from the AC outlet or the power is cut due to temporary power failure. If, however, the power is cut for more than one week, the memory may be erased. If so, it can be re-programmed by simply following the PRESET TUNING steps.

## AUTOMATIC PRESET TUNING

You can also make use of an automatic preset tuning function for FM stations only. By this function, this unit performs automatic tuning and stores FM stations with strong signals sequentially. Up to 40 stations are stored automatically in the same way as in the manual preset tuning method on page 23.

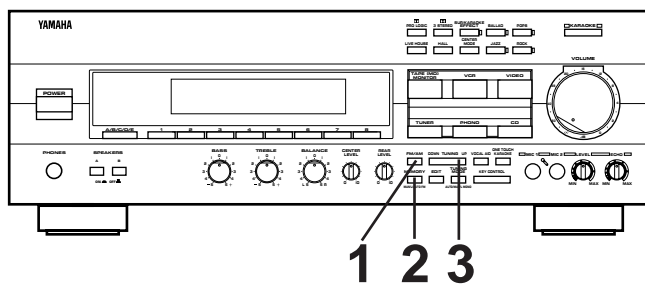

### To store stations

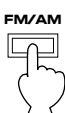
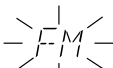
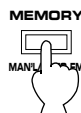
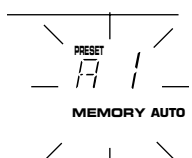
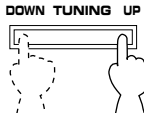
<b>1</b>	 
<b>2</b>	  <p>Press and hold for about 3 seconds.</p> <p style="text-align: center;">Flashes.</p>
<b>3</b>	 <p>To tune to higher frequencies, press right side once. To tune to lower frequencies, press left side once. * If the <b>TUNING</b> button is not pressed, in a while, the automatic preset tuning begins automatically toward higher frequencies.</p> <p>The automatic preset tuning begins from the frequency currently displayed. Received stations are programmed to A1, A2 ... A8 sequentially. * If more than 8 stations are received, they are also programmed to the preset station numbers on other groups (B, C, D and E) in that order.</p>

### When the automatic preset tuning is finished

The display shows the frequency of the last preset station. Check the contents and the number of preset stations by following the procedure of the section "To recall a preset station" on page 23.

### To recall a preset station

Simply follow the procedure of the section "To recall a preset station" on page 23.

### Notes

- You can replace a preset station by another FM or AM station manually by simply following the procedure of the section "To store stations" on page 23.
- If the number of received stations is not enough to be stored up to E8, the search is finished automatically after searching all frequencies.
- With this function, only FM stations with sufficient signal strength are stored automatically. If the station you want to program is weak in signal strength, tune in to it with the MANUAL TUNING method (in monaural) and program it by following the procedure of the section "To store stations" on page 23.

### If you want to store the first station received by the automatic preset tuning to a desired preset station number.

If, for example, you want to store the first received station to C5, select "C5" by using the **A/B/C/D/E** button and the preset station number selector buttons after pressing the **MEMORY** button in step 2. Then press the **TUNING** button. The first received station is stored to C5, and next stations to C6, C7 ... sequentially.

If stations are stored up to E8, the automatic preset tuning is finished automatically.



# EXCHANGING PRESET STATIONS

You can exchange the places of two preset stations with each other as shown below.

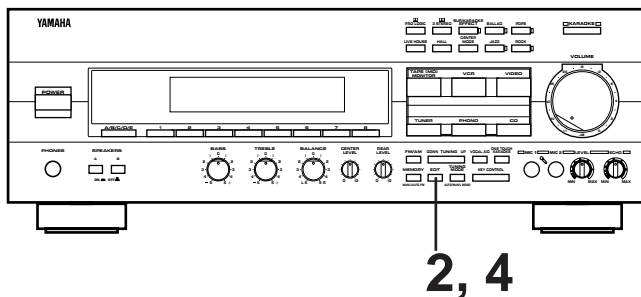

**Example)**

If you want to shift the preset station on E1 to A5, and vice versa.

<b>1</b>	Recall the preset station on E1 (by following the method of "To recall a preset station" on page 23).
<b>2</b>	
<b>3</b>	<p>Next, recall the preset station on A5 by following the same method with step 1.</p>

<b>4</b>	
----------	--

# USING DIGITAL SOUND FIELD PROCESSOR (DSP)

This unit incorporates a sophisticated, multi-program digital sound field processor. The processor allows you to electronically expand and change the shape of the audio sound field from both audio and video sources, creating a theater-like experience in your listening room. You can create an excellent audio sound field by selecting a suitable sound field program (this will, of course, depend on what you will be listening to), and adding desired adjustments.

In addition, this unit incorporates a Dolby Pro Logic Surround decoder for multi-channel sound reproduction of sources encoded with Dolby Surround. The operation of the Dolby Pro Logic Surround decoder can be controlled by selecting a corresponding DSP program.

## Brief Overview of Digital Sound Field Programs

The following list gives you a brief description of the sound fields produced by each of the DSP programs. Keep in mind that most of these are precise digital recreations of actual acoustic environments. The data for these sound fields was recorded at actual locations using sophisticated sound field measurement equipment.

	PROGRAM	FEATURE
For normal DSP-surround effect	<input checked="" type="checkbox"/> PRO LOGIC	This program is used for playback of sources encoded with Dolby Surround. The application of a sophisticated digital signal processing system reduces crosstalk and directs or steers the sound source more smoothly and precisely, as compared to conventional types.
	<input checked="" type="checkbox"/> 3 STEREO	This program is effective not only for playback of sources encoded with Dolby Surround, but also for sources not with Dolby Surround or TV programs with 2-channel stereo sound. With this program, 2-channel stereo sound is converted into 3-channels (left main, center and right main), so the dialogs are emphasized on the center position by the use of the center speaker. As no sound is output from the rear speakers, this program is also effective in a simple Audio/Video system without rear speakers.
	LIVE HOUSE	This program simulates the acoustic environment of a live house. An energetic sound field is created with relatively clear reflections by the wall.
	HALL	In this program, the center will appear to be deep behind the main speakers, creating an expansive large hall ambience.
For Karaoke	BALLAD	Vocals move your heart with deep and clear reverberations. This program is suitable for slow ballads, etc.
	POPS	Vocals are emphasized and whole sound is clear. This program is suitable for pops.
	JAZZ	This is a small, cozy jazz club with a low ceiling. The sound is very close and intimate.
	ROCK	This program is ideally suited for rock music. You will experience a very dynamic or lively sound field.

## To play a source with the digital sound field processor

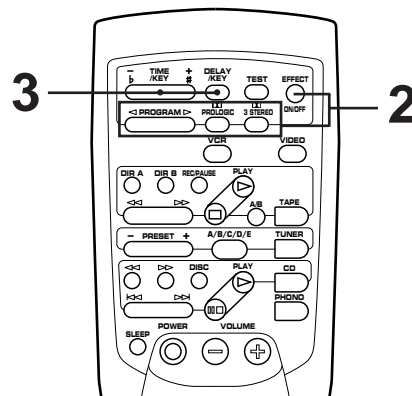
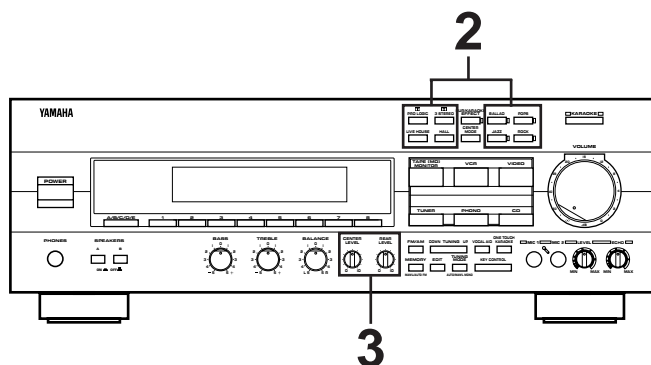

**1** Follow steps 1 – 6 shown in “**BASIC OPERATIONS**” on page 19.

**2** Select the desired program that is suitable for the source.

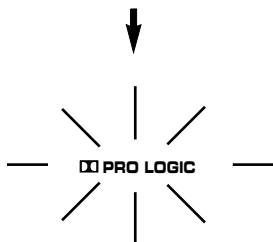
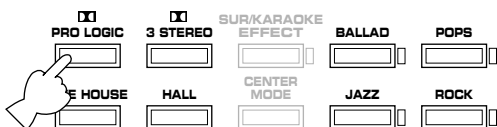

The selected program name is shown on the display.

**3** If desired, adjust the delay time and the output level of each speaker. (For details, refer to the corresponding descriptions on page 28.)

- When a monaural sound source is played with **DOLBY PRO LOGIC** or **DOLBY 3 STEREO**, if the center channel mode is in **WIDE**, no sound is heard from the main speakers and the rear speakers. Sound is heard only from the center speaker. However, if the center channel mode is in **PHANTOM**, the main speakers output the sound of the center channel.
- When this unit's Dolby Pro Logic Surround decoder is used, if the main-source sound is considerably altered by overadjustment of the **BASS** or **TREBLE** control, the relationship between the center and rear channels may produce an unnatural effect.

**To select a DSP program on the remote control transmitter**  
First turn the DSP on so that a program name appears on the display by pressing the **EFFECT ON/OFF** key. Next, select a desired DSP program by pressing the **<** or **>** side of **PROGRAM** key.

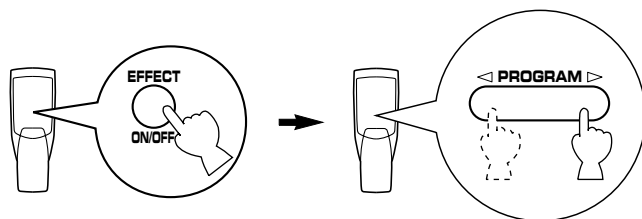

- \* Pressing the **PRO LOGIC** or **3 STEREO** key turns the DSP on and selects the corresponding program directly.

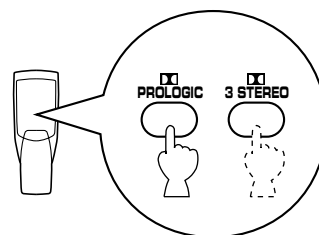

### Notes

- If you prefer to cancel the DSP, press the **SUR/KARAOKE EFFECT** button on the front panel or the **EFFECT ON/OFF** key on the remote control transmitter. The sound will be the normal 2-channel stereo without surround sound effect.
- When **LIVE HOUSE**, **HALL**, **BALLAD**, **POPS**, **JAZZ** or **ROCK** is selected, no sound is heard from the center speaker.

## Adjustment of the CENTER LEVEL

If desired, you can adjust the sound output level of the center speaker even if the output level is already set in "SPEAKER BALANCE ADJUSTMENT" on page 18.

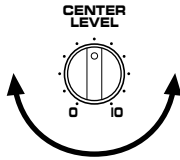

### Note

This adjustment is useful only when the digital sound field program **DOLBY PRO LOGIC** or **DOLBY 3 STEREO** is selected.

## Adjustment of the REAR LEVEL

If desired, you can adjust the sound output level of the rear speakers even if the output level is already set in "SPEAKER BALANCE ADJUSTMENT" on page 18.

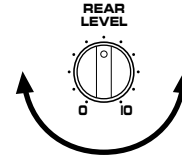

### Notes

- If no digital sound field program is used, this adjustment is useless.
- When the digital sound field program **DOLBY 3 STEREO** is selected, this adjustment is useless.

## Adjustment of DELAY TIME

You can adjust the time difference between the beginning of the sound from the main speakers and the beginning of the effect sound from the rear speakers.

The larger the value, the later the effect sound is generated. This adjustment can be made to all programs (except **3 STEREO**) individually.

### Control range

<b>PRO LOGIC</b>	: from 15 to 30 milliseconds (Preset value: 20 milliseconds)
<b>LIVE HOUSE</b>	: from 1 to 100 milliseconds (Preset value: 20 milliseconds)
<b>HALL</b>	: from 1 to 100 milliseconds (Preset value: 30 milliseconds)
<b>BALLAD</b>	: from 1 to 50 milliseconds (Preset value: 20 milliseconds)
<b>POPS</b>	: from 1 to 50 milliseconds (Preset value: 20 milliseconds)
<b>JAZZ</b>	: from 1 to 50 milliseconds (Preset value: 20 milliseconds)
<b>ROCK</b>	: from 1 to 50 milliseconds (Preset value: 20 milliseconds)

Use the remote control transmitter for adjusting delay time.

- 1 Press once or more so that "DELAY" appears on the display.

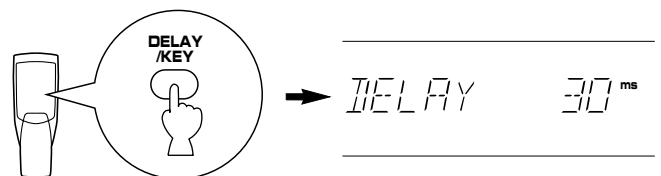

- 2 By continuously pressing the "+" or "-" side of the **TIME/KEY** button, the value changes continuously. The value stops changing momentarily at the preset point.

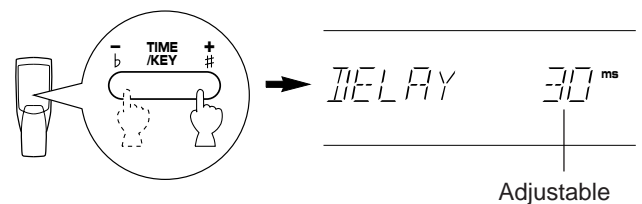

### Note

Adding too much delay will cause an unnatural effect with some sources.

### Notes

The value of the delay time you set the last time will remain memorized even when the power of this unit is off. However, if the power cord is kept disconnected for more than one week, these values will be automatically changed back to the original factory settings.

# ENJOYING KARAOKE

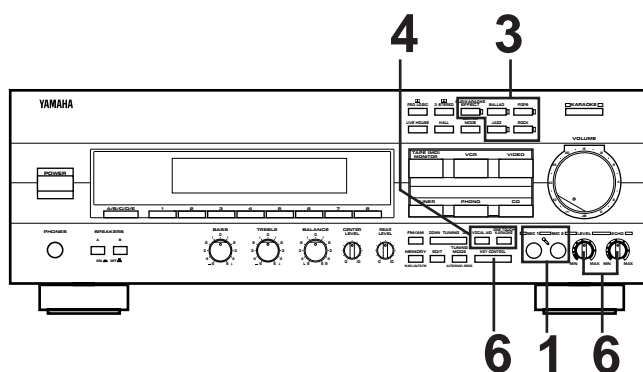

- 1** Connect one or two microphones to the **MIC** jack(s) on the front panel.

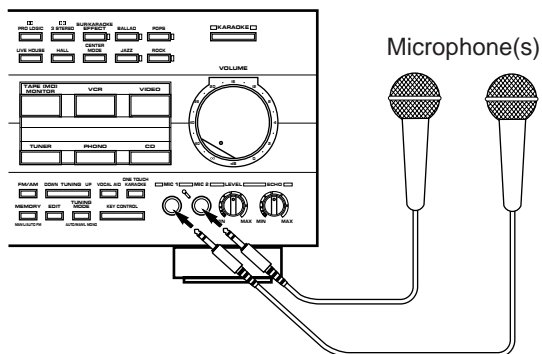

- 2** Follow steps 1 to 7 of **"BASIC OPERATIONS"** on page 19.

- 3** Select a desired DSP program for Karaoke (**BALLAD**, **POPS**, **JAZZ** or **ROCK**) or turn the DSP off (so that no DSP program is selected).

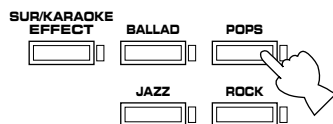

- 4** If you play a normal music source with vocals or a multisound source for Karaoke use, the **ONE TOUCH KARAOKE** button or the **VOCAL AID** button is useful for singing Karaoke. (See page 30 for details.)



- 5** Begin singing Karaoke.

- 6** According as you desire, adjust the level of sound signals input from the microphone(s), the level of echo and/or the key level of currently playing tune. (See pages 30 to 31 for details.)

**Note**

If a normal DSP program ( **PRO LOGIC**,  **3 STEREO**, **LIVE HOUSE** or **HALL**) is selected, this unit will not receive the sound signals input from the microphone(s) and no Karaoke-function of this unit (shown on pages 30 to 31) is available.

## Adjustments for enjoying Karaoke

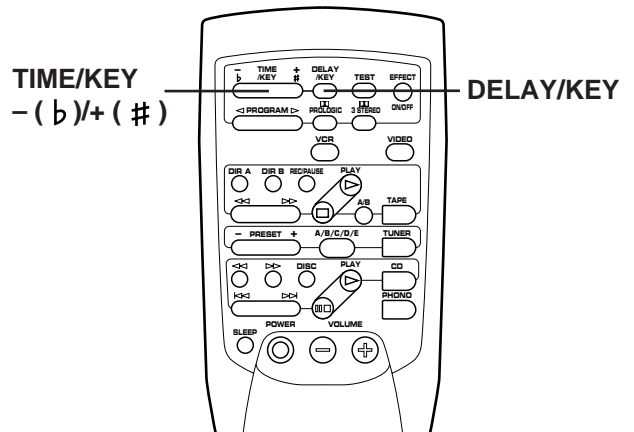
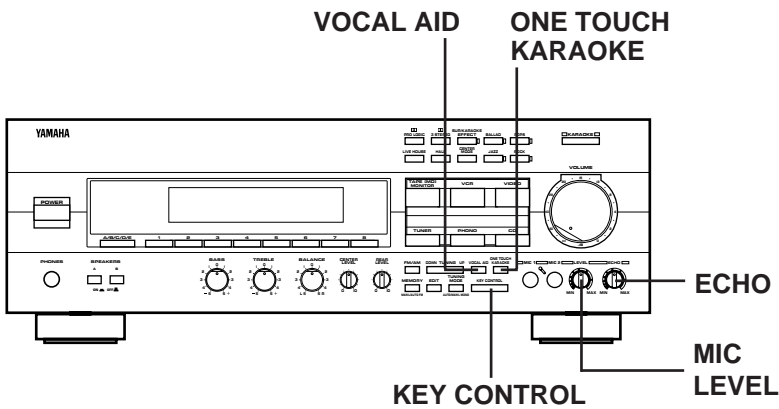

### Adjusting the level of sound signals input from the microphone(s)

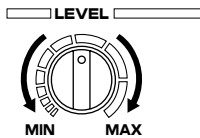

Turning the **MIC LEVEL** control clockwise increases the level, and counterclockwise decreases the level.

### Adjusting the level of echo applied to sound signals input from the microphone(s)

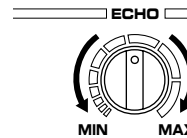

Turning the **ECHO** level control clockwise increases the level, and counterclockwise decreases the level. If you need no echo effect, set this control to the "MIN" position.

### When you sing karaoke by using a normal music source with vocals or a multisound source for Karaoke use

The following functions are useful when you sing Karaoke by using a normal music source or a multisound source for Karaoke use.



**VOCAL AID:** Press this button so that "VOCAL AID" lights up on the display. While playing a music source, only when there is an input from the microphone(s), the sound of vocals on the source is attenuated (**VOCAL CUT**). This is useful if you want to enjoy Karaoke by comparing your vocal with the original vocal.

To cancel this function, press this button once or more until "VOCAL AID" goes off from the display.

**ONE TOUCH KARAOKE:**

Press this button so that "ONE TOUCH KARAOKE" lights up on the display. The sound of vocals on the source is attenuated (**VOCAL CUT**). To cancel this function, press this button once or more until "ONE TOUCH KARAOKE" goes off from the display.

**Note:** There may be a case that vocals cannot be attenuated effectively depending on a source.

Each of these functions has the following three audio output modes. To change the mode, press the corresponding button (**VOCAL AID** or **ONE TOUCH KARAOKE**) once or more so that the name of your desired mode appears on the display.

Mode	Feature
<b>VOCAL CUT</b>	Executes the main function of each button mentioned left.
<b>MPX L ch</b>	Only signals on the left channel of the source are output from the left and right speakers. When using a karaoke source which contains both background music and original vocals on the right channel and background music only on the left channel, selecting this mode is suitable for singing karaoke.
<b>MPX R ch</b>	Only signals on the right channel of the source are output from the left and right speakers. When using a karaoke source which contains both background music and original vocals on the left channel and background music only on the right channel, selecting this mode is suitable for singing karaoke.

## Adjusting key of the tune currently playing

Pressing the **KEY CONTROL** button changes key of the tune currently playing. The current key level is shown on the display. Whenever a tune changes, its original key level is restored.

**Control range:** -6 to -1, 0, +1 to +6

**To operate on the front panel:**

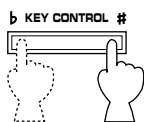

- b** (Left side) : Whenever this side is pressed, key of the tune becomes lower in 6 steps.  
**#** (Right side) : Whenever this side is pressed, key of the tune becomes higher in 6 steps.

**To operate on the remote control transmitter:**

- 1 Press once or more so that "KEY" appears on the display.

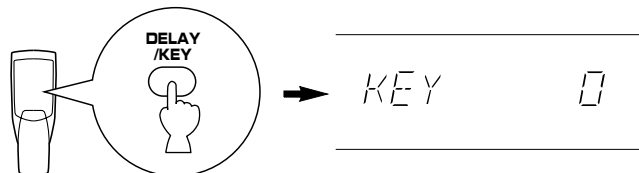

- 2 By continuously pressing the "+" or "-" side of the **TIME/KEY** button, the value changes continuously.

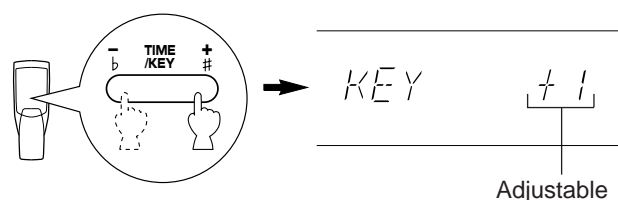

### Notes

The key level you have adjusted is automatically reset to "0" by the following operations.

- Changing the selected input source to another by pressing an input selector button.
- Turning the power to this unit off by pressing the **POWER** switch.

## Recording your vocal mixed with the source onto a tape (adding effects of a selected DSP program for Karaoke and other Karaoke functions)

Only when a DSP program for Karaoke (**BALLAD, POPS, JAZZ** or **ROCK**) is selected or the DSP is turned off (so that "E. OFF" appears on the display), you can record your vocal input from the microphone(s) connected to this unit along with the source onto a tape (or MD) by using the tape deck, VCR, etc. connected to the TAPE (MD) REC OUT and/or VCR OUT terminals on the rear of this unit.

In addition, an effect sound of the selected DSP program for Karaoke and effects of Karaoke functions (**VOCAL AID, ONE TOUCH KARAOKE, MIC LEVEL, ECHO** and/or **KEY CONTROL**) can also be recorded with the vocal and the source.

**To record:**

- 1 Select the source to be recorded by pressing the corresponding input selector button.
- 2 Prepare to sing Karaoke by using microphone(s).
- 3 If you want to record an effect sound of DSP program for Karaoke together, select the corresponding program. If you want to record effects of Karaoke functions (**VOCAL AID, ONE TOUCH KARAOKE, MIC LEVEL, ECHO** and/or **KEY CONTROL**) together, turn the corresponding functions on or make adjustments on them.

- 4 Confirm that "TAPE MON" is not illuminated on the display. If "TAPE MON" is illuminated, extinguish it by pressing the **TAPE (MD) MONITOR** button on the front panel. If "TAPE MON" is illuminated, your vocal, effect sound of the selected DSP program for Karaoke and effects of Karaoke functions cannot be recorded.
- 5 Play the source and then turn the **VOLUME** control up to confirm the input source.
- 6 Begin recording on the tape deck (or MD recorder etc.) or VCR connected to this unit.
- 7 Begin singing Karaoke.

### Notes

- An effect sound of the selected DSP program output from the main speakers can be recorded along with your vocal, however, an effect sound output from the rear speakers cannot be recorded.
- If "VCR" is selected as the input source, recording cannot be made by using the VCR etc. connected to the VCR OUT terminals on the rear of this unit.

# SETTING THE SLEEP TIMER

If you use the SLEEP timer of this unit, you can make this unit turn off automatically. When you are going to sleep while enjoying a broadcast or other desired input source, this timer function is helpful.

## Notes

- The SLEEP timer can be controlled only with the remote control transmitter.
- The components on which the SLEEP timer is effective are the sources connected to the **SWITCHED AC OUTLETS** on the rear panel of this unit.

## To set the SLEEP time

1

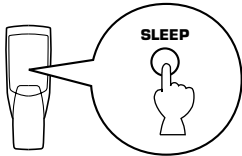

Press once or more to select the desired SLEEP time.



Indicates the SLEEP time.



Lights up.

Whenever the **SLEEP** key is pressed, the SLEEP time will change as follows.

(Minutes)

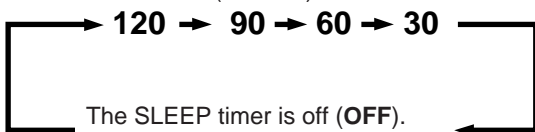

The SLEEP timer is off (**OFF**).  
(The state before the **SLEEP** key is pressed.)

After a while, the display returns to the indication before the SLEEP timer is set.

2 The unit will be turned off automatically at the selected SLEEP time.

## To cancel the selected SLEEP time

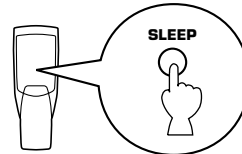

Press once or more so that "SLEEP OFF" appears on the display. (It will soon disappear and the "SLEEP" indicator will go off from the display.)

## Note

The SLEEP timer setting can also be canceled by turning off the power with the **POWER** switch or disconnecting the power plug of this unit from the AC outlet.



# TROUBLESHOOTING

If the unit fails to operate normally, check the following points to determine whether the fault can be corrected by the simple measures suggested. If it cannot be corrected, or if the fault is not listed in the SYMPTOM column, disconnect the power cord and contact your authorized YAMAHA dealer or service center for help.

	SYMPTOM	CAUSE	REMEDY
General	The unit fails to turn on when the POWER switch is pressed, or turns off suddenly soon after the power is turned on.	Power cord is not plugged in or is not completely inserted.	Firmly plug in the power cord.
		The IMPEDANCE SELECTOR switch on the rear panel is not set to the upper or the lower end exactly.	Set the switch to the upper or the lower end exactly.
	It happens that this unit does not work normally.	There is an influence of strong external noise (lightning, excessive static electricity, etc.) or a misoperation on this unit while using this unit.	Turn off the power to this unit and disconnect the AC power cord from the AC outlet. After about 30 seconds have passed, connect the power and operate this unit again.
	No sound or no picture.	Incorrect output cord connections.	Connect the cords properly. If the problem persists, the cords may be defective.
		Appropriate input source is not selected.	Select an appropriate input source with the input selector buttons.
		The SPEAKERS switches are not set properly.	Set the SPEAKERS switch which corresponds to the speakers to be used to the ON position.
		Speaker connections are not secure.	Secure the connections.
	The sound suddenly goes off.	The protection circuit has been activated because of short circuit etc.	Turning the unit off and then on will reset the protection circuit.
		The SLEEP timer has functioned.	Cancel the SLEEP timer function.
	Only one side speaker outputs the sound.	Incorrect setting of the BALANCE control.	Adjust it to the appropriate position.
		Incorrect cord connections.	Connect the cords properly. If the problem persists, the cords may be defective.
	Sound "hums".	Incorrect cord connections.	Firmly connect the audio plugs. If the problem persists, the cords may be defective.
		No connection from the turntable to the GND terminal.	Make the GND connection between the turntable and this unit.
	The volume level is low while playing a record.	The record is being played on a turntable with an MC cartridge.	The player should be connected to the unit through the MC head amplifier.
	The volume level cannot be increased, or sound is distorted.	The power to the component connected to the REC OUT terminals of this unit is off.	Turn the power to the component on.
	No sound from the rear speakers.	The sound output level to the rear speakers is set to minimum.	Raise the sound output level to the rear speakers.
		Incorrect sound field program selection.	Select the appropriate program.
	No sound from the center speaker.	The sound output level to the center speaker is set to minimum.	Raise the sound output level to the center speaker.
The center channel mode is in PHANTOM mode.		Select NORMAL or WIDE.	
Incorrect sound field program selection.		Select the appropriate program.	
The sound is degraded when listening with the headphones connected to the compact disc player or cassette deck that are connected with this unit.	The power to this unit is off.	Turn the power to this unit on.	
FM	FM stereo reception is noisy.	Because of the characteristics of FM stereo broadcasts, this is limited to cases where the transmitter is too far away or the antenna input is poor.	Check the antenna connections. Try using a high quality directional FM antenna. Set the TUNING MODE button to the manual tuning mode.
	There is distortion and clear reception cannot be obtained even with a good FM antenna.	There is multipath interference.	Adjust antenna placement to eliminate multipath interference.
	A desired station cannot be tuned in with the automatic tuning method.	The station is too weak.	Use the manual tuning method. Use a high quality directional FM antenna.
	Previously preset stations can no longer be tuned in.	This unit has been unplugged for a long period.	Repeat the presetting procedure.
AM	A desired station cannot be tuned in with the automatic tuning method.	Weak signal or loose antenna connections.	Tighten the AM loop antenna connections and rotate it for best reception. Use the manual tuning method.
	There are continuous crackling and hissing noises.	Noises will result from lightning, fluorescent lamps, motors, thermostats and other electrical equipment.	Use an outdoor antenna and a ground wire. This will help somewhat but it is difficult to eliminate all noise.
	There are buzzing and whining noises (especially in the evening).	A television set is being used nearby.	Relocate this unit away from the TV.
Remote control transmitter	The remote control transmitter does not work.	Direct sunlight or lighting (of an inverter type of fluorescent lamp etc.) is striking the remote control sensor of the main unit.	Change the position of the main unit.
		The batteries of this remote control transmitter are too weak.	Replace the batteries with new ones.

# SPECIFICATIONS

## AUDIO SECTION

Minimum RMS Output Power per Channel

Main L, R  
8 ohms, 20 Hz to 20 kHz, 0.04% THD  
[U.S.A. model].....60W + 60W  
[Singapore and General models]  
.....55W + 55W

Center  
8 ohms, 1 kHz, 0.1% THD  
[U.S.A. model] .....60W  
[Singapore and General models].....55W

Rear  
8 ohms, 1 kHz, 0.7% THD .....20W

Maximum Power [General model only]  
(8 ohms, 1 kHz, 10% THD)  
Main L, R .....85W + 85W  
Center .....85W  
Rear .....35W

Dynamic Power per Channel  
(by IHF Dynamic Headroom measuring  
method)  
8/6/4/2 ohms .....80/100/120/140W

Power Band Width  
8 ohms, 30W, 0.1% THD  
.....10 Hz to 50 kHz

Damping Factor (SPEAKERS A)  
8 ohms, 20 Hz to 20 kHz .....80 or more

Input Sensitivity/Impedance  
PHONO MM .....2.5 mV/47 k-ohms  
CD/TAPE (MD)/VIDEO/VCR  
.....150 mV/47 k-ohms  
MIC 1, 2.....450  $\mu$ V/32 k-ohms

Maximum Input Signal  
PHONO MM  
1 kHz, 0.04% THD.....90 mV  
MIC 1, 2  
1 kHz, 0.1% THD.....30 mV

Headphone Jack Rated Output/Impedance  
Output Level (8 ohms, 0.04% THD).....0.49V  
Impedance.....330 ohms

Frequency Response (20 Hz to 20 kHz)  
CD/TAPE (MD)/VIDEO/VCR  
.....0 $\pm$ 0.5 dB

RIAA Equalization Deviation  
PHONO MM.....0 $\pm$ 0.5 dB

Total Harmonic Distortion (20 Hz to 20 kHz)  
PHONO MM to REC OUT  
1V .....0.02%  
CD/TAPE (MD)/VIDEO/VCR to SP OUT  
30W/8 ohms .....0.02%

Signal-to-Noise Ratio (IHF-A Network)  
PHONO MM to REC OUT  
(5 mV Input Shorted) .....82 dB  
CD/TAPE (MD)/VIDEO/VCR to SP OUT  
(Shorted) .....93 dB

Residual Noise (IHF-A Network)  
MAIN L/R .....140  $\mu$ V

Channel Separation  
(Vol. -30 dB, EFFECT OFF)  
PHONO MM  
(Input Shorted, 1 kHz) .....60 dB  
CD/TAPE (MD)/VIDEO/VCR  
(Input 5.1 k-ohms Terminated,  
1 kHz) .....60 dB

Tone Control Characteristics  
BASS: Boost/cut..... $\pm$ 10 dB (50 Hz)  
Turnover Frequency .....(350 Hz)  
TREBLE: Boost/cut..... $\pm$ 10 dB (20 kHz)  
Turnover Frequency.....(3.5 kHz)

Key Control Pitch..... $\pm$ 3 notes, 13 steps

Delay Time  
MIC, ECHO.....150 msec.  
BALLAD, POPS, JAZZ, ROCK  
.....1 to 50 msec.  
LIVE HOUSE, HALL .....1 to 100 msec.  
 PRO LOGIC .....15 to 30 msec.

Gain Tracking Error (0 to -60 dB) .....3 dB

## VIDEO SECTION

Video Signal Type  
[U.S.A. and General models]  
.....NTSC/PAL  
[Singapore model] .....PAL

Video Signal Level.....1 Vp-p/75 ohms

Maximum Input Level.....1.5 Vp-p or more

Signal-to-Noise Ratio .....50 dB or more

Monitor Out Frequency Response  
.....5 Hz to 10 MHz, -3 dB

## FM SECTION

Tuning Range  
[U.S.A. model] .....87.5 to 107.9 MHz  
[Singapore and General models]  
.....87.5 to 108.0 MHz

50 dB Quieting Sensitivity (IHF, 75 ohms)  
[U.S.A. and General models only]  
Mono .....1.55  $\mu$ V (15.1 dBf)  
Stereo .....21  $\mu$ V (37.7 dBf)

Usable Sensitivity (75 ohms)  
(30 dB S/N Quieting, 1 kHz, 100% mod.)  
[U.S.A. and General models]  
.....0.8  $\mu$ V (9.3 dBf)  
DIN, Mono (S/N 26 dB)  
[Singapore model] .....0.9  $\mu$ V  
DIN, Stereo (S/N 46 dB)  
[Singapore model] .....24  $\mu$ V

Image Response Ratio  
[U.S.A. and General models].....45 dB  
[Singapore model] .....80 dB

IF Response Ratio .....80 dB

Spurious Response Ratio .....70 dB

AM Suppression Ratio .....55 dB

Capture Ratio.....1.5 dB

Alternate Channel Selectivity  
[U.S.A. and General models].....85 dB

Selectivity (two signals, 40 kHz Dev.  $\pm$ 300 kHz)  
[Singapore model] .....70 dB

Signal-to-Noise Ratio  
(IHF) Mono/Stereo  
[U.S.A. and General models]  
.....80 dB/75 dB  
(DIN-Weighted, 40 kHz Dev.) Mono/Stereo  
[Singapore model] .....74 dB/69 dB

Harmonic Distortion  
Mono/Stereo (1 kHz) .....0.1/0.2%

Stereo Separation (1 kHz).....50 dB

Frequency Response  
30 Hz to 15 kHz .....0  $\pm$ 0.5 dB

**AM SECTION**

Tuning Range  
 [U.S.A. and General models] .....530 to 1,710 kHz  
 [Singapore model] .....531 to 1,611 kHz

Usable Sensitivity .....100  $\mu$ V/m

Selectivity .....32 dB

Signal-to-Noise Ratio .....50 dB

Image Response Ratio .....40 dB

Spurious Response Ratio .....50 dB

Harmonic Distortion (1 kHz) .....0.3%

**AUDIO SECTION****Output Level/Impedance**

FM (100% mod., 1 kHz)  
 [U.S.A. and General models]  
 .....500 mV/2.2 k-ohms  
 [Singapore model (40 kHz Dev.)]  
 .....400 mV/2.2 k-ohms  
 AM (30% mod., 1 kHz)  
 .....150 mV/2.2 k-ohms

**GENERAL****Power Supply**

[U.S.A. model] .....AC 120V, 60 Hz  
 [Singapore model] .....AC 230V, 50 Hz  
 [General model]  
 .....AC 110/120/220/240V, 50/60 Hz

Power Consumption .....180W

**Maximum Power Consumption**

(8 ohms, 1 kHz, 10% THD, When 5 channels  
 are driven:  
 [Singapore model only] .....500W

**AC Outlets**

2 SWITCHED OUTLETS  
 .....100W max. total

**Dimensions (W x H x D)**

.....435 x 151 x 266.5 mm  
 (17-1/8" x 5-15/16" x 10-1/2")

Weight .....7.8 kg (17 lbs. 3 oz.)

**Accessories**

.....AM loop antenna  
 Indoor FM antenna  
 Remote control transmitter  
 Batteries  
 Antenna adapter  
 (U.S.A. model only)

Specifications are subject to change without  
 notice.

# YAMAHA

---

YAMAHA ELECTRONICS CORPORATION, USA 6660 ORANGETHORPE AVE., BUENA PARK, CALIF. 90620, U.S.A.  
YAMAHA CANADA MUSIC LTD. 135 MILNER AVE., SCARBOROUGH, ONTARIO M1S 3R1, CANADA  
YAMAHA ELECTRONIK EUROPA G.m.b.H. SIEMENSSTR. 22-34, 25462 RELINGEN BEI HAMBURG, FR. OF GERMANY  
YAMAHA ELECTRONIQUE FRANCE S.A. RUE AMBROISE CROIZAT BP70 CROISSY-BEAUBOURG 77312 MARNE-LA-VALLEE CEDEX02, FRANCE  
YAMAHA ELECTRONICS (UK) LTD. YAMAHA HOUSE, 200 RICKMANSWORTH ROAD WATFORD, HERTS WD1 7JS, ENGLAND  
YAMAHA SCANDINAVIA A.B. J A WETTERGRENS GATA 1, BOX 30053, 400 43 VÄSTRA FRÖLUNDA, SWEDEN  
YAMAHA MUSIC AUSTRALIA PTY, LTD. 17-33 MARKET ST., SOUTH MELBOURNE, 3205 VIC., AUSTRALIA

YAMAHA CORPORATION  
VY88920