



DIGITAL WORKSTATION

PSR-S650

Owner's Manual

Before using the instrument, be sure to read "PRECAUTIONS" on pages 4-5.



EN

SPECIAL MESSAGE SECTION

This product utilizes batteries or an external power supply (adapter). DO NOT connect this product to any power supply or adapter other than one described in the manual, on the name plate, or specifically recommended by Yamaha.

WARNING: Do not place this product in a position where anyone could walk on, trip over, or roll anything over power or connecting cords of any kind. The use of an extension cord is not recommended! If you must use an extension cord, the minimum wire size for a 25' cord (or less) is 18 AWG. NOTE: The smaller the AWG number, the larger the current handling capacity. For longer extension cords, consult a local electrician.

This product should be used only with the components supplied or; a cart, rack, or stand that is recommended by Yamaha. If a cart, etc., is used, please observe all safety markings and instructions that accompany the accessory product.

SPECIFICATIONS SUBJECT TO CHANGE:

The information contained in this manual is believed to be correct at the time of printing. However, Yamaha reserves the right to change or modify any of the specifications without notice or obligation to update existing units.

This product, either alone or in combination with an amplifier and headphones or speaker/s, may be capable of producing sound levels that could cause permanent hearing loss. DO NOT operate for long periods of time at a high volume level or at a level that is uncomfortable. If you experience any hearing loss or ringing in the ears, you should consult an audiologist.

IMPORTANT: The louder the sound, the shorter the time period before damage occurs.

Some Yamaha products may have benches and / or accessory mounting fixtures that are either supplied with the product or as optional accessories. Some of these items are designed to be dealer assembled or installed. Please make sure that benches are stable and any optional fixtures (where applicable) are well secured BEFORE using.

Benches supplied by Yamaha are designed for seating only. No other uses are recommended.

NOTICE:

Service charges incurred due to a lack of knowledge relating to how a function or effect works (when the unit is operating as designed) are not covered by the manufacturer's warranty, and are therefore the owners responsibility. Please study this manual carefully and consult your dealer before requesting service.

ENVIRONMENTAL ISSUES:

Yamaha strives to produce products that are both user safe and environmentally friendly. We sincerely believe that our products and the production methods used to produce them, meet these goals. In keeping with both the letter and the spirit of the law, we want you to be aware of the following:

Battery Notice:

This product MAY contain a small non-rechargeable battery which (if applicable) is soldered in place. The average life span of this type of battery is approximately five years. When replacement becomes necessary, contact a qualified service representative to perform the replacement.

This product may also use "household" type batteries. Some of these may be rechargeable. Make sure that the battery being charged is a rechargeable type and that the charger is intended for the battery being charged.

When installing batteries, never mix old batteries with new ones, and never mix different types of batteries. Batteries MUST be installed correctly. Mismatches or incorrect installation may result in overheating and battery case rupture.

Warning:

Do not attempt to disassemble, or incinerate any battery. Keep all batteries away from children. Dispose of used batteries promptly and as regulated by the laws in your area. Note: Check with any retailer of household type batteries in your area for battery disposal information.

Disposal Notice:

Should this product become damaged beyond repair, or for some reason its useful life is considered to be at an end, please observe all local, state, and federal regulations that relate to the disposal of products that contain lead, batteries, plastics, etc. If your dealer is unable to assist you, please contact Yamaha directly.

NAME PLATE LOCATION:

The name plate is located on the bottom of the product. The model number, serial number, power requirements, etc., are located on this plate. You should record the model number, serial number, and the date of purchase in the spaces provided below and retain this manual as a permanent record of your purchase.

Model

Serial No.

Purchase Date

PLEASE KEEP THIS MANUAL

92-BP (bottom)

FCC INFORMATION (U.S.A.)

1. IMPORTANT NOTICE: DO NOT MODIFY THIS UNIT!

This product, when installed as indicated in the instructions contained in this manual, meets FCC requirements. Modifications not expressly approved by Yamaha may void your authority, granted by the FCC, to use the product.

2. IMPORTANT: When connecting this product to accessories and/or another product use only high quality shielded cables. Cable/s supplied with this product MUST be used. Follow all installation instructions. Failure to follow instructions could void your FCC authorization to use this product in the USA.

3. NOTE: This product has been tested and found to comply with the requirements listed in FCC Regulations, Part 15 for Class "B" digital devices. Compliance with these requirements provides a reasonable level of assurance that your use of this product in a residential environment will not result in harmful interference with other electronic devices. This equipment generates/uses radio frequencies and, if not installed and used according to the instructions found in the users manual, may cause interference harmful to the operation of other electronic devices. Compliance with FCC regulations does

not guarantee that interference will not occur in all installations. If this product is found to be the source of interference, which can be determined by turning the unit "OFF" and "ON", please try to eliminate the problem by using one of the following measures:

Relocate either this product or the device that is being affected by the interference.

Utilize power outlets that are on different branch (circuit breaker or fuse) circuits or install AC line filter/s.

In the case of radio or TV interference, relocate/reorient the antenna. If the antenna lead-in is 300 ohm ribbon lead, change the lead-in to co-axial type cable.

If these corrective measures do not produce satisfactory results, please contact the local retailer authorized to distribute this type of product. If you can not locate the appropriate retailer, please contact Yamaha Corporation of America, Electronic Service Division, 6600 Orangethorpe Ave, Buena Park, CA90620

The above statements apply ONLY to those products distributed by Yamaha Corporation of America or its subsidiaries.

**COMPLIANCE INFORMATION STATEMENT
(DECLARATION OF CONFORMITY PROCEDURE)**

Responsible Party : Yamaha Corporation of America
Address : 6600 Orangethorpe Ave., Buena Park,
Calif. 90620
Telephone : 714-522-9011
Type of Equipment : Digital Keyboard
Model Name : PSR-S650

This device complies with Part 15 of the FCC Rules.

Operation is subject to the following two conditions:

- 1) this device may not cause harmful interference, and
- 2) this device must accept any interference received including interference that may cause undesired operation.

See user manual instructions if interference to radio reception is suspected.

* This applies only to products distributed by
YAMAHA CORPORATION OF AMERICA.

(FCC DoC)

PRECAUTIONS

PLEASE READ CAREFULLY BEFORE PROCEEDING

* Please keep this manual in a safe place for future reference.



WARNING

Always follow the basic precautions listed below to avoid the possibility of serious injury or even death from electrical shock, short-circuiting, damages, fire or other hazards. These precautions include, but are not limited to, the following:

Power supply/AC power adaptor

- Do not place the power cord near heat sources such as heaters or radiators, and do not excessively bend or otherwise damage the cord, place heavy objects on it, or place it in a position where anyone could walk on, trip over, or roll anything over it.
- Only use the voltage specified as correct for the instrument. The required voltage is printed on the name plate of the instrument.
- Use the specified adaptor (page 70) only. Using the wrong adaptor can result in damage to the instrument or overheating.
- Check the electric plug periodically and remove any dirt or dust which may have accumulated on it.

Do not open

- This instrument contains no user-serviceable parts. Do not open the instrument or attempt to disassemble or modify the internal components in any way. If it should appear to be malfunctioning, discontinue use immediately and have it inspected by qualified Yamaha service personnel.

Water warning

- Do not expose the instrument to rain, use it near water or in damp or wet conditions, place on it any containers (such as vases, bottles or glasses) containing liquids which might spill into any openings. If any liquid such as water seeps into the instrument, turn off the power immediately and unplug the power cord from the AC outlet. Then have the instrument inspected by qualified Yamaha service personnel.
- Never insert or remove an electric plug with wet hands.

Fire warning

- Do not put burning items, such as candles, on the unit. A burning item may fall over and cause a fire.

If you notice any abnormality

- When one of the following problems occur, immediately turn off the power switch and disconnect the electric plug from the outlet. Then have the device inspected by Yamaha service personnel.
 - The power cord or plug becomes frayed or damaged.
 - It emits unusual smells or smoke.
 - Some object has been dropped into the instrument.
 - There is a sudden loss of sound during use of the instrument.



CAUTION

Always follow the basic precautions listed below to avoid the possibility of physical injury to you or others, or damage to the instrument or other property. These precautions include, but are not limited to, the following:

Power supply/AC power adaptor

- Do not connect the instrument to an electrical outlet using a multiple-connector. Doing so can result in lower sound quality, or possibly cause overheating in the outlet.
- When removing the electric plug from the instrument or an outlet, always hold the plug itself and not the cord. Pulling by the cord can damage it.
- Remove the electric plug from the outlet when the instrument is not to be used for extended periods of time, or during electrical storms.

Location

- Do not place the instrument in an unstable position where it might accidentally fall over.
- Before moving the instrument, remove all connected cables.
- When setting up the product, make sure that the AC outlet you are using is easily accessible. If some trouble or malfunction occurs, immediately turn off the power switch and disconnect the plug from the outlet. Even when the power switch is turned off, electricity is still flowing to the product at the minimum level. When you are not using the product for a long time, make sure to unplug the power cord from the wall AC outlet.

Connections

- Before connecting the instrument to other electronic components, turn off the power for all components. Before turning the power on or off for all components, set all volume levels to minimum.
- Be sure to set the volumes of all components at their minimum levels and gradually raise the volume controls while playing the instrument to set the desired listening level.

Handling caution

- Do not insert a finger or hand in any gaps on the instrument.
- Never insert or drop paper, metallic, or other objects into the gaps on the panel or keyboard. This could cause physical injury to you or others, damage to the instrument or other property, or operational failure.
- Do not rest your weight on, or place heavy objects on the instrument, and do not use excessive force on the buttons, switches or connectors.
- Do not use the instrument/device or headphones for a long period of time at a high or uncomfortable volume level, since this can cause permanent hearing loss. If you experience any hearing loss or ringing in the ears, consult a physician.

Yamaha cannot be held responsible for damage caused by improper use or modifications to the instrument, or data that is lost or destroyed.

Always turn the power off when the instrument is not in use.

Even when the power switch is in standby status, electricity is still flowing to the instrument at the minimum level. When you are not using the instrument for a long time, make sure you unplug the power cord from the wall AC outlet.

NOTICE

To avoid the possibility of malfunction/ damage to the product, damage to data, or damage to other property, follow the notices below.

■ **Handling and Maintenance**

- Do not use the instrument in the vicinity of a TV, radio, stereo equipment, mobile phone, or other electric devices. Otherwise, the instrument, TV, or radio may generate noise.
- Do not expose the instrument to excessive dust or vibrations, or extreme cold or heat (such as in direct sunlight, near a heater, or in a car during the day) to prevent the possibility of panel disfiguration, damage to the internal components or unstable operation. (Verified operating temperature range: 5° – 40°C, or 41° – 104°F.)
- Do not place vinyl, plastic or rubber objects on the instrument, since this might discolor the panel or keyboard.
- When cleaning the instrument, use a soft, cloth. Do not use paint thinners, solvents, cleaning fluids, or chemical-impregnated wiping cloths.

■ **Saving data**

- Some data items (page 53) are automatically saved as backup data in the internal memory even if you turn the power off. Saved data may be lost due to malfunction or incorrect operation. Save important data to a USB flash memory (pages 57–58) or a computer (refer to the Reference Manual.) To protect against data loss through media damage, we recommend that you save your important data onto two USB storage devices/external media.

Information

■ **About copyrights**

- Copying of the commercially available musical data including but not limited to MIDI data and/or audio data is strictly prohibited except for your personal use.
- This product incorporates and bundles computer programs and contents in which Yamaha owns copyrights or with respect to which it has license to use others' copyrights. Such copyrighted materials include, without limitation, all computer software, style files, MIDI files, WAVE data, musical scores and sound recordings. Any unauthorized use of such programs and contents outside of personal use is not permitted under relevant laws. Any violation of copyright has legal consequences. **DON'T MAKE, DISTRIBUTE OR USE ILLEGAL COPIES.**

■ **About functions/data bundled with the instrument**

- Some of the preset songs have been edited for length or arrangement, and may not be exactly the same as the original.
- This device is capable of using various types/formats of music data by optimizing them to the proper format music data for use with the device in advance. As a result, this device may not play them back precisely as their producers or composers originally intended.

■ **About this manual**

- The illustrations and displays as shown in this manual are for instructional purposes only, and may appear somewhat different from those on your instrument.
- Windows is a registered trademark of Microsoft® Corporation in the United States and other countries.
- Apple, Mac and Macintosh are trademarks of Apple Inc., registered in the U.S. and other countries.
- The bitmap fonts used in this instrument have been provided by and are the property of Ricoh Co., Ltd.
- The company names and product names in this manual are the trademarks or registered trademarks of their respective companies.

Supplied Accessories

- Owner's Manual (this book)
- Data List
- AC power adaptor
 - * May not be included depending on your particular area. Please check with your Yamaha dealer.
- My Yamaha Product User Registration
 - * The PRODUCT ID on the sheet will be needed when you fill out the User Registration form.
- Music rest

Formats

The instrument is compatible with the following formats.



GM System Level 2

“GM (General MIDI)” is one of the most common Voice allocation formats. “GM System Level 2” is a standard specification that enhances the original “GM” and improves Song data compatibility.



XG

XG is a major enhancement of the GM System Level 1 format, and was developed by Yamaha specifically to provide more Voices and variations, as well as greater expressive control over Voices and effects, and to ensure compatibility of data well into the future.



GS

GS was developed by the Roland Corporation. In the same way as Yamaha XG, GS is a major enhancement of the GM specifically to provide more Voices and Drum kits and their variations, as well as greater expressive control over Voices and effects.



XF

The Yamaha XF format enhances the SMF (Standard MIDI File) standard with greater functionality and open-ended expandability for the future. This instrument is capable of displaying lyrics when an XF file containing lyric data is played.



SFF GE (Guitar Edition)

“SFF (Style File Format)” is an original Style file format by Yamaha which uses a unique conversion system to provide high-quality automatic accompaniment based on a wide range of chord types. “SFF GE (Guitar Edition)” is an enhanced format of SFF, which features improved note transposition for guitar tracks.



USB

USB is an abbreviation for Universal Serial Bus. It is a serial interface for connecting a computer with peripheral Devices. It allows “hot swapping” (connecting peripheral devices while the power to the computer is on).

About the Manuals

■ Included Documents



Owner’s Manual (this book)

Provides overall explanations of the PSR-S650 basic functions. In this Owner’s Manual, the “Contents” on page 7, the “Panel Controls and Terminals” on page 8, and the “Panel Button Chart” on page 65 should be used when you are searching for a specific function or information. The “Contents” lists basic functions of the instrument, the “Panel Controls and Terminals” provides summary about the panel controls and connectors, and the “Panel Button Chart” lists all the displays called up from the panel controls. Use one of the methods described above to find the information you are looking for.



Data List

Contains various important preset content lists such as Voices, Styles and Effects.

■ Online Materials (Downloadable from the web)

The following instructional materials are available for downloading from the Yamaha Manual Library. Access the Yamaha Manual Library, then enter your model name (PSR-S650, for example) in the Model Name area to search the manuals.

Yamaha Manual Library <http://www.yamaha.co.jp/manual/>



Reference Manual (Only in English, German, French, Spanish, Portuguese, Russian, Chinese and Japanese)

Explains advanced features of the PSR-S650. After reading the Owner’s Manual and you want more detailed information about PSR-S650 features, refer to the Reference Manual. To check which manual, Owner’s or Reference, contains descriptions of the desired function, refer to the Panel Button Chart on page 65.



MIDI Reference (Only in English)

Contains both the MIDI Data Format and the MIDI Implementation Chart, which allows you to confirm MIDI messages transmitted/recognized by this instrument.

Contents

Supplied Accessories.....	5
Formats.....	6
About the Manuals.....	6
Panel Controls and Terminals	8
Setting Up	10
Power Requirements.....	10
Auto Power Off Function.....	10
Connecting a Footswitch.....	10
Connecting Headphones and External Audio Equipment.....	11
Turning the Power On.....	11
Changing the Display Language.....	12
Adjusting the Display CONTRAST control.....	12
Displays and Basic Operation.....	13
1 Voices – Playing the Keyboard –	16
Select and Play a Main Voice.....	16
Playing Two Voices Simultaneously.....	17
Splitting the Keyboard and Playing the Left Voice with the Left Hand.....	17
Playing Drum Kits.....	18
Applying Effects to a Voice.....	19
Changing the Pitch of the Instrument.....	20
Scale Tuning.....	22
Touch Response ON/OFF.....	26
Using the Metronome.....	27
2 Styles	29
– Playing Rhythm and Accompaniment –	29
Select and Play a Style.....	29
Changing the Tempo.....	34
One Touch Setting.....	34
3 Using Songs	35
Selecting and Listening to a Song.....	35
Changing the Tempo.....	36
Fast Forward, Fast Reverse, and Pause.....	36
Listening to the Demo Song.....	37
Select and Play a Song from USB Flash Memory ...	37
Displaying the Song Score.....	38
Displaying the Lyrics.....	38
A-B Repeat.....	39
4 Recording Your Own Performance	40
Quick Recording Procedure.....	40
Multi-track Recording Procedure.....	41
Song Clear—Deleting User Songs.....	44
Track Clear—Deleting a Specified Track From a User Song.....	45
5 Playing with the Music Database	46
6 Mixer	47
7 Memorizing Your Favorite Panel Settings	49
Memorizing the Panel Settings.....	50
Recalling the Memorized Panel Settings.....	50
Registration Clear—Deleting the Specified Registration Memory.....	52
8 Initialization	53
Backup Data and Memory Data.....	53
Initialization.....	53
9 Using USB Flash Memory	54
File Control Display.....	55
Formatting USB Flash Memory.....	56
Saving the Registration Memory.....	57
Saving a User Song or User Style.....	58
Loading a File.....	59
Deleting Data from USB Flash Memory.....	60
10 Expanding Voices and Styles (Installing to the Expansion Category)	61
11 Connecting to a Computer	63
Appendix	64
Troubleshooting.....	64
Panel Button Chart.....	65
Messages.....	67
Specifications.....	69
Index.....	71

The other functions such as the following ones are described in the Reference Manual.

- **Style Creator**
- **Song Edit**
- **Style related functions:**
 - Style Volume, Track Mute
- **Song related functions:**
 - Song Volume, Track Mute, Right-Part, Left-part
- **MIDI related functions:**
 - PC Mode, Local, External Clock, Keyboard Out, Style Out, Song Out, Initial Setup

Panel Controls and Terminals

Front Panel

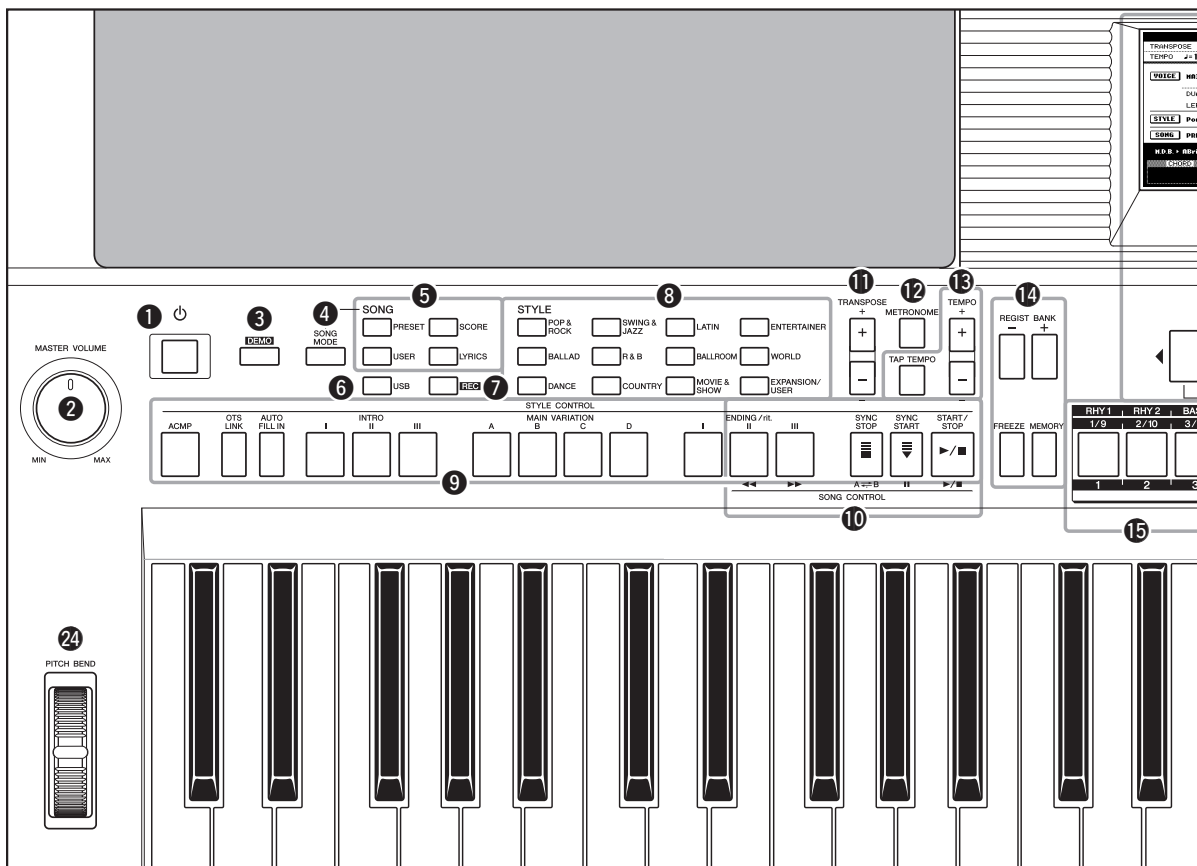

Front Panel

- 1** [] (Standby/On) switch page 11
Turns the instrument's power on or Standby.
- 2** MASTER VOLUME control page 11
Adjusts the overall volume.
- 3** [DEMO] buttonpage 37
Plays the Demo.
- 4** [SONG MODE] buttonpage 35
Switches between Song mode and Style mode.
- 5** SONG buttonspage 35
Selects a Song or show music score and lyrics.
- 6** [USB] buttonpage 35
Selects a Song or Style file in the USB flash memory.
- 7** [REC] buttonpage 40
Records your keyboard performance.
- 8** STYLE category selection buttonspage 29
Selects a Style.
- 9** STYLE CONTROL buttons pages 30–31
Controls Style playback.
- 10** SONG CONTROL buttons page 36
Controls Song playback.
- 11** TRANPOSE buttons page 20
Transposes the pitch in semitone steps.
- 12** METRONOME button page 27
Plays the Metronome.
- 13** TEMPO buttons page 34
Controls the tempo for Style, Song and Metronome playback.
- 14** REGISTRATION MEMORY-related buttons page 49
Lets you execute the function such as changing a Bank and memorizing the panel settings.
- 15** REGISTRATION MEMORY/Track buttons pages 42, 49
Pressing the [REGIST/PART[MIXER]] button at right will alternate the function of the white eight buttons: Registration Memory buttons, Song track setting buttons and Style track setting buttons.
- 16** Display and related controls pages 13–14

NOTE

The panel controls 1–24 call up the related displays, all of which are listed in the Panel Button Chart on page 65.

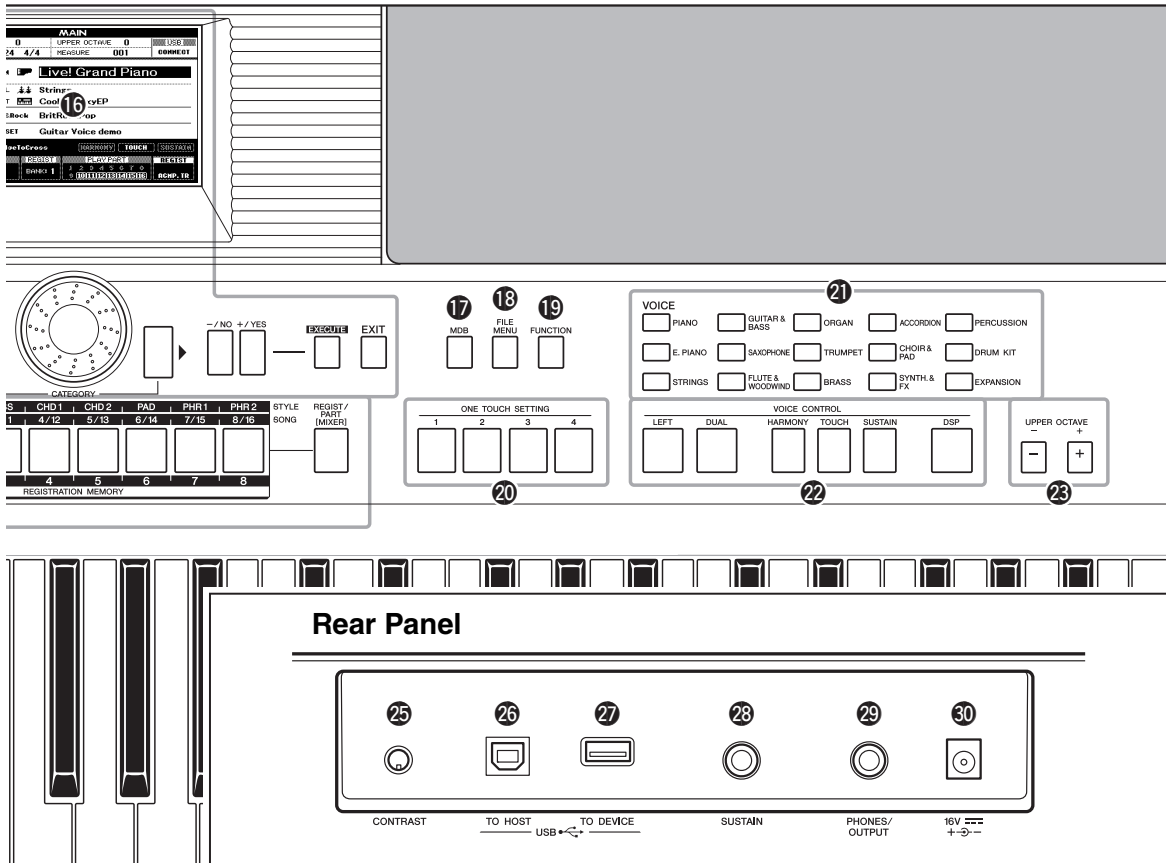

Rear Panel

Rear Panel

- 17 **[MDB] button**page 46
Calls up the appropriate panel settings for the desired music genre.
- 18 **[FILE MENU] button**page 55
Executes file operations such as loading and saving.
- 19 **[FUNCTION] button**page 15
Allows you to make the detailed settings.
- 20 **ONE TOUCH SETTING buttons**page 34
Calls up the appropriate panel settings for the current Style.
- 21 **VOICE category selection buttons**page 16
Selects a Voice.
- 22 **VOICE CONTROL buttons**page 19
Applies some effects to the keyboard performance.
- 23 **UPPER OCTAVE buttons**page 20
Shifts the pitch of the keyboard in octave steps.
- 24 **PITCH BEND wheel**page 20
Bends the pitch of the keyboard played sound up or down.

- 25 **CONTRAST knob** page 12
Adjusts the contrast of the display.
- 26 **USB TO HOST terminal** page 63
For connecting to a computer.
- 27 **USB TO DEVICE terminal** page 54
For connecting a USB storage device.
- 28 **SUSTAIN jack** page 10
For connecting a footswitch.
- 29 **PHONES/OUTPUT jack** page 11
For connecting headphones, or a powered speaker.
- 30 **DC IN jack** page 10
For connecting the power adaptor.

Setting Up

Be sure to do the following operations **BEFORE** turning on the power.

Power Requirements

⚠ WARNING

- Use the specified adaptor (page 70). The use of other adaptors may result in irreparable damage to both the adaptor and the instrument.

- 1 Connect one end of the AC cable to the power adaptor.

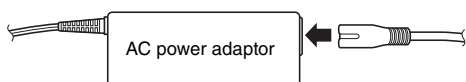

- 2 Connect the power adaptor's DC plug into the DC IN jack on the instrument's rear panel.
- 3 Plug the AC adaptor into an AC outlet.

⚠ CAUTION

- Unplug the AC Power Adaptor when not using the instrument, or during electrical storms.

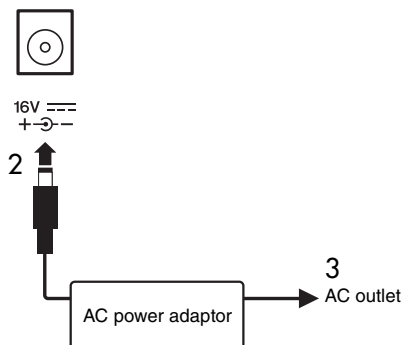

Make all necessary connections below **BEFORE** turning the power on.

Auto Power Off Function

To prevent unnecessary power consumption, this instrument features an Auto Power Off function that automatically turns the power off if the instrument is not operated for a specified period of time. The amount of time that will elapse before the power is automatically turned off is set by default to 30 minutes. To disable the Auto Power Off function, turn off the power, then press the [⏻] (Standby/On) switch to turn on the power while holding down the lowest key.

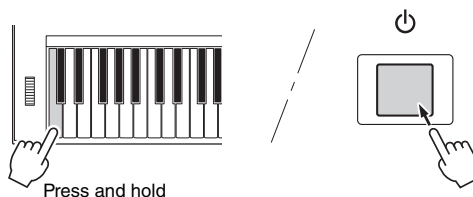

NOTE

- The setting time range can be changed in the Function display. For details, refer to the Reference Manual.

NOTE

- The data and settings are always backed up, and are maintained even when the power is turned off. For information on the backup parameters, see page 53.

Connecting a Footswitch

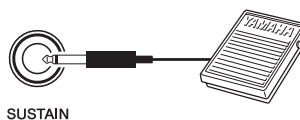

The sustain function lets you produce a natural sustain as you play by pressing an optional footswitch. Plug a Yamaha FC4 or FC5 Footswitch into the SUSTAIN jack and use it to switch sustain on and off.

NOTE

- Make sure that the footswitch plug is properly connected to the SUSTAIN jack before turning on the power.
- Do not press the footswitch while turning the power on. Doing this changes the recognized polarity of the footswitch, resulting in reversed footswitch operation.

Connecting Headphones and External Audio Equipment

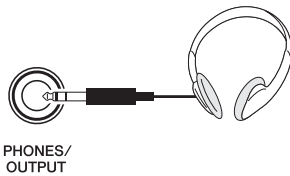

You can connect the PHONES/OUTPUT jack to a set of headphones, keyboard amplifier, stereo system, powered speaker, tape recorder, or other line-level audio device to send the instrument's output signal to that device.

The internal speakers are automatically shut off when a plug is inserted into this jack. The PHONES/OUTPUT jack also functions as an external output.

NOTE

- You can set the Master equalizer (EQ) which is provided to give you the best possible sound when listening through different reproduction systems. The Master equalizer (EQ) can be set in the Function display. For details, refer to the Reference Manual.

CAUTION

- Avoid listening with the headphones at high volume for long periods of time; doing so may not only result in ear fatigue, it may be damaging to your hearing.

CAUTION

- To prevent damage to the speakers, set the volume of the external devices at the minimum setting and turn power off the devices before connecting them. Failure to observe these precautions may result in electric shock or equipment damage. Also, be sure to set the volumes of all devices at their minimum levels and gradually raise the volume controls while playing the instrument to set the desired listening level.

Turning the Power On

Turn down the volume by turning the MASTER VOLUME control to the left and press the [⏻] (Standby/On) switch to turn on the power. While playing the keyboard, adjust the volume level by using the MASTER VOLUME control. Press the [⏻] (Standby/On) switch again for a second to turn the power to standby.

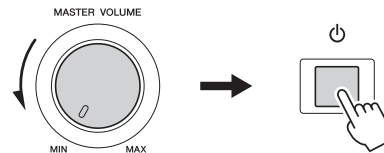

CAUTION

- When using a power adaptor, even when the power is off, a small amount of electricity is still being consumed by the instrument. When you are not using the instrument for a long time, make sure to unplug the AC power adaptor from the wall AC outlet.

NOTICE

- Never attempt to turn the power off when a "Writing.." message is shown in the display. Doing so can damage the data on the flash memory and result in a loss of data.

Changing the Display Language

This instrument allows you to select English or Japanese as the display language. The default display language is English, but if you switch to Japanese the lyrics, file names and some messages will be displayed in Japanese where appropriate.

- 1 Press the [FUNCTION] button.

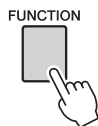

- 2 Press the CATEGORY [◀] and [▶] buttons repeatedly until the “Language” item appears. The currently selected display language will appear below the “Language” item.

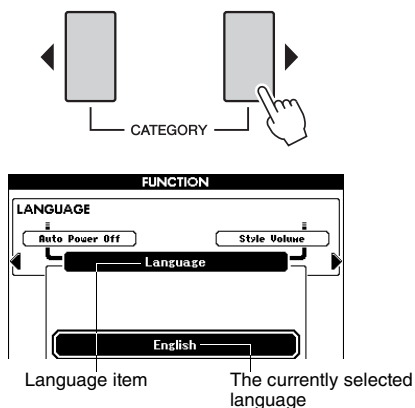

- 3 Select a display language. Using dial to select English or Japanese. The language selection will be stored in the internal flash memory so that it is retained even when the power is turned off.

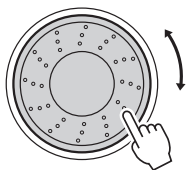

- 4 Press the [EXIT] button to return to the Main display.

Adjusting the Display CONTRAST control

Adjust the display CONTRAST control on the rear panel of the instrument for optimum display legibility.

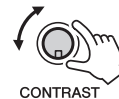

CAUTION

- Looking at the display for a long period of time in the dark may cause eyestrain or damage to your eyesight. Make sure to use the instrument with as much ambient light as possible and also take adequate breaks and rest from use.

Music Rest

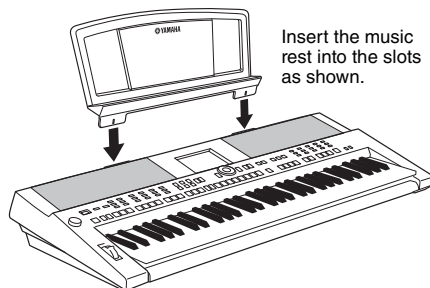

Displays and Basic Operation

Main Display

The Main display, called up when the power is turned on, shows all of the current basic settings: Song, Style, Voice.

It also includes a range of indicators that show the on/off status of a range of functions.

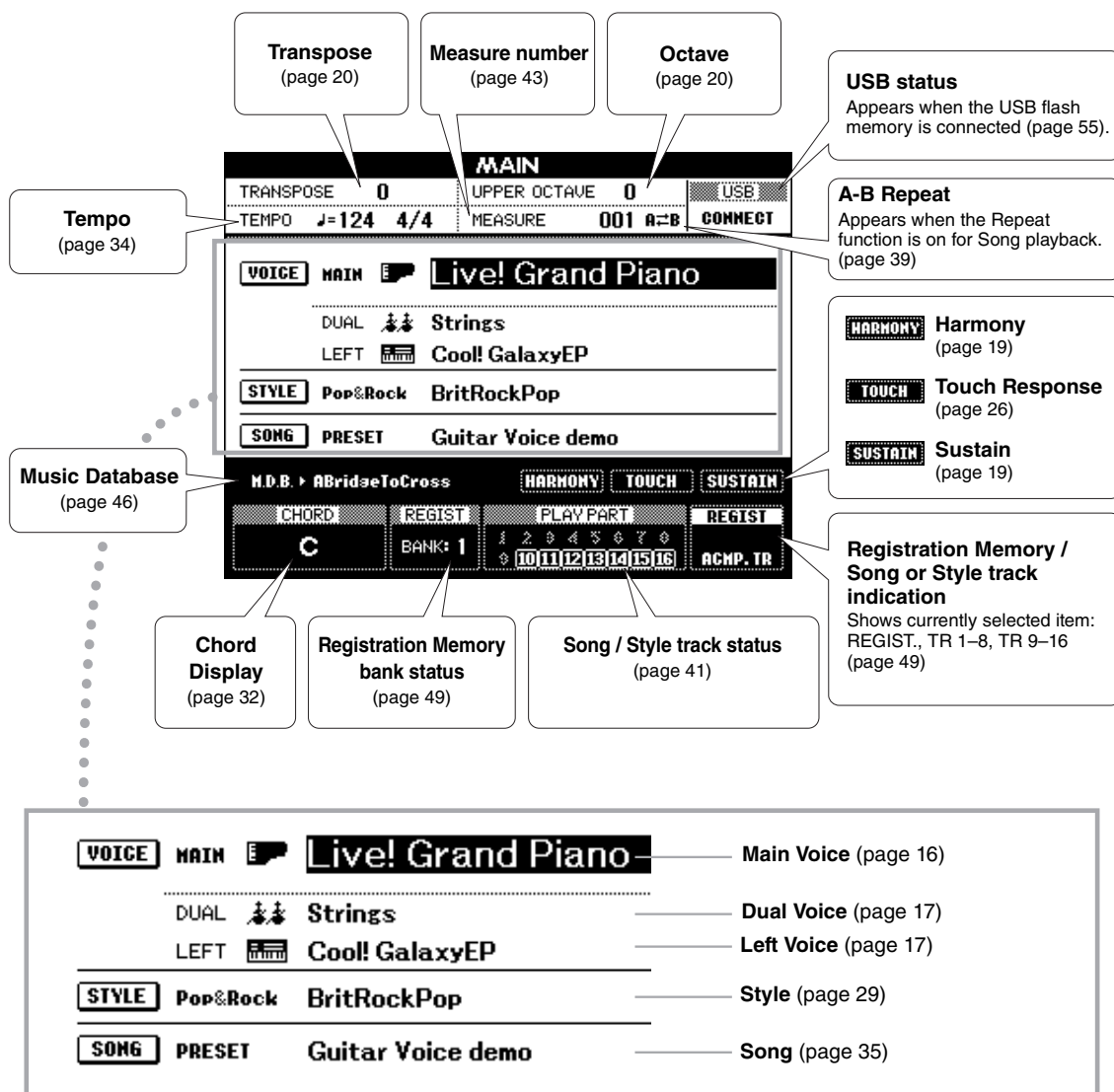

■ To Return to the Main Display

EXIT



Since the instrument has so many different displays, you may occasionally find yourself confused as to which operation's display is currently shown. In such a case, return to the Main display by pressing the [EXIT] button.

VOICE, STYLE, SONG, and MDB Select Displays

Press one of the category selection buttons such as VOICE, STYLE, SONG, or press the [MDB] button to call up selection display for each. In each display, you can select an item as desired using the CATEGORY buttons or the dial.

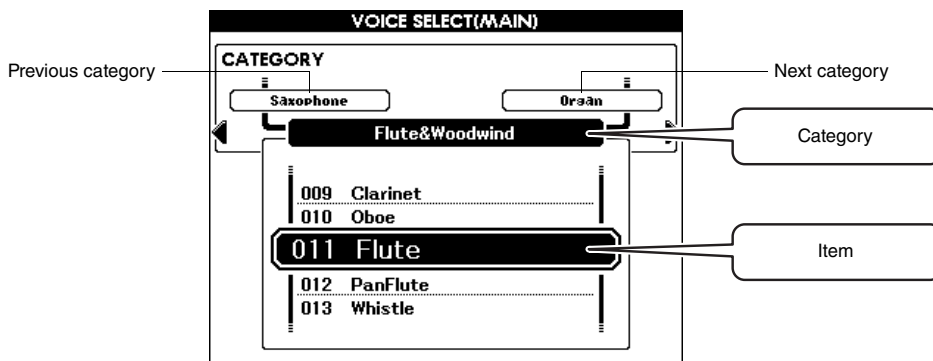

■ Select a Category

Use the CATEGORY [◀] and [▶] buttons to step in sequence through the categories.

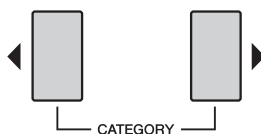

■ Select a Voice, Style, Song or MDB

Use the dial or the [-/NO]/[+/YES] buttons to select an item as desired. Press and hold either button to continuously increment or decrement the value in the corresponding direction.

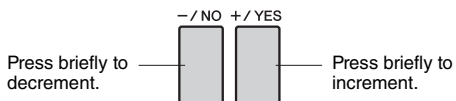
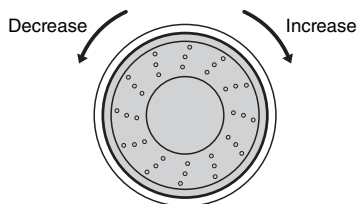

Function Display

In the Function display, you can make detailed settings for this instrument. The Function display appears when the [FUNCTION] button is pressed. In the display you can use the CATEGORY [◀] and [▶] buttons to select 60 different function items. Press the CATEGORY button(s) as many times as necessary until the required function appears, then use the dial or the [-/NO] and [+/YES] buttons to adjust the value of the function as required. To recall the default value, press the [-/NO] and [+/YES] buttons simultaneously.

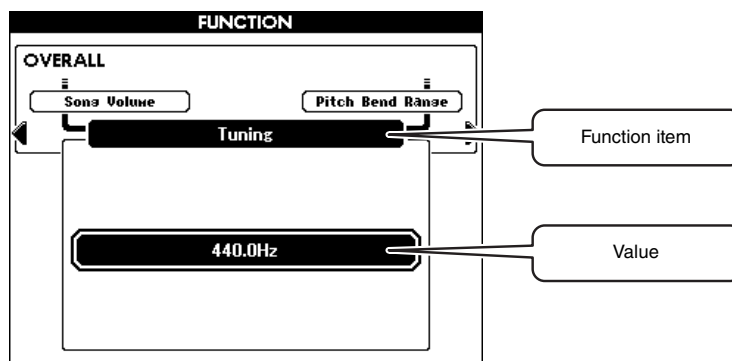

All items which can be selected in the Function display are listed in the Panel Button Chart on page 66.

■ Move the highlighted Position

In some Function displays, pressing the [EXECUTE] button will move the highlighted position from the current one to the other one.



■ Shortcut

You can jump directly to certain Function displays by holding the related button for longer than a second. The buttons are as follows:

- [FUNCTION] buttonScale
- [DEMO] button.....Demo Group
- [ACMP] buttonChord Fingering
- [METRONOME] button..... Time Signature-Numerator
- [FREEZE] button.....Freeze Group Setting
- [HARMONY] button.....Harmony Type
- [TOUCH] button.....Touch Sensitivity
- [DSP] buttonDSP Type

This can be particularly handy since such a large number of Functions are available.

1 Voices – Playing the Keyboard –

In addition to piano, organ, and other standard keyboard instruments, this instrument has a large range of realistic Voices—including guitar, bass, strings, sax, trumpet, drums and percussion, sound effects, and a wide variety of other musical sounds.

Select and Play a Main Voice

In this operation, you'll select a Main Voice and play it on the keyboard.

1 Select and press the desired Voice category button in the Voice section.

The Main Voice selection display will appear. The currently selected category name, Voice number and name will be highlighted.

NOTE 1

- To change the Voice category, press another category button.

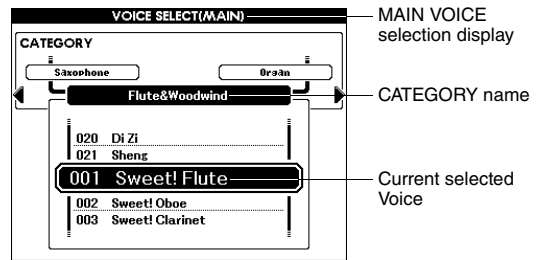
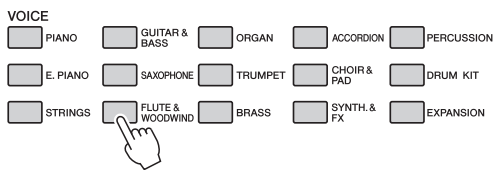

You can select the GM&XG category Voice by pressing the [PIANO] button then CATEGORY [◀] button to call up the GM&XG category.

2 Select the Voice you want to play.

Look at the highlighted Voice name and rotate the dial. The available Voices will be selected and displayed in sequence. The Voice selected here becomes the Main Voice.

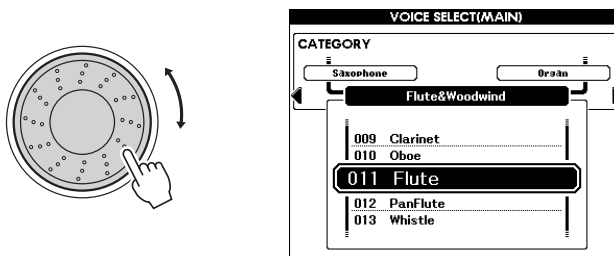

3 Play the keyboard.

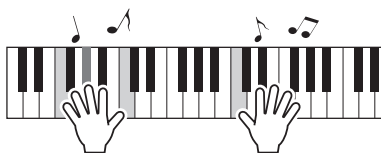

NOTE 1

- The main Voice parameters such as Volume can be set in the Function display. For details, refer to the Reference Manual.

Try selecting and playing a variety of Voices. Press the [EXIT] button to return to the Main display.

Playing Two Voices Simultaneously

Once you press the [DUAL] button to turn the Dual Voice on, a second voice will sound that will play in addition to the Main Voice when you play the keyboard. The second voice is known as the “Dual Voice.”

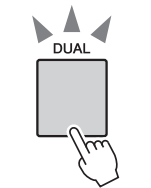

The button lights when Dual is ON.

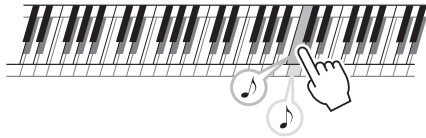

Two Voices will sound at the same time.

NOTE 1

- The Dual Voice parameters such as Voice Volume can be set in the Function display. For details, refer to the Reference Manual.

Press the button again to turn the Dual Voice off.

■ Selecting a Dual Voice

You can select any voice as a Dual Voice. Press and hold the [DUAL] button for longer than a second to call up the Dual Voice selection display, then select a Dual Voice in the same way as selecting a Main Voice. After selecting, press the [EXIT] button to return to the MAIN display.

Splitting the Keyboard and Playing the Left Voice with the Left Hand

Once you press the [LEFT] button to turn the Left Voice on, you can play different Voices to the left and right of the keyboard “split point.” The Main and Dual voices can be played to the right of the split point, while the Voice played to the left of the split point is known as the “Left Voice.”

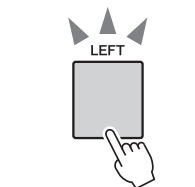

The button lights when Left Voice is ON.

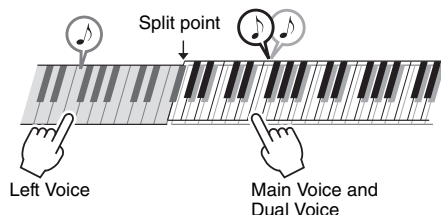

NOTE 1

- The Left Voice parameters such as Volume can be set in the Function display. For details, refer to the Reference Manual.

Press the button again to turn the Left Voice off.

■ Selecting a Left Voice

You can select any voice as a Left Voice. Press and hold the [LEFT] button for longer than a second to call up the Left Voice selection display, then select a Left Voice in the same way as selecting a Main Voice. After selecting, press the [EXIT] button to return to the MAIN display.

Playing Drum Kits

Drum Kits are collections of drum and percussion instruments. When you select a violin or other normal instrument—as a Main Voice, for example—all keys produce the sound of the same violin, only at different pitches. If you select a Drum Kit as the Main Voice, however, each key produces the sound of a different drum or percussion instrument.

1 Press the [DRUM KIT] button.

The “Drum Kit” category appears.

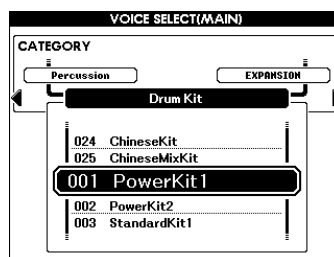
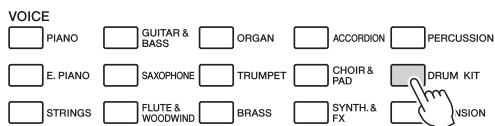

2 Rotate the dial and select the Drum Kit you want to play (001–025).

A good Drum Kit to start out with is 003, Standard Kit 1.

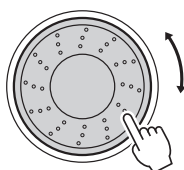

Drum Kit List

Voice No.	Drum Kit name	Voice No.	Drum Kit name	Voice No.	Drum Kit name	Voice No.	Drum Kit name
001	Power Kit 1	008	Room Kit	015	Analog Kit	022	Arabic Mixture Kit
002	Power Kit 2	009	Rock Kit	016	Dance Kit	023	Indian Kit
003	Standard Kit 1	010	Electro Kit	017	Symphony Kit	024	Chinese Kit
004	Standard Kit 2	011	AnalogT8 Kit	018	Cuban Kit	025	Chinese Mixture Kit
005	Hit Kit	012	AnalogT9 Kit	019	PopLatin Kit		
006	Jazz Kit	013	Break Kit	020	Arabic Kit		
007	Brush Kit	014	HipHop Kit	021	Arabic Kit 2		

3 Play each key and enjoy the Drum Kit.

Example: 003 Standard Kit 1

NOTE

- See the Drum Kit List in the separate Data List.

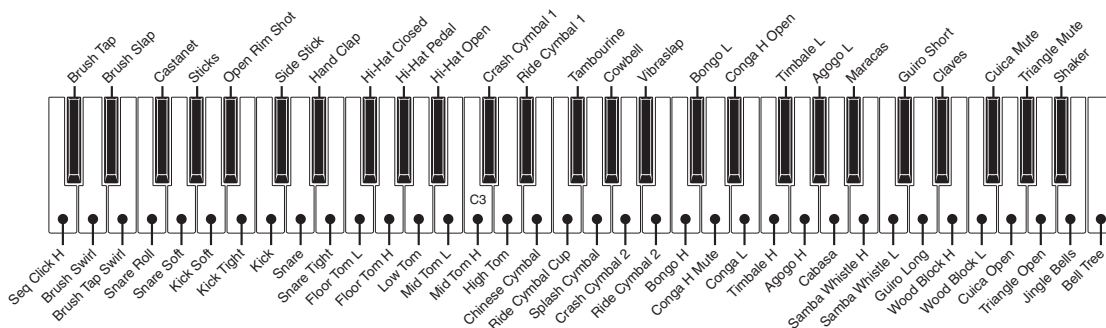

Applying Effects to a Voice

You can apply effects to a Voice played on the keyboard by pressing the Voice Control buttons. To turn the effect off, press the button again.

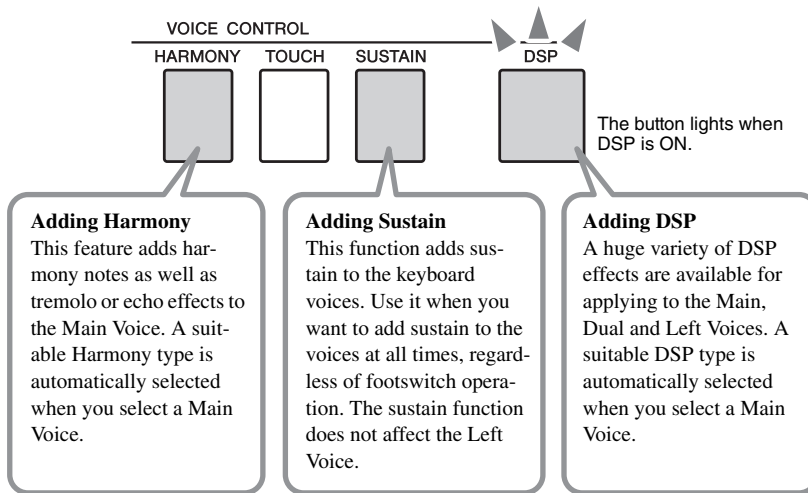

NOTE 1

- You can specify the Harmony type. For details, refer to the Reference Manual.

NOTE 2

- For some Voices, sustain may not be audibly affected when the Sustain is turned on.

NOTE 3

- You can specify the DSP type. For details, refer to the Reference Manual.

You can see the on/off status for the Harmony and Sustain in the Main display.



SUSTAIN Appears when Sustain is on

HARMONY Appears when Harmony is on

How to Play Each Harmony Type

The Harmony behaves differently depending on the type. Check the current Harmony Type on the display by holding the [HARMONY] button for longer than a second.

Harmony types 01 to 10, 13



Press the right-hand keys while playing chords in the Auto Accompaniment range of the keyboard when the Auto Accompaniment is on (page 29).

Harmony types 19 to 22 (Tremolo)



Play the keys.

Harmony types 15 to 18 (Echo)

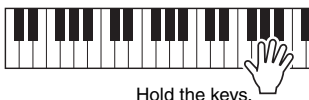

Hold the keys.

Harmony types 23 to 26 (Trill)



Hold down two keys.

Reverb and Chorus

The other effects provided are Reverb and Chorus. Reverb lets you play with a rich concert hall type ambience, and Chorus effect creates a thick sound that is similar to many of the same voices being played in unison. A suitable Reverb type and Chorus type are automatically selected when you select a Style or Song.

NOTE 4

- You can specify the Reverb type and Chorus type. For details, refer to the Reference Manual.

Changing the Pitch of the Instrument

Using the Pitch Bend Wheel

The Pitch Bend wheel can be used to add smooth pitch variations to notes you play on the keyboard.

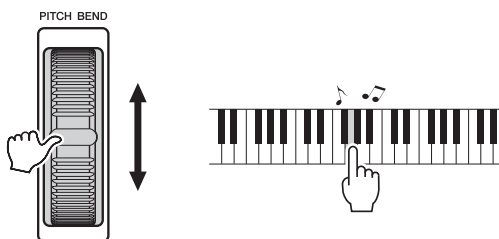

NOTE 1

- The pitch bend range can be changed by setting the "PB Range" parameter on the Function display. For details, refer to the Reference Manual.

Adjusting the pitch in semitones (Transpose)

The overall pitch of the instrument can be shifted up or down in semitones by pressing the TRANSPOSE [+]/[-] buttons. The value is shown in the display, indicating the amount of transposition over or below the normal value between -12 and +12 (a maximum of one octave.) The setting can be reset to the initial default value "00" by pressing the [+] and [-] buttons simultaneously.

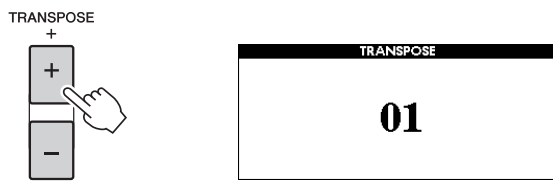

NOTE 1

- This setting does not affect the Drum Kit Voices.

Changing the Pitch in Octaves

You can change the playing pitch of the Main and Dual Voices in octave intervals by pressing the UPPER OCTAVE [-]/[+] buttons. The newly changed value is shown in the display between -1 and +1. The setting can be reset to the initial default value "0" by pressing the [-] and [+] buttons simultaneously.

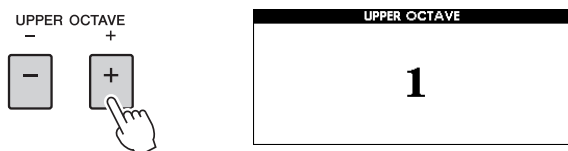

NOTE 1

- When a Drum Kit is selected, each percussion Voice assigned to the keyboard is shifted in location but not pitch.

Fine-tuning the Pitch of the Entire Instrument

You can fine-tune the pitch of the entire instrument by a maximum of 1 semi-tone—useful when you play this instrument along with other instruments or CD music.

NOTE 1

- This setting does not affect the Drum Kit Voices.

1 Press the [FUNCTION] button to call up the Function display.

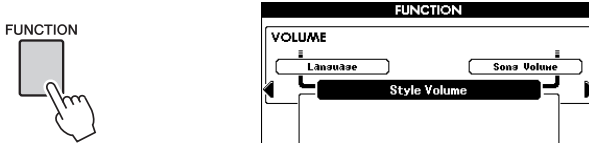

2 Press the CATEGORY [◀] and [▶] buttons as many times as necessary to call up “Tuning.”

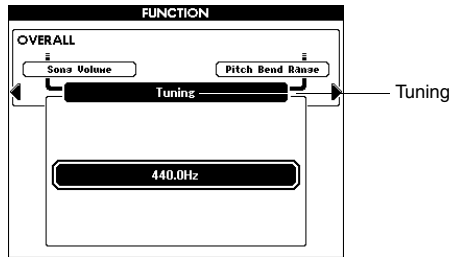

3 Use the dial to set the tuning value between 415.3–466.2Hz as desired.

The range is 415.3–466.2, equivalent to -1semitone – +1semitone.

NOTE 1

- Press the [EXIT] button to return to the Main display.

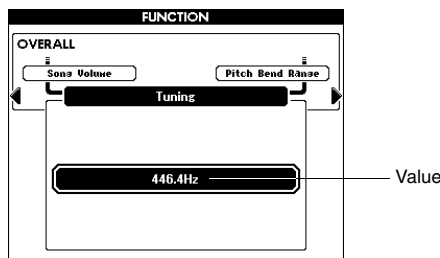

Scale Tuning

By default, this keyboard scale is set to Equal Temperament—the same tuning as with any acoustic piano. However, the setting can be changed to any other scale according to the music genre or music style you want to play.

Selecting a Scale

You can select various scales for playing in custom tunings for specific historical periods or music genres.

Press and hold the [FUNCTION] button for longer than a second to call up the Scale select display, then rotate the dial to select the desired Scale. The setting can be reset to the initial default value by pressing the [-/NO] and [+ /YES] buttons simultaneously.

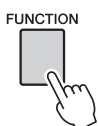

Hold for longer than a second

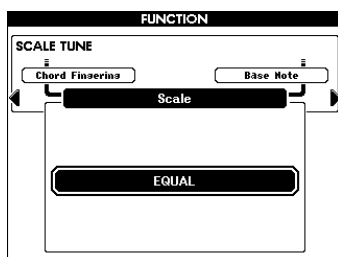

NOTE 1

- This setting does not affect the Drum Kit Voices.

NOTE 2

- Press the [EXIT] button to return to the Main display.

Preset Scale types

EQUAL	The pitch range of each octave is divided equally into twelve parts, with each half-step evenly spaced in pitch. This is the most commonly used tuning in music today.
PURE MAJOR, PURE MINOR	These tunings preserve the pure mathematical intervals of each scale, especially for triad chords (root, third, fifth). You can hear this best in actual vocal harmonies—such as choirs and a cappella singing.
PYTHAGOREAN	This scale was devised by the famous Greek philosopher and is created from a series of perfect fifths, which are collapsed into a single octave. The 3rd in this tuning are slightly unstable, but the 4th and 5th are beautiful and suitable for some leads.
MEAN-TONE	This scale was created as an improvement on the Pythagorean scale, by making the major third interval more “in tune.” It was especially popular from the 16th century to the 18th century. Handel, among others, used this scale.
WERCKMEISTER, KIRNBERGER	This composite scale combines the Werckmeister and Kirnberger systems, which were themselves improvements on the mean-tone and Pythagorean scales. The main feature of this scale is that each key has its own unique character. The scale was used extensively during the time of Bach and Beethoven, and even now it is often used when performing period music on the harpsichord.
ARABIC1, ARABIC2	Use these tunings when playing Arabic music.

NOTE 3

- “(Edited)” will appear in the display if you have created your original scale using the “Scale Tune” function (page 23).

Setting the Base Note for Each Scale

When the base note is changed, the pitch of the keyboard is transposed, yet the original pitch relationship between the notes is maintained. Please make sure to specify the appropriate Base Note, if you select a scale other than Equal Temperament, or create an original scale via Scale Tune function.

Press the [FUNCTION] button then use the CATEGORY [◀] and [▶] buttons as many times as necessary to select the “Base Note.” Use the dial to select the Base Note from C, C#, D, E_b, E, F, F#, G, A_b, A, B_b, B.

The setting can be reset to the initial default value by pressing the [-/NO] and [+ /YES] buttons simultaneously.

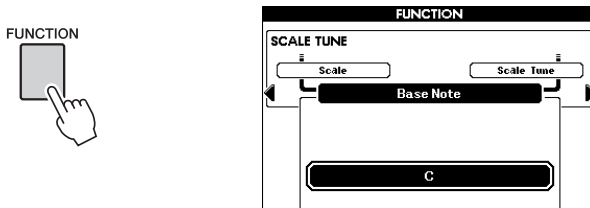

Tuning Each Note to Create an Original Scale

You can tune the individual notes in cents to create your original scale. The term “cent” refers to one hundredth of a semitone (i.e., 100 cents = 1 semitone). After selecting the appropriate Base Note, follow the instructions below.

1 Press the [FUNCTION] button then use the CATEGORY [◀] and [▶] buttons as many times as necessary to select “Scale Tune.”

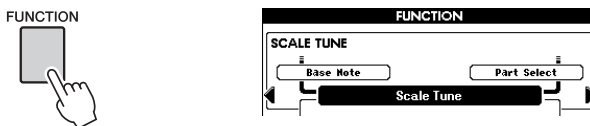

2 Use the dial to select the note to be tuned, then press the [EXECUTE] button.

The tuning value is highlighted, allowing you to tune the note.

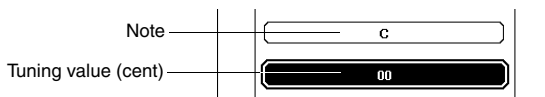

3 Use the dial to tune the note, then press the [EXECUTE] button.

The tuning range is between -64 – +63. The setting can be reset to the initial default value by pressing the [-/NO] and [+ /YES] buttons simultaneously.

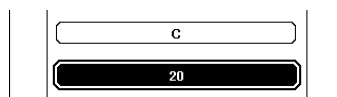

NOTE 1

The settings here are linked with the Base Note. For example, if the Base Note for the original scale is changed from C to F, the tuning values for keys C–B are shifted to F–E.

4 Repeat steps 2–3 to tune any of the remaining notes.

5 Memorize the settings here to the Registration Memory as desired (page 50).

NOTE 1

- Press the [EXIT] button to return to the Main display.

Selecting a Part for Scale Tune

With the initial settings, Scale Tune is applied only to the Main/Dual Voices, not to the Left Voice and Style playback. If you want to apply this setting to the Left Voice or Style playback as well as the Main/Dual Voices, follow the instructions below.

1 Press and hold the [FUNCTION] button for longer than a second to call up the Scale select display.

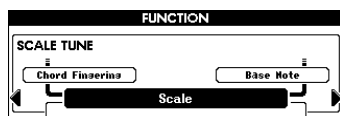
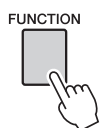

2 Use the CATEGORY [▶] button as many times as necessary to select “Part Select.”

The Part and ON/OFF status are shown.

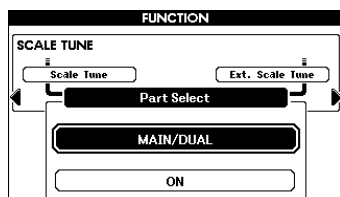
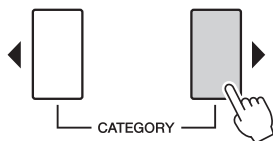

3 Use the dial to select the part, then press the [EXECUTE] button.

Select the desired part from Main/Dual Voices, Left Voice, and Style. After that, press the [EXECUTE] button so that the highlighted area will move to the ON/OFF status.

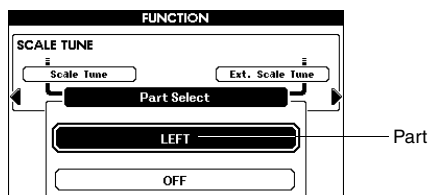
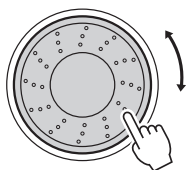

4 Rotate the dial to select ON (apply) or OFF (not apply), then press the [EXECUTE] button.

The highlighted area will return to Part Select again. Repeat steps 3–4 as desired.

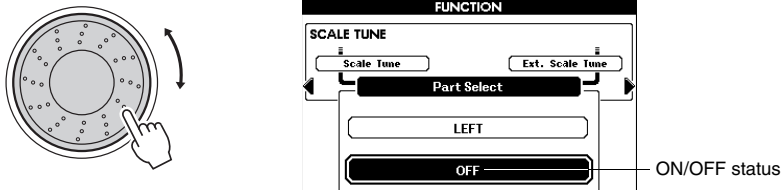

5 Memorize the settings here to the Registration Memory as desired (page 50).

Applying Scale Tune MIDI Messages to the Keyboard Performance

You can apply Scale Tune MIDI messages received from an external MIDI device to the keyboard performance. The default setting applies MIDI messages to Song playback; however, you can change it to the keyboard performance by following the instructions below.

1 Press and hold the [FUNCTION] button for longer than a second to call up the Scale select display.

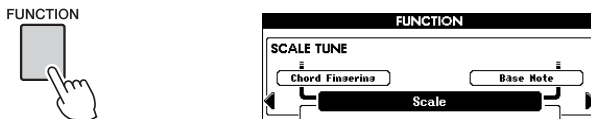

2 Use the CATEGORY [▶] button as many times as necessary to select “External Scale Tune.”

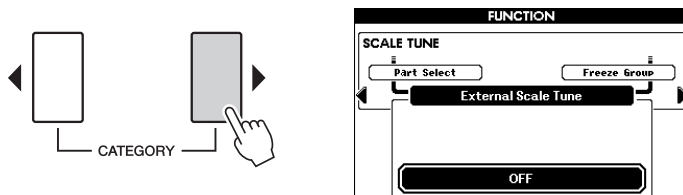

3 Rotate the dial to select ON (KEYBOARD).

With the default setting of “OFF,” MIDI messages are applied to Song channels 1–16, not to the keyboard performance.

If you set this to “ON (KEYBOARD),” the MIDI messages are applied to the keyboard performance as follows: Channel 1 = Main Voice, Channel 2 = Dual Voice, and Channel 3 = Left Voice; the other channels are not affected.

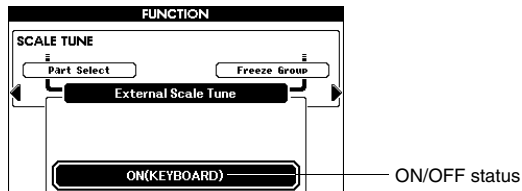
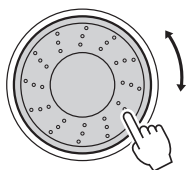

Touch Response ON/OFF

The keyboard of this instrument is equipped with a Touch Response feature that lets you dynamically and expressively control the level of the voices with your playing strength. However, you may want to produce the same volume no matter how strongly or softly you play the keyboard, depending on the Voice. In this case, press the [TOUCH] button to turn this function off. You can see the on/off status for Touch Response in the Main display.

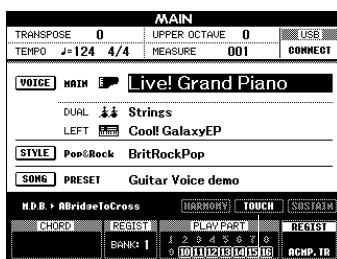
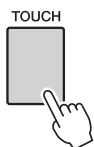

TOUCH Appears when Touch Response is on

NOTE 1

- *Touch Sensitivity, or how the sound volume responds to the playing strength, can be set in the Function display. For details, refer to the Reference Manual.*

Using the Metronome

Playing the Metronome

The metronome provides a click sound, giving you an accurate tempo guide when you practice, or letting you hear and check how a specific tempo sounds. Press the [METRONOME] button to start the metronome. To stop the metronome, press the [METRONOME] button again.

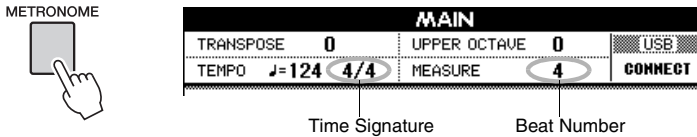

Setting the Time Signature and Tempo

Normally, the metronome time signature and tempo will be determined by the current Style or Song. The current value is shown in the upper left corner of the Main display. If you want to change the time signature or tempo, follow the instructions below.

1 Press and hold the [METRONOME] button for longer than a second.

The currently selected time signature is shown. In this example we'll set up a 3/4 time signature.

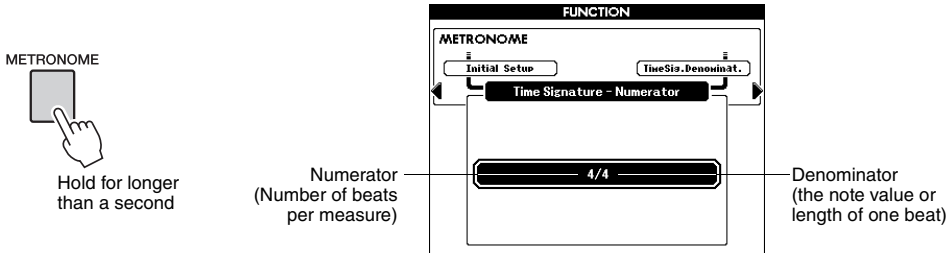

You can set the Numerator in this display.

2 Use the dial to select the number of beats per measure.

The Bell will sound on the first beat of each measure while a metronome “click” will sound on all others. You can set the time signature from 01 to 60. Select “3” for this example.

NOTE

- If you start playback of the Style or Song, the metronome time signature is changed to that of the Style or Song that is playing.

3 Press the **CATEGORY** [▶] button once to call up the **Time Signature Denominator** display.

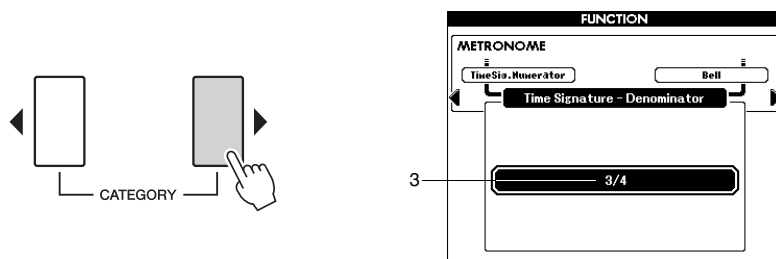

4 Use the dial to select a beat length.

Select the required length for each beat: 2, 4, 8, or 16 (half note, quarter note, eighth note, or 16th note). For this example, select 4. The time signature should now be set to 3/4.

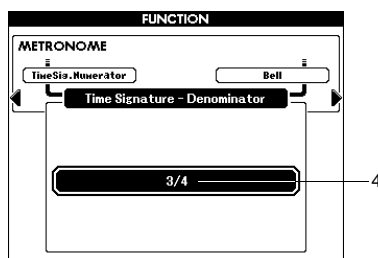

Press the [METRONOME] button to confirm the settings.

5 Use the **TEMPO** [+] and [-] buttons to set the tempo.

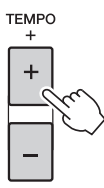

Or press any of the TEMPO buttons once to call up the Tempo setting in the display, then use the dial to set the value.

NOTE 1

- Other metronome settings such as Volume or Bell sound can be set in the Function display.

This instrument includes the Auto Accompaniment feature that plays appropriate “Styles” (rhythm + bass + chord accompaniment) when you play left-hand chords. You can select from a huge variety of Styles covering a wide range of musical genres.

Select and Play a Style

1 Select and press the desired Style category button.

The Style selection display appears.

The current category name, Style number and name will be highlighted.

NOTE 1

- In addition to the Preset Styles, you can create your own Style. For details, refer to the “Style Creator” chapter of the Reference Manual.

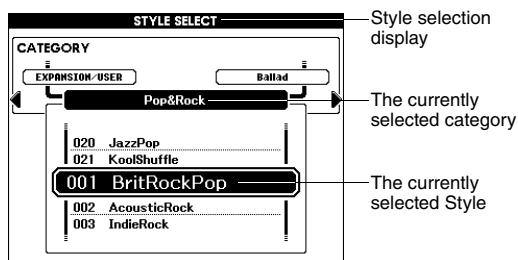
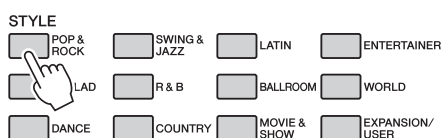

2 Select the Style you want to play.

Look at the highlighted Style name and rotate the dial. The available Styles will be selected and displayed in sequence. See the Style list in the separate Data List.

NOTE 1

- The [EXPANSION/USER] button is used for calling up your original Styles created with the Style Creator, or Styles loaded/installed from a USB flash memory (pages 59 and 61.) For details about the Style Creator, refer to the Reference Manual.

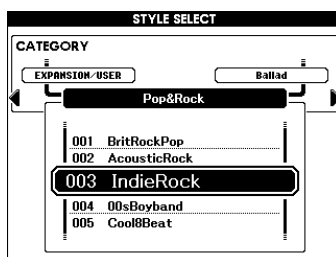
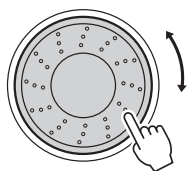

3 Turn the Auto Accompaniment on.

Press the [ACMP] button. Pressing this button again will turn the Auto Accompaniment off.

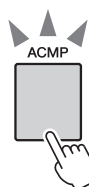

The [ACMP] button lights when the Auto Accompaniment is turned on.

2. Styles – Playing Rhythm and Accompaniment –

When the Auto Accompaniment is on...

The area of the keyboard to the left of the split point (F#2) becomes the Auto Accompaniment range and is used only for specifying the Accompaniment chords.

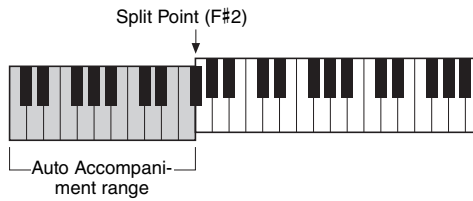

NOTE 1

- The Split Point can be changed in the Function display. For details, refer to the Reference Manual.

- 4 Press the [AUTO FILL IN] button to turn Auto Fill In on. The initial setting is “on.”

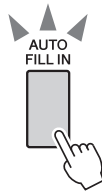

The button lights when Auto Fill In is ON.

- 5 Press the [SYNC START] button to turn Synchro Start on.

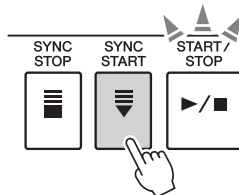

The [SYNC START] button lights indicating Synchro Start is engaged.

NOTE 1

- You can start the Style by simply tapping the [TEMPO/TAP] button at the required tempo—four times for time signatures in 4, and three times for time signatures in 3. You can change the tempo during style playback by pressing the button just twice.
- You can also press the [START/STOP] button to begin the rhythm of the selected Style. The bass and chords will begin playing as soon as you play a key in the Auto Accompaniment range of the keyboard.

Synchro Start

When Synchro Start is on, you can start the Style by playing any key in the accompaniment range of the keyboard. To cancel or disable Synchro Start, press the button again.

- 6 Press one of the MAIN VARIATION [A]–[D] buttons as desired. The selected Main Variation button flashes.

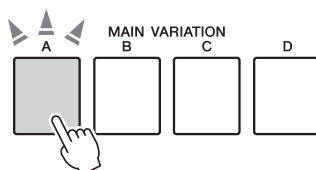

7 Press one of the INTRO [I]–[III] buttons.

The selected Intro button lights.

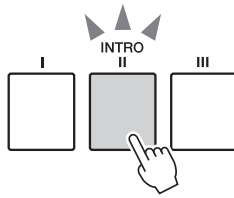

8 Play a chord in the Auto Accompaniment range to start the Intro section.

Try playing a C major chord. (See “Playing Auto Accompaniment Chords” on page 32.)

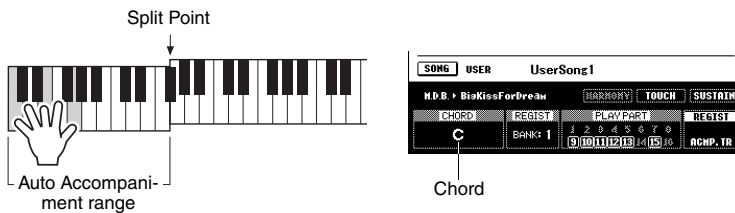

NOTE 1

- The Baroque Air Style in the MOVIE & SHOW category does not have a Rhythm part, and so does not produce any rhythm sound.

When the playback of the intro is finished, it automatically leads into the Main Variations.

9 Press one of the MAIN VARIATION [A]–[D] buttons.

The Main Variation corresponding to the pressed button plays following an automatic fill-in.

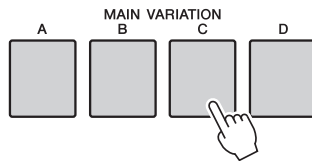

10 Press one of the ENDING/rit. [I]–[III] buttons.

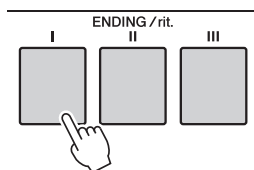

NOTE 1

- The Style Volume can be adjusted in the Function display. For details, refer to the Reference Manual.

This switches to the Ending section. When the Ending is finished, the Style playback stops automatically. You can have the Ending gradually slow down (ritardando) by pressing the same ENDING/rit. button again while the Ending is playing back.

Playing Auto Accompaniment Chords

For users who are unfamiliar with chords, this handy chart features common chords for your quick reference. Chords recognized by this instrument are described in the Reference Manual on the website.

★ Indicates the root note.

Major	Minor	Seventh	Minor Seventh	Major Seventh
C 	Cm 	C7 	Cm7 	CM7
D 	Dm 	D7 	Dm7 	DM7
E 	Em 	E7 	Em7 	EM7
F 	Fm 	F7 	Fm7 	FM7
G 	Gm 	G7 	Gm7 	GM7
A 	Am 	A7 	Am7 	AM7
B 	Bm 	B7 	Bm7 	BM7

Easy Chords

This method lets you easily play chords in the accompaniment range of the keyboard using only one, two, or three fingers.

For root "C"



To play a major chord
Press the root note (★) of the chord.

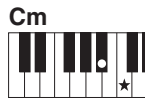

To play a minor chord
Press the root note together with the nearest black key to the left of it.



To play a seventh chord
Press the root note together with the nearest white key to the left of it.

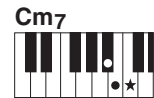

To play a minor seventh chord
Press the root note together with the nearest white and black keys to the left of it (three keys altogether).

Changing the Chord Fingering Type

You can select the different chord fingering type such as normal chords played anywhere on the keyboard will be detected in it. Chord fingering type can be changed in the Function display. For details, refer to the Reference Manual.

Synchro Stop

When this function is selected, the accompaniment Style will only play while you are holding down chords in the Accompaniment range of the keyboard. Style playback will stop when you release the keys. To turn the function on, press the [SYNC STOP] button. To turn the function off, press the button again.

NOTE 1

- This function cannot be used if the "FullKeyboard" is selected from the "Chord Fingering" parameter on the Function display.

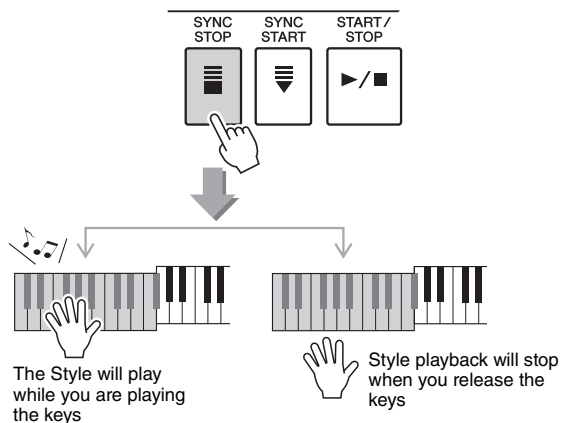

Select and Play a Style from USB Flash Memory

Styles on a USB flash memory connected to the USB TO DEVICE terminal can be directly selected and played. Press the [USB] button in the Style mode (page 35) and the name of the currently selected Style on the USB flash memory will appear in the display. Rotate the dial to select the desired Style, then play the Style by following the instructions on pages 29–31

NOTE 1

- Before using a USB flash memory, be sure to read "Precautions when using the [USB TO DEVICE] terminal" on page 54.

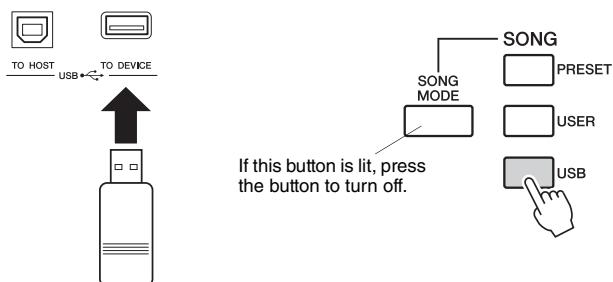

The Style files must be saved either in the USB flash memory's root directory or a first-level/second-level/third-level folder in the root directory. The directory can be moved using the CATEGORY [◀]/[▶] buttons.

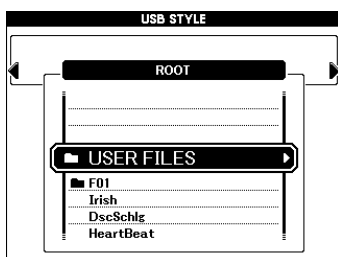

Changing the Tempo

You can use the TEMPO [+] and [-] buttons to adjust the playback tempo as required before or during playback. While the TEMPO pop-up is shown on the display, you can also use the dial to adjust the value. Pressing the TEMPO [+] / [-] buttons simultaneously resets the tempo to the default value.

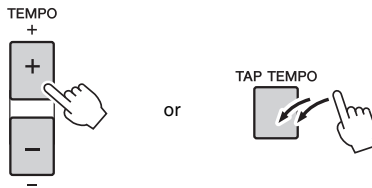

The Tempo can also be changed during playback by tapping the [TAP TEMPO] button twice at the desired tempo.

One Touch Setting

With all the choices available on the instrument, sometimes selecting the ideal Voice to play with a Song or Style can be confusing. The One Touch Setting feature automatically selects four ideally matched Voices for the Style you've selected.

Select the desired Style (See page 29), then press one of the ONE TOUCH SETTING [1]–[4] buttons to call up the appropriate panel settings. As soon as you play a chord with your left hand, the selected Style starts. Try selecting other ONE TOUCH SETTING [1]–[4] buttons and listen to the results.

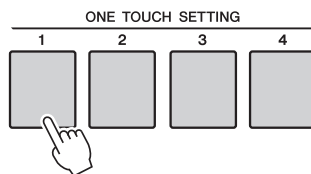

Variation Change and OTS (OTS LINK)

When one of the Main Variations [A]–[D] changes to another Main Variation while OTS LINK is on, the OTS number (1–4) automatically changes according to the selected variation number.

Press the [OTS LINK] button to turn on the OTS link.

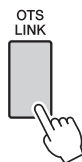

3

Using Songs

With this instrument, the term “Song” refers to the data that makes up a piece of music.

In this section we’ll learn how to select and play a Song.

Selecting and Listening to a Song

1 Press the desired Song category button.

The Song selection display will appear. The currently selected Song number and name will be highlighted.

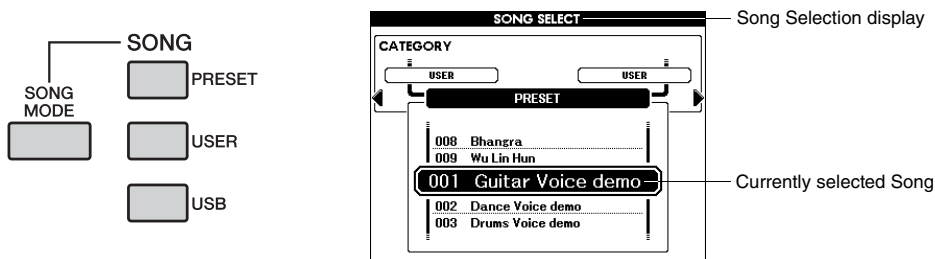

[PRESET] : Nine preset Songs are available here.

[USER] : This contains your recorded Songs and Songs loaded from a USB flash memory or transferred from a computer. For details about how to load Songs, refer to page 59.

[USB] : This contains Songs on a USB flash memory connected to the USB TO DEVICE terminal. For details, refer to page 37.

Song mode and Style mode



The instrument has two modes: Song and Style. In the Song mode, you can play, record and edit Songs, while the Style mode lets you play and create Styles. To alternate between the two modes, press the [SONG MODE] button.

The Song mode has the following limitations:

- Some buttons in the Style Control section become Song related buttons, and other buttons are disabled.
- The [ACMP] button cannot be turned on.
- Styles cannot be played.

2 Select the desired Song.

Use the dial to call up the Songs in order within the category selected in step 1.

3. Using Songs

PRESET	Built-in Songs
	001 Guitar Voice demo (Original)
	002 Dance Voice demo (Original)
	003 Drums Voice demo (Original)
	004 Amazing Grace (Traditional)
	005 Annie Laurie (Traditional)
	006 Latin (Original)
	007 Arabic (Original)
	008 Bhangra (Original)
	009 Wu Lin Hun (Original)
USER	001–005 User Songs (Songs you record yourself)
	006– Songs loaded from a USB flash memory/transferred from a computer
USB	Songs in a USB flash memory connected to the instrument

* Some of the preset songs have been edited for length or arrangement, and may not be exactly the same as the original.

* Preset Song 004 is displayed as “Score demo”, and preset Song 005 as “Lyric demo” in the display.

3 Listen to the Song.

Press the [▶/■] button to begin playback of the selected Song.

You can stop playback at any time by pressing the [▶/■] button again.

NOTE

- Press the [EXIT] button to return to the Main display.

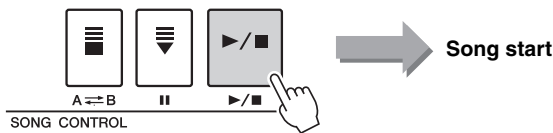

You can turn individual tracks of the Song on and off. For details, refer to the Reference Manual.

Changing the Tempo

This is the same as changing the Style tempo. For details, refer to page 34.

Fast Forward, Fast Reverse, and Pause

These are similar to the transport controls on a CD player, letting you fast forward [▶▶], rewind [◀◀], and pause [II] playback of the Song.

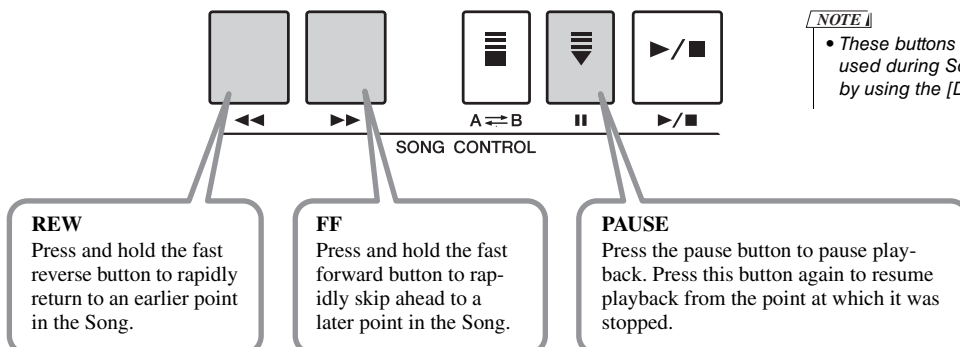

NOTE

- These buttons cannot be used during Song playback by using the [DEMO] button.

Listening to the Demo Song

This instrument includes a Demonstration Song, showcasing the wide variety of the Preset Voices.

Press the [DEMO] button to start the Demo.

The Demo displays appear in the display.

The Demo Song will restart when playback reaches the end.

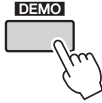

You can stop playback at any time by pressing the [DEMO] or [▶/■] button.

You can change the repeat playback target from Demo Song to other Songs such as Preset Songs. Press and hold the [DEMO] button for longer than a second to call up the “Demo Group” selection display, and use the dial to select a repeat playback group from the table below. Press the [DEMO] button to start sequential playback of the Songs in the selected group.

Demo	Demo Song
Preset	All Preset songs
User	All User songs
Download	All Songs transferred from a computer
USB	All Songs on a USB flash memory connected to the instrument.

Select and Play a Song from USB Flash Memory

Songs on a USB flash memory connected to the USB TO DEVICE terminal can be directly selected and played. Press the [USB] button in the Song mode (page 35) and the name of the currently selected Song on the USB flash memory will appear in the display. Rotate the dial to select the desired Song, then press the [▶/■] button to start playback.

NOTE 1

- Before using a USB flash memory, be sure to read “Precautions when using the [USB TO DEVICE] terminal” on page 54.

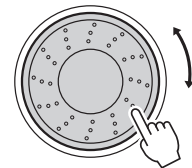
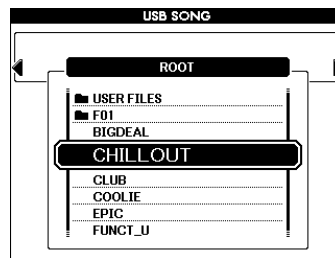
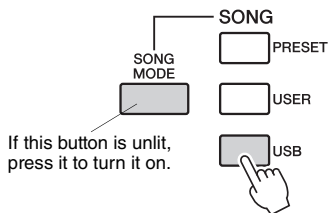

The Song files must be saved either in the USB flash memory’s root directory or a first-level/second-level/third-level folder in the root directory. The directory can be moved using the CATEGORY [◀]/[▶] buttons.

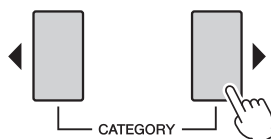

Displaying the Song Score

This instrument is capable of displaying the scores (notation) of Songs, including the preset Songs as well as Songs loaded from a USB flash memory or computer.

1 Select a Song.

Follow steps 1 and 2 on page 35.

2 Press the [SCORE] button and a single-staff score will appear.

There are two types of score display: single-staff and double-staff. These are alternately selected each time the [SCORE] button is pressed.

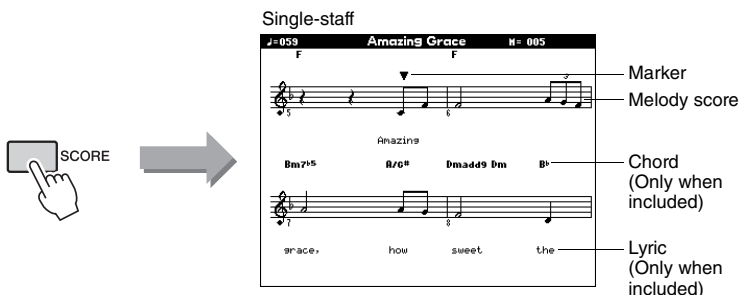

NOTE 1

- When there are many lyrics in a Song, they may be displayed in two rows a measure.
- Some lyrics or chords may be abbreviated if the selected Song has a lot of lyrics.
- Small notes that are hard to read may be easier to read after you change the quantize setting in the Function display. For details, refer to the Reference Manual.

NOTE 2

- No lyrics and chords are shown in the double staff display.

During playback, the marker will indicate the current position in the score.

Displaying the Lyrics

If a Song contains lyric data, the lyrics can be shown on the display.

1 Select a Song.

Follow steps 1 and 2 of the procedure described on page 35. Here, select Preset Song 004 or 005.

2 Press the [LYRICS] button.

The title, lyricist, and composer of the Song will appear on the display.

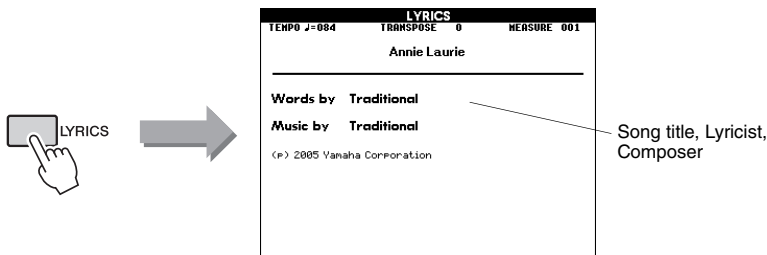

NOTE 1

- Songs downloaded from the Internet or commercially available Song files, including XF format files (page 6), are compatible with the lyrics display features as long as they are standard MIDI file format files containing lyric data. Lyrics display may not be possible with some files.

NOTE 2

- If the lyrics display shows garbled characters, try changing the display language (page 12).

During playback, the lyrics and chords are shown in succession on the display.

A-B Repeat

You can specify a section of a Song—“A” is the start point and “B” is the end point—for repeat playback. The A-B Repeat function is also very convenient for practicing when used along with the score display features of the instrument.



- 1 Play the Song (page 35) and press the [A ⇌ B] button at the beginning of the section you want to repeat (the “A” point).

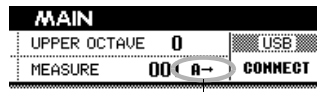
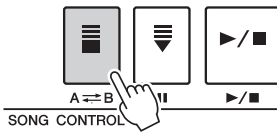

Point A

- 2 Press the [A ⇌ B] button again at the end of the section you want to repeat (the “B” point).

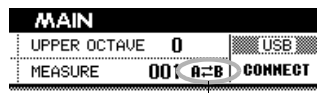
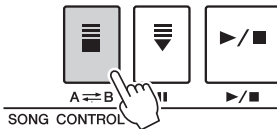

Point B

- 3 After a lead-in count, the specified A-B section of the Song will now play repeatedly.

You can cancel A-B repeat playback at any time by pressing the [A ⇌ B] button.

NOTE

- The current measure number is shown in the display during playback.
- If you want to set the start point “A” at the very beginning of the Song press the [A ⇌ B] button before starting playback of the Song.

4 Recording Your Own Performance

You can record up to five of your own performances and save them as User Songs 001 through 005. These Songs can be played in the same manner as the Preset Songs. Once your performances have been saved as User Songs, they can be saved to a USB storage device (page 58).

■ Recordable data

Melody performance and Style playback with chord or section changes can be recorded to any 16 tracks of the Song.

■ Recording methods

- Quick Recording Immediately start recording with Style playback by pressing the [REC] button. This method automatically sets tracks 1–3 as melody parts and tracks 9–16 as Style parts. This is especially convenient and easy when recording a new Song.
- Multi Recording Specify the Song number and the parts for the tracks and then start recording (page 41). This is useful when you want to record data to each track independently, one by one.

NOTE

- Up to approximately 30,000 notes can be recorded, if you record only to the melody tracks.

Quick Recording Procedure

1 Enter the Song mode (page 35), then press the [REC] button.

The [REC] button lamp lights, and the User Song number for recording will be selected automatically.

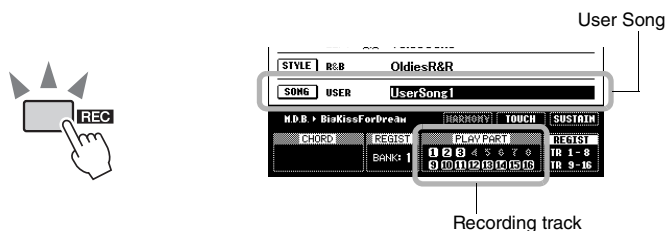

NOTICE

- If all User Songs contain recorded data, User Song 001 will automatically be selected. If you record your performance to a Song that contains data, the previous data will be erased by the new data.

NOTE

- You can manually select the recorded user Song number if you select it before pressing the [REC] button.

Performance parts are as follows:

Tracks [9]–[16] will be set for Style playback and the Record Ready mode is enabled automatically.

Recording track	Part recorded to each track
Track 1	Main Voice performance
Track 2	Left Voice performance
Track 3	Dual Voice performance
Tracks 9–16	Style playback with chord/section changes

To cancel recording, press the [REC] button or [EXIT] button. (The [REC] button lamp turns off.)

- 2 Play the keyboard to start recording.
- 3 Stop recording by pressing the [▶/■] or [REC] button.

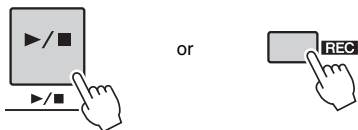

- 4 Press the [+ / YES] button to save the recorded Song.

When recording is stopped, a message asking if you want to save the Song will appear. Press the [+ / YES] button to save the Song, or the [- / NO] button if you don't want to save. If the [+ / YES] button is pressed, the Song will be saved as a MIDI file to the User Song selected in step 1.

Track numbers containing recorded data are indicated with framed rectangles.

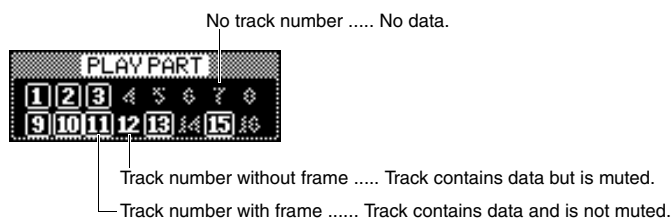

NOTICE

- **Never attempt to turn the power off when a "Writing!" message is shown in the display. Doing so will result in a loss of the recorded data.**

NOTE

- A message asking if you want to save the Song appears again when you select a different Song without saving. To save the Song, press the [+ / YES] button; to cancel, press the [- / NO] button.

- 5 Press the [▶/■] button to play back the recorded Song.

Multi-track Recording Procedure

- 1 Press the [USER] button, then use the dial to select the desired User Song number (001–005) for recording.

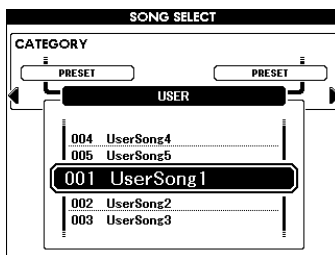
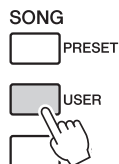

- 2 Press the [EXIT] button to return to the Main display, then assign the Part (Style, Main, Dual and Left) to each recording track.

4. Recording Your Own Performance

■ Assigning the Style Part

If you want to record the Style playback, hold the [REC] button then immediately press the [ACMP] button. On the panel, the [REC] and [ACMP] buttons will light and the [START/STOP] button will flash, indicating that Record Ready mode is enabled with the Auto Accompaniment on. On the display, the REC indication will be highlighted, indicating that the Style Part will be assigned to Tracks 9–16 for recording.

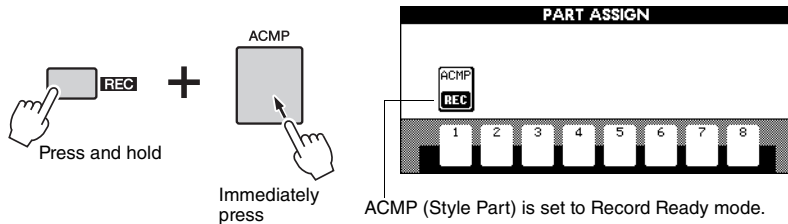

Execute the same operation again to cancel this status.

■ Assigning the Melody Part (MAIN, DUAL and LEFT)

When the [ACMP] button is turned on:

Hold the [REC] button then immediately press one of the SONG Track [1]–[8] buttons to call up the PART ASSIGN display. While continuing to hold the [REC] button, repeatedly press the same Track button. The Track box indication is alternated as follows: MAIN → DUAL → LEFT → (empty) → MAIN → ... Here, assign the MAIN part to the pressed Track.

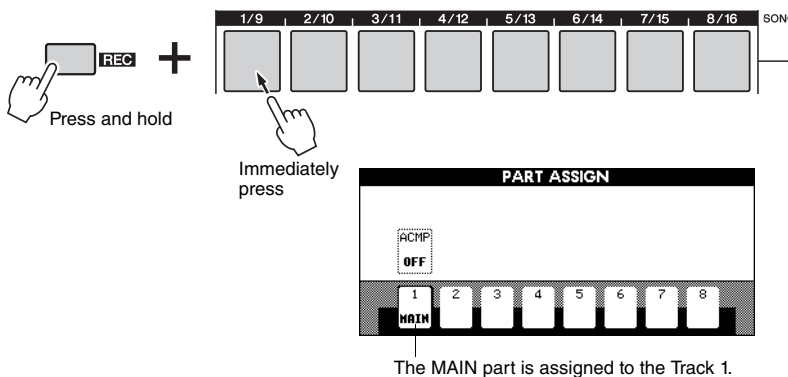

Execute the same operation to assign the MAIN, DUAL, and LEFT parts to the different Tracks respectively.

When the [ACMP] button is turned off:

On the Main display, press the [REGIST/PART [MIXER]] button until your desired Track group (“TR1-8” or “TR9-16”) is highlighted in the bottom right corner of the display.



After that, execute the same operation as that of “When the [ACMP] button is turned on:” described above.

NOTICE

- If you assign the Part to a Track containing data, the Recording operation will erase the previous data.

NOTE 1

- The [ACMP] button on/off cannot be changed after the Recording starts.

NOTE 1

- The Part can be assigned only to a single Track.

3 Play the keyboard to start recording.

You can also start recording by pressing the [▶/■] button to play only the rhythm.

When recording is started, the display automatically returns to the Main display, showing the current measure number.

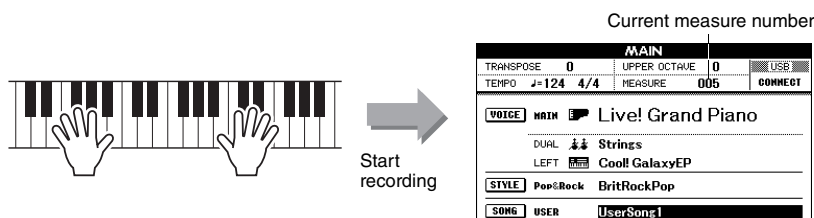

NOTE 1

- When Song memory becomes full, a message appears in the display and recording will be stopped. In this case, delete any unnecessary Song data by using Song clear (page 44) or track clear (page 45) then start recording again.

4 Stop recording by pressing the [▶/■] or [REC] button.

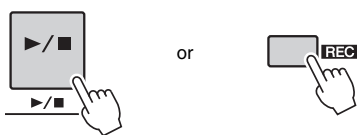

NOTE 1

- If you press one of the END-ING/rit. [I]–[III] buttons while recording the ACMP track, recording will stop as soon as the Ending reaches to the end.

When recording stops, the current measure number will return to 001 and the recorded track numbers in the display will be shown in a box border. The corresponding track button will light up in green. A message prompting you to confirm saving of the data will appear.

5 Press the [+ / YES] button to save the recorded Song.

Press the [+ / YES] button to save the song, or the [- / NO] button if you don't want to save the song. If the [+ / YES] button is pressed, the song will be saved as a MIDI file to the User Song selected in step 1.

To Record Other Tracks.

Repeat steps 2 through 5 to record any of the remaining tracks.

You can listen to the previously recorded tracks while recording. Previously recorded track numbers are shown in a box border. You can also mute previously recorded tracks (the muted tracks will not appear in the display) by pressing the appropriate [1/9]–[8/16] buttons while recording new tracks.

Redo the Recording

Simply select the track you want to re-record for recording in the normal way. The newly recorded material will overwrite the previous data.

NOTICE

- Never attempt to turn the power off when a "Writing!" message is shown in the display. Doing so will result in a loss of the recorded data.

NOTE 1

- A message asking if you want to save the Song appears again if you select a different Song without saving your Song. To save the Song, press the [+ / YES] button; to cancel, press the [- / NO] button.

6 Press the [▶/■] button to play back the recorded Song.

■ If you want to save the Song to a USB flash Memory as backup, refer to page 58.

NOTE 1

- The Style number, Style volume and Time signature are recorded only at the top of the Song. These cannot be recorded at the middle of the Song.

Song Clear—Deleting User Songs

This function clears an entire user Song (all tracks).

NOTE

- If you want to clear a specified track, refer to the Track Clear operation on page 45.

- 1 Press the [USER] button, then rotate the dial to select the user Song (001 to 005) you want to clear.

Press the [EXIT] button to return to the Main display.

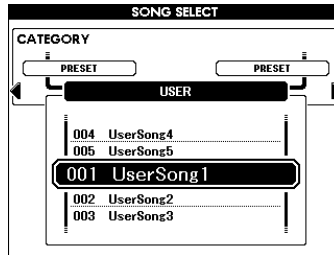
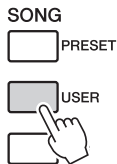

- 2 While holding the TRACK [8/16] button, press and hold the TRACK [1/9] button for longer than a second.

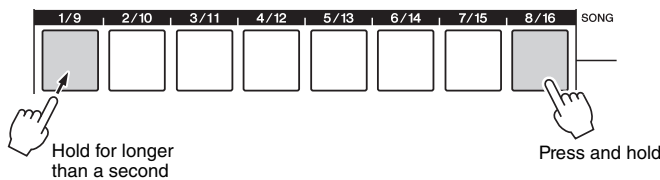

A confirmation message will appear on the display. Press [-/NO] to cancel the Song Clear operation. If the message doesn't appear, press the [REGIST/PART[MIXER]] button to call up "TR 1-8" or "TR 9-16," then try step 2 again.

- 3 Press the [+ / YES] button to clear the Song.

The clear-in-progress message will appear briefly on the display while the Song is being cleared.

Songs can also be cleared in the following way.

- 1 Press the [FILE MENU] button.
- 2 Press the category [◀] and [▶] buttons until "User Delete" appears.
- 3 Rotate the dial to select a Song.
- 4 Press the [EXECUTE] button.
A confirmation message will appear in the display.
- 5 Press the [+ / YES] button to clear the Song.

Track Clear—Deleting a Specified Track From a User Song

This function lets you delete a specified track from a User Song.

- 1 Press the [USER] button and rotate the dial to select the desired Song (001 to 005), then press the [EXIT] button to return to the Main display.

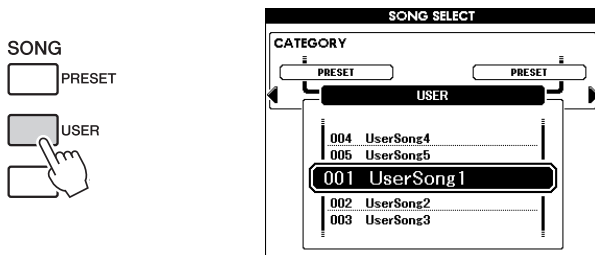

- 2 Press the [REGIST/PART [MIXER]] button a few times to call up the desired item, “TR 1-8” or “TR 9-16.”



- 3 Press and hold the desired track button ([1/9] to [8/16]) for longer than a second.

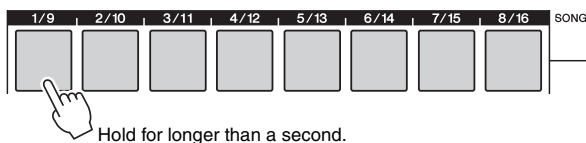

A confirmation message will appear on the display. Press [-/NO] to cancel the Track Clear operation.

- 4 Press the [+ / YES] button to clear the track.
The clear-in-progress message will appear briefly on the display while the track is being cleared.

If you want to play music in your favorite Style, but you're not sure how to select the best Voice and Style for the type of music you want to play, simply select the appropriate Style from the Music Database. The panel settings will automatically be adjusted for the ideal combination of sounds and Style!

1 Press the [MDB] button.

The music database selection display will appear.

The currently selected category name, MDB number and name will be highlighted.

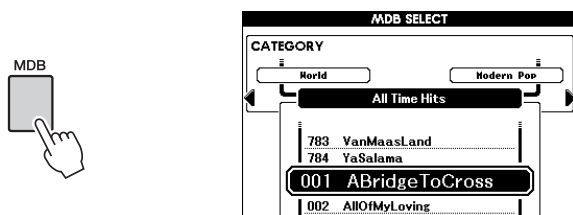

2 Select the Music Database which matches the music style or type you want to play.

Referring to the Music Database List in the separate Data List, use the dial to select a music database. Select one that matches the image of the song you intend to play.

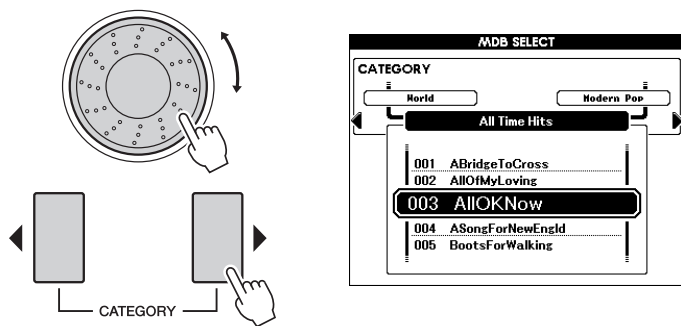

NOTE 1

- Music Database (MDB) files on or loaded from a USB flash memory connected to the instrument can be selected and used in the same way as the internal Music Databases. File load instructions are provided on page 59.

3 Play the chords with your left hand and the melody with your right.

The Style will start playing when you play a left-hand chord to the left of the split point (page 30). Refer to page 32 for information about playing chords.

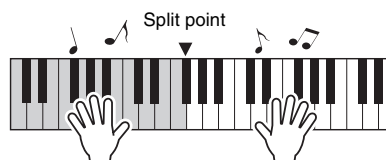

NOTE 1

- You can check the assigned Voice and Style at this point by pressing the [EXIT] button to return to the Main display.

4 Press the [▶/■] button to stop playback.

6 Mixer

This instrument has a Mixer feature that lets you control on/off settings for each track, or adjust the Volume, Pan, Reverb Level and Chorus Level for each track during Song or Style playback. By editing these parameters, you can change the feeling of the Song or Style. Tracks [1]–[16] can be set for Song playback, and [9]–[16] for Style.

- 1 Select the Style or Song.
- 2 Press and hold the [REGIST/PART [MIXER]] button for longer than a second so that the Mixer display appears.

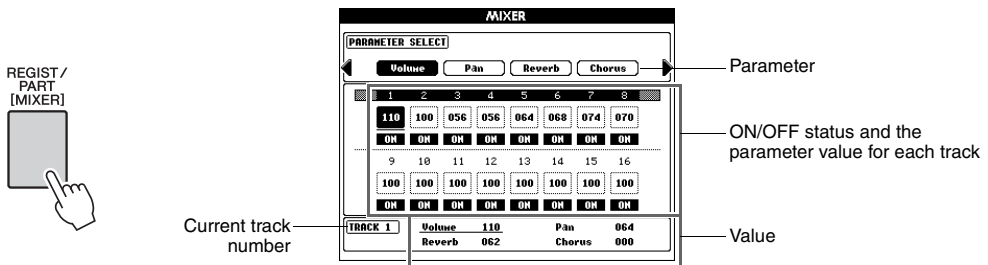

Current track and its value are highlighted on the display. In this example, Track 1 is selected, set to ON, and its volume is set to 110.

- 3 When in the Song mode, press the [REGIST/PART [MIXER]] button to select the desired track group, 1–8 or 9–16. The button toggles between tracks 1–8 and 9–16. In the Style mode, tracks 9–16 are selected automatically.

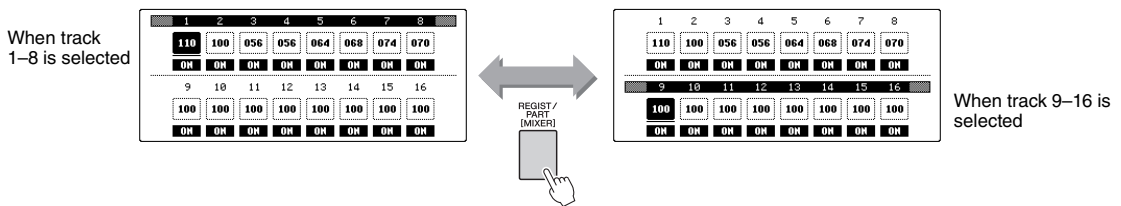

- 4 Select the desired Track by pressing the corresponding button.

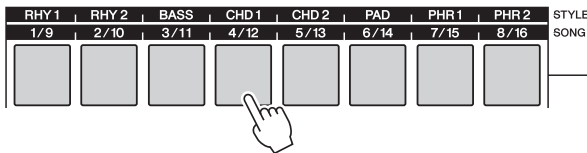

- 5 Set the ON/OFF status of the selected track. Pressing the Track button pressed in step 4 toggles between ON (Green) and OFF.

- 6 Select the desired parameter by using the CATEGORY [◀] and [▶] buttons and change the parameter value with the dial.

6. Mixer

Volume	Determines the Part volume.	Range: 0–127
Pan	Determines the Pan position.	Range: 0–64–127
Reverb Level	Determines the Reverb depth.	Range: 0–127
Chorus Level	Determines the Chorus depth.	Range: 0–127

7 Repeat steps 4–6 to set other tracks if necessary.

8 Save the settings here as Style data or Song data.

You can select either USB flash memory or internal memory as the save destination. If you want to save to the USB flash memory, connect the USB flash memory to the USB TO DEVICE terminal.

- 1 Press the [EXECUTE] button to call up the STYLE CREATOR display or the SONG EDIT display for saving the data.
- 2 Select the save destination.
Pressing the [USB] button alternates the save destination between USB flash memory and internal memory. If you want to save to USB flash memory, select “Save To USB”; if you want to save to internal memory, select “Save To USER” in the display.
A default file name will automatically be created.
- 3 Press the [EXECUTE] button.
- 4 (Only in the SONG EDIT display) Change the file name as necessary, then press the [EXECUTE] button again.
For instructions on naming, refer to step 4 on page 57.
- 5 Press the [+ / YES] button to execute the save operation.

NOTE 1

- The settings in the Preset Song cannot be saved.

NOTE 2

- For details, refer to the “Style Creator” chapter or “Song Edit” chapter in the Reference Manual.

9 Press the [EXIT] button to return to the Main display.

The **Registration Memory** feature lets you memorize your favorite panel settings for easy recall whenever they are necessary. Up to 64 complete setups (8 Banks of 8 set-ups each) can be memorized.

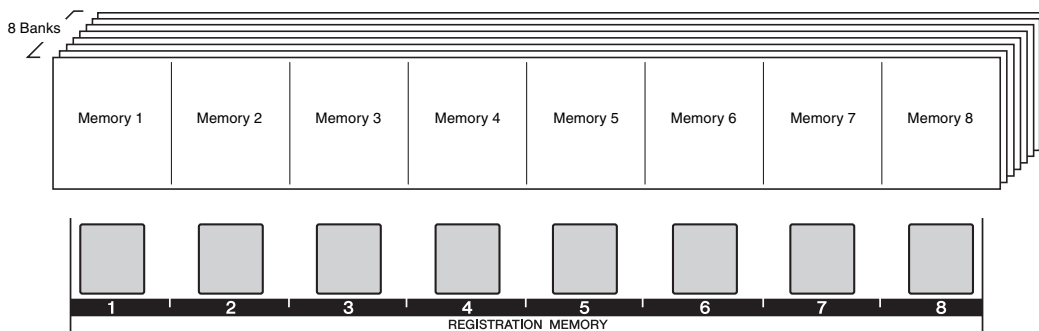

When using Registration Memory, press the [REGIST/PART [MIXER]] button repeatedly until “REGIST” is highlighted at the right bottom of the Main display. With this operation, the eight buttons on the center of the panel can be used as the Registration Memory buttons.

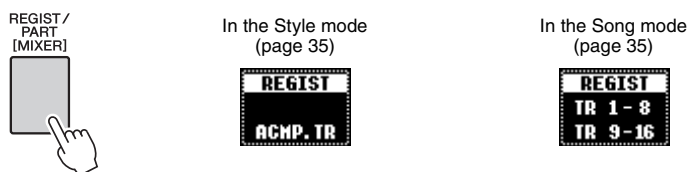

The color is used to indicate the current status of the individual Registration Memory [1] – [8].

- Unlighted..... Contains no data.
- Lit in Green Contains data and not selected.
- Lit in Red Contains data and currently selected.

Panel Settings that can be memorized to the Registration Memory

• Style settings*

Style number, Auto Accompaniment ON/OFF, Split Point, Sections, Style Volume, Chord Fingering, Reverb Type, Chorus Type

• Tempo

• Voice settings

Main Voice settings: Voice number, Volume, Octave, Pan, Reverb Level, Chorus Level, DSP Level, Dry Level

Dual Voice settings: Dual ON/ OFF, Voice number, Volume, Octave, Pan, Reverb Level, Chorus Level, DSP Level, Dry Level

Left Voice settings: Left ON/OFF, Voice number, Volume, Octave, Pan, Reverb Level, Chorus Level, DSP Level, Dry Level

Harmony settings: Harmony ON/OFF, Harmony Type, Harmony Volume
Sustain ON/OFF, DSP ON/OFF, DSP Type, Pitch Bend Range, Upper Octave

• Transpose

• Scale

Scale, Scale Tune, Base Note, Part Select

*Style number, Auto Accompaniment ON/OFF, Sections, Style Volume and Chord Fingering in the Style settings cannot be memorized and called up in the Song mode.

Memorizing the Panel Settings

- 1 Make the panel settings (page 49) as desired.
- 2 Press the REGIST BANK [-]/[+] buttons to select the desired Bank.
As shown below, the REGIST display appears. The dial can also be used to change values.

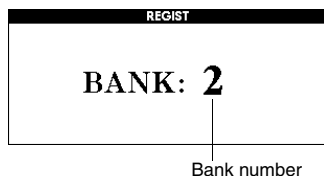
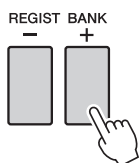

NOTE 1

- The panel settings cannot be memorized during Song playback.

- 3 While holding the [MEMORY] button, press one of the unlit Registration Memory [1]–[8] buttons.
When the REGIST is highlighted in the Main display, the pressed button lights in red, indicating that the panel settings have been memorized.

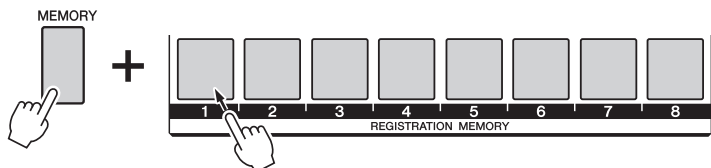

NOTICE

- If you press the lighted button that already contains data, the previous data will be replaced with the new one.
- Do not turn off the power during this operation, otherwise the data may be damaged or lost.

NOTE 1

- You can save the entire Registration Memory data (64 setups) to the USB flash memory as backup.

Recalling the Memorized Panel Settings

- 1 On the Main display, press the [REGIST/PART [MIXER]] button repeatedly until “REGIST” is highlighted (page 49).
- 2 Press the REGIST BANK [-]/[+] buttons to select the desired Bank.
As shown below, the REGIST display appears. The dial can also be used to change values.

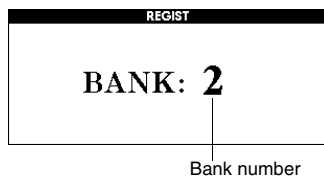
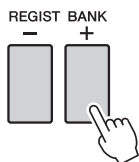

3 Press one of the green-lit Registration Memory [1]–[8] buttons.

The color of the pressed button will change from green to red, indicating that the memorized panel settings have been called up.

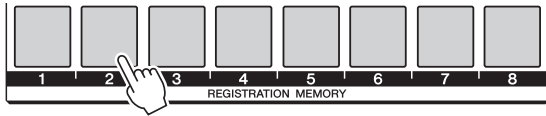
**NOTE 1**

- Harmony ON/OFF setting may not be recalled, or may be automatically turned off when the Chord Fingering type is set to "FullKeyboard."

Disabling Recall of Specific Items (Freeze)

Registration Memory lets you recall all the panel setups you made with a single button press. However, there may be times that you want certain items to remain the same, even when switching Registration Memory setups. For example, you may want to switch Voices or effect settings while keeping the same accompaniment Style. This is where the Freeze function comes in handy. It lets you maintain the settings of certain items and leave them unchanged, even when selecting other Registration Memory buttons.

1 Select the item to be "frozen."

Press and hold the [FREEZE] button for longer than a second to call up the Freeze Group Setting display. Use the dial to select the desired item from Style, Voice, Tempo, Transpose and Scale, then press the [EXECUTE] button. The on/off status will be highlighted, allowing you to change it.

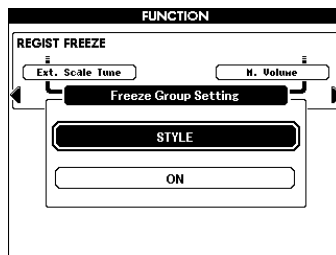
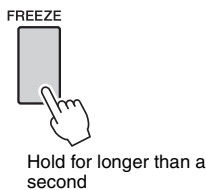
**2 Select "ON."**

Select "ON" for the item not to be recalled, or "OFF" for recall, then press the [EXECUTE] button. Since the item will be highlighted again for selection, repeat steps 1–2 (if desired), or press the [EXIT] button to return to the Main display.

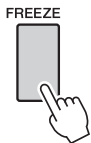
3 Turn the Freeze function on by pressing the [FREEZE] button.

Registration Clear—Deleting the Specified Registration Memory

- 1 On the Main display, press the [REGIST/PART [MIXER]] button repeatedly until “REGIST” is highlighted (page 49).
- 2 Press the REGIST BANK [-]/[+] buttons to select the desired Bank.
As shown below, the REGIST display appears. The dial can also be used to change values.



- 3 Press and hold one of the lit Registration Memory [1]–[8] buttons.
A confirmation message will appear in the display.

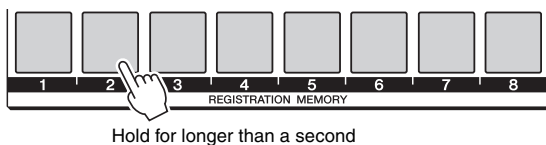

To cancel the Clear operation, press the [-/NO] button at this message.

- 4 Press the [+ /YES] button to clear the Registration Memory pressed in Step 3.
The clear-in-progress message will appear briefly on the display while the Registration Memory is being cleared.

Backup Data and Memory Data

The following settings are always backed up, and are maintained even when the power is turned off. If you want to initialize the settings (restoring the factory programmed settings), use the Initialize operation as explained below.

Backup data

- Registration memory
- Auto Fill In On/Off
- Touch ON/OFF
- Sustain ON/OFF
- File save destination in the STYLE CREATOR/SONG EDIT displays
- Following parameters in the Function display:
 - Tuning, Split point, Touch sensitivity, TG mode, Style volume, Song volume, Metronome volume, Demo cancel, Language, Master EQ type, Chord fingering, Auto Power Off, Freeze, Demo Group, Demo Play Mode

Memory data

- User Song (recordings of your own performances, or Songs loaded or transferred from the external device)
- User Style (Created by Style Creator function, or Styles loaded or transferred from the external device)
- User Music Database (loaded or transferred from the external device)

NOTE

- You can save the Backup data to your computer, by using the Musicsoft Downloader (MSD) software. For details, refer to the Reference Manual.

Initialization

This function erases Backup data or Memory data independently and restores the initial default settings. The following initialization procedures are provided. Expansion contents transferred to internal flash memory by installing the expansion pack cannot be deleted by this function.

Backup Clear

To clear backup data, turn the power on by pressing the [⏻] (STANDBY/ON) switch while holding the highest white key on the keyboard.

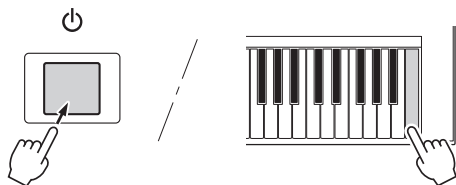

NOTE

- The Language setting cannot be restored to the default setting. Language can be changed in the Function display (page 12).

Memory Clear

To clear Memory data, turn the power on by pressing the [⏻] (STANDBY/ ON) switch while simultaneously holding the highest white key on the keyboard and the three highest black keys.

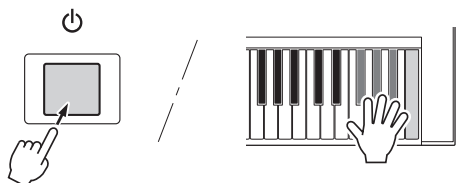

NOTICE

- When you execute the Clear operation, any User Songs, User Styles or User MDBs you have purchased will also be cleared. Be sure to save any important data to a USB flash memory or a computer.

9 Using USB Flash Memory

When a USB storage device is inserted in this instrument's USB TO DEVICE terminal, User Songs and User Styles created on the instruments and memorized settings can be saved to or loaded from the device individually.

Precautions when using the [USB TO DEVICE] terminal

This instrument features a built-in [USB TO DEVICE] terminal. When connecting a USB device to the terminal, be sure to handle the USB device with care. Follow the important precautions below.

NOTE

- For more information about the handling of USB devices, refer to the owner's manual of the USB device.

Compatible USB devices

- USB storage devices (flash memory, etc.)

The instrument does not necessarily support all commercially available USB devices. Yamaha cannot guarantee operation of USB devices that you purchase. Before purchasing a USB device for use with this instrument, please visit the following web page:

<http://download.yamaha.com/>

NOTE

- Other USB devices such as a computer keyboard or mouse cannot be used.

Connecting USB device

- When connecting a USB cable, use a cable no longer than 3 meters.
- When connecting a USB device to the [USB TO DEVICE] terminal, make sure that the connector on the device is appropriate and that it is connected in the proper direction.

NOTICE

- Though the instrument supports the USB 1.1 standard, you can connect and use a USB 2.0 storage device with the instrument. However, note that the transfer speed is that of USB 1.1.

Using USB Storage Devices

By connecting the instrument to a USB storage device, you can save data you've created to the connected device, as well as read data from the connected device.

The number of USB storage device to be used

One USB storage device can be connected to the [USB TO DEVICE] terminal.

Formatting USB storage media

When a USB storage device is connected or media is inserted, a message may appear prompting you to format the device/media. If so, execute the Format operation (page 56).

NOTICE

- The format operation overwrites any previously existing data. Make sure that the media you are formatting does not contain important data.

To protect your data (write-protect)

To prevent important data from being inadvertently erased, apply the write-protect provided with each storage device or media. If you are saving data to the USB storage device, make sure to disable write-protect.

Connecting/removing USB storage device

Before removing the media from the device, make sure that the instrument is not accessing data (such as in the Save, Delete and Format operations).

NOTICE

- Avoid frequently turning the power on/off to the USB storage device, or connecting/disconnecting the device too often. Doing so may result in the operation of the instrument "freezing" or hanging up. While the instrument is accessing data (such as during Save, Delete, Load and Format operations) or is mounting the USB storage device (shortly after the connection), do NOT unplug the USB connector, do NOT remove the media from the device, and do NOT turn the power off to either device. Doing so may corrupt the data on either or both devices.

File Control Display

USB flash memory operations, such as Save and Load can be performed from the FILE CONTROL display.

- 1 Connect a USB flash memory to the USB TO DEVICE terminal, being careful to insert it in the proper direction.

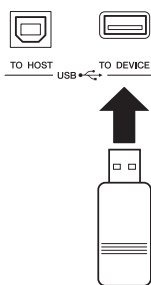

- 2 Check that the “CONNECT” message is shown in the upper right corner of the Main display.

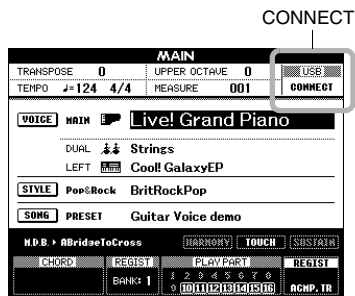

- 3 Press the [FILE MENU] button to call up the FILE CONTROL display.

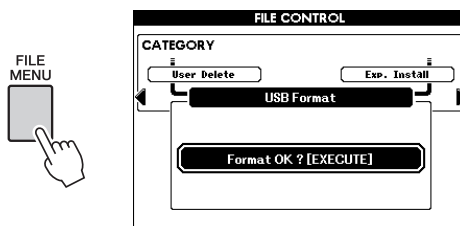

If the file control functions are accessed while an unformatted USB flash memory is connected to the instrument, the “Format” function will automatically be selected. Format a USB flash memory following the instructions presented on page 56.

- 4 Perform operations such as Save and Load, as desired.

For details, refer to pages 56–60.

A message (information or confirmation dialog) sometimes appears in the display to facilitate operation. Refer to the “Messages” section on page 67 for an explanation of each message.

NOTE

- No sound will be produced if you play the keyboard while the FILE CONTROL display is showing. Also, in this state only buttons related to file functions will be active.

NOTE

- You cannot access the FILE CONTROL display in any of the following cases:
 - During Style or Song playback/recording.
 - When “CONNECT” is not shown in the Main display, even though a USB flash memory is connected to the USB TO DEVICE terminal.

Formatting USB Flash Memory

A new USB flash memory must be formatted before it can be used by this instrument.

NOTICE

- If you format a USB flash memory that already contains data, all of the data will be erased. Be careful not to erase important data when using the format function.

1 Call up the FILE CONTROL display (page 55).

2 Use the CATEGORY [◀] and [▶] buttons to select “USB Format.”

The display prompts you for confirmation.

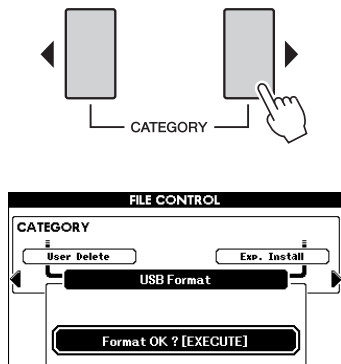

3 Press the [EXECUTE] button and the display prompts you for confirmation.

You can press the [-/NO] button at this message to cancel the operation.

4 Press the [EXECUTE] button again, or the [+ /YES] button to execute the format operation.

NOTICE

- Once the format-in-progress message appears in the display, the operation cannot be canceled. Never turn off the power or remove the USB flash memory during this operation. Doing so could result in damage to the data.

5 When the operation is complete, a “Completed” message appears briefly, then returns to the display of step 2. Press the [EXIT] button to exit from the FILE CONTROL display.

NOTE

- If the USB flash memory has been write-protected, an appropriate message will appear in the display and you will not be able to execute the operation.

Saving the Registration Memory

All 64 setups memorized to the Registration Memory can be saved to the USB flash memory as a single file (extension: usr).

1 Make sure that a formatted USB flash memory has been properly connected to the USB TO DEVICE terminal, then call up the FILE CONTROL display (page 55).

2 Use the CATEGORY [◀] and [▶] buttons to select “Regist Save.”

A default file name will automatically be created.

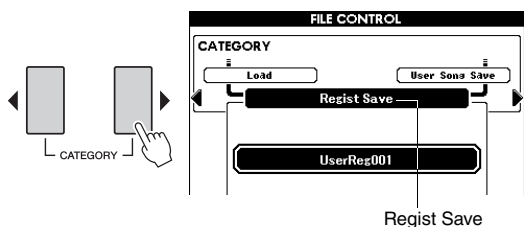

To Overwrite an Existing File

If you want to overwrite a file that already exists in USB flash memory, use the dial or the [-/NO] and [+ /YES] buttons to select the file, then go to step 5.

NOTE

• If there is not enough capacity left in the USB flash memory, a message will appear in the display and you cannot save the data. Erase unnecessary files from the USB flash memory to make more memory available (page 60).

3 Press the [EXECUTE] button.

A cursor will appear below the first character in the file name.

4 Change the file name as necessary.

- The [1] button moves the cursor to the left, and the [2] button moves it to the right.
- Use the dial to select a character for the current cursor location.
- The [8] button deletes the character at the cursor location.

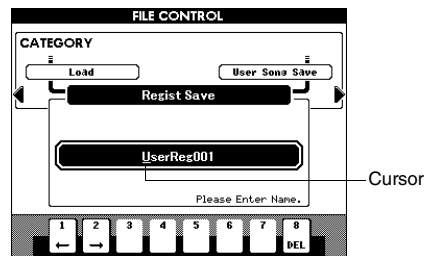
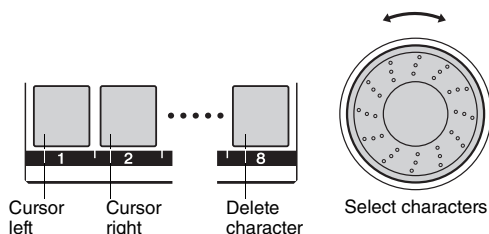

5 Press the [EXECUTE] button.

The display prompts you for confirmation. You can cancel the save operation at this message by pressing the [-/NO] button.

6 Press the [EXECUTE] button again, or the [+ /YES] button to execute the save operation.

NOTICE

- The amount of time it may take to perform the save operation depends on the status of the USB flash memory. Even if this takes a long time, never turn off the power or remove the USB flash memory during this operation. Doing so could result in damage to the data.

NOTE

- If an existing file name is specified, the display prompts you for confirmation. Press [EXECUTE] or [+ /YES] if it is OK to overwrite the file, or [-/NO] to cancel.

7 When the operation is complete, a “Completed” message appears briefly, then returns to the display of step 2. Press the [EXIT] button to exit from the FILE CONTROL display.

The Registration Memory file will be saved to the USER FILE folder in the USB flash memory.

NOTE

- Perform the Load operation (page 59) if you want to recall the Registration Memory file on the USB flash memory to the instrument.

Saving a User Song or User Style

This operation saves one of the User Songs (001–005) as a SMF File (extension: mid), or one of the User Styles as a Style File-formatted file (extension: sty).

What is SMF (Standard MIDI File)?

The SMF (Standard MIDI File) format is one of the most common and widely compatible sequence formats used for storing sequence data. There are two variations: Format 0 and Format 1. A large number of MIDI devices are compatible with SMF Format 0, and most commercially available MIDI sequence data is provided in SMF Format 0.

1 Make sure that a formatted USB flash memory has been properly connected to the USB TO DEVICE terminal, then call up the FILE CONTROL display (page 55).

2 Use the CATEGORY [◀] and [▶] buttons to select “User Song Save” or “User Style Save.”

The Source File—a user Song name or a user Style name in the instrument—will be highlighted.

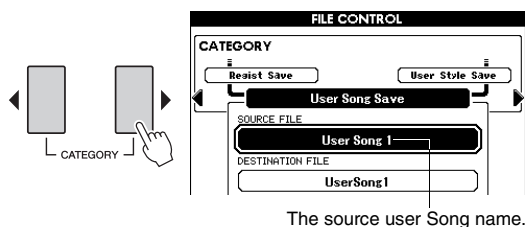

3 Use the dial to select the source user Song or Style.

Press the [+ / YES] and [- / NO] buttons simultaneously to select the first user Song or Style.

4 Press the [EXECUTE] button.

The Destination Song or Style will be highlighted with the same name as that of the Source.

To Overwrite an Existing File

If you want to overwrite a file that already exists on the USB flash memory, use the dial or the [+ / YES] and [- / NO] buttons to select the file, then go to step 7.

5 Press the [EXECUTE] button.

A cursor will appear below the first character in the file name.

6 Change the Destination file name as necessary.

For details, refer to step 4 on page 57.

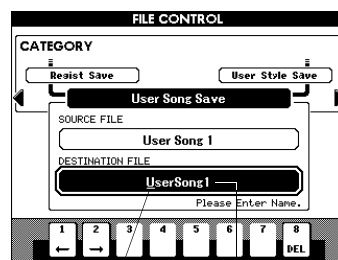

7 Press the [EXECUTE] button.

The display prompts you for confirmation. You can cancel the save operation at this message by pressing the [- / NO] button.

8 Press the [EXECUTE] button again, or the [+ / YES] button to execute the save operation.

NOTICE

- The amount of time it may take to perform the save operation depends on the status of the USB flash memory. Even if this takes a long time, never turn off the power or remove the USB flash memory during this operation. Doing so could result in damage to the data.

9 When the operation is complete, a “Completed” message appears briefly, then returns to the display of step 2. Press the [EXIT] button to exit from the FILE CONTROL display.

The file will be saved to the USER FILE folder in the USB flash memory.

NOTE

- If an existing file name is specified, the display prompts you for confirmation. Press [EXECUTE] or [+ / YES] if it is OK to overwrite the file, or [- / NO] to cancel.

NOTE

- Perform the Load operation (page 59) if you want to recall the User Song or User Style saved on the USB flash memory to the instrument.

Loading a File

Registration files (extension: usr), Style files (extension: sty), Song files (extension: mid) and MDB files (extension: MFD) saved to the USER FILE folder in the USB flash memory can be loaded to the instrument individually.

NOTICE

- If the same file name already exists in the instrument, it will be overwritten and erased. Especially, loading the Registration file will erase all the existing 64 setups. Keep this in mind when loading a file.

- 1 Make sure that a formatted USB flash memory has been connected to the USB TO DEVICE terminal, then call up the FILE CONTROL display (page 55).
- 2 Use the CATEGORY [◀] and [▶] buttons to select “Load.”

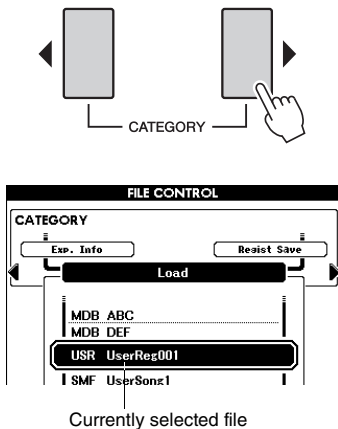

- 3 Use the dial to select the file (Registration, Style, Song or MDB) you want to load.
- 4 Press the [EXECUTE] button. The display prompts you for confirmation. You can cancel the load operation at this message by pressing the [-/NO] button.
- 5 Press the [EXECUTE] button again, or the [+ /YES] button to execute the load operation.

NOTICE

- Once the load-in-progress message appears in the display, the operation cannot be canceled. Never turn off the power or remove the USB flash memory during this operation. Doing so may corrupt the data on the device.

- 6 When the operation is complete, a “Completed” message appears briefly, then returns to the display of step 2. Press the [EXIT] button to exit from the FILE CONTROL display.

- 7 Check that the file is properly loaded.

- When a Registration file is loaded, press one of the Registration Memory buttons to call up the panel settings.
- When a Music Database file is loaded, press the [MDB] button then confirm that the loaded file name is added on the display.
- When a Song file is loaded, press the [USER] button then confirm that the loaded file name is added on the display.
- When a Style file is loaded, press the [EXPANSION/USER] button in the STYLE section then confirm the loaded file name is added on the display.

NOTE

- When loading a Song or Style, you should set whether the DSP Effect is used for the keyboard performance, or for Song/Style playback. This is because the DSP Effect can be used only for either part. Set the “TG Mode” parameter on the Function display.

Deleting Data from USB Flash Memory

This procedure deletes Registration files, Song files and Style files in the USB flash memory. The files to be deleted must be located inside the “USER FILES” folder on the USB flash memory.

- 1 **Make sure that a formatted USB flash memory has been connected to the USB TO DEVICE terminal, then call up the FILE CONTROL display (page 55).**
- 2 **Use the CATEGORY [◀] and [▶] buttons to select “USB Delete.”**

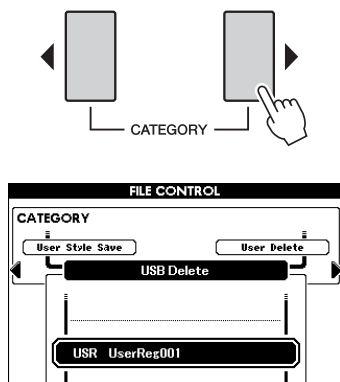

- 3 **Select the file you want to delete.**
You can press the [+ / YES] and [- / NO] buttons simultaneously to select the first Song or registration file on the USB flash memory.
- 4 **Press the [EXECUTE] button.**
The display prompts you for confirmation. You can cancel the delete operation at this message by pressing the [- / NO] button.
- 5 **Press the [EXECUTE] button again, or the [+ / YES] button, to execute the delete operation.**

NOTICE

- Once the delete-in-progress message appears in the display, the operation cannot be canceled. Never turn off the power or remove the USB flash memory during this operation. Doing so could result in damage to the data.

- 6 **When the operation is complete, a “Completed” message appears briefly, then returns to the display of step 2. Press the [EXIT] button to exit from the FILE CONTROL display.**

NOTE

- If the USB flash memory has been write-protected, an appropriate message will appear in the display and you will not be able to execute the operation.

User Delete

This procedure deletes the selected User Songs, User Styles and User MDBs in the instrument’s internal memory.

- 1 Press the [FILE MENU] button.
- 2 Use the CATEGORY [◀] and [▶] buttons to locate “User Delete.”
- 3 Follow the procedure described above from step 3.

10 Expanding Voices and Styles

(Installing to the Expansion Category)

Installing an Expansion Pack (Extension: yep) lets you add a variety of optional Voices and Styles to each Expansion category. The installed Voices and Styles can be selected like Preset Voices and Styles, allowing you to expand your music performance and creation possibilities.

Expansion Packs as sample can be downloaded from the PSR-S650 page within Yamaha Web Site (<http://www.yamaha.com/>). Depending on your locale, in addition, Expansion Packs may be available for expanding Voices and Styles unique or native to your locale.

NOTICE

- Installing an Expansion Pack will erase the previously existing Expansion Pack data in the instrument. We recommend that you keep a copy of the Expansion Pack data in a separate USB flash memory or a computer.

NOTE

- The Expansion Pack to be installed must be located inside the "USER FILES" folder on the USB flash memory.

NOTE

- Encrypted Expansion Packs, Packs larger than approx. 16 MB, or Packs for instrument other than the PSR-S650 cannot be used.

1 Make sure that a formatted USB flash memory has been connected to the USB TO DEVICE terminal, then call up the FILE CONTROL display (page 55).

2 Use the CATEGORY [◀] and [▶] buttons to select "Expansion Pack Installation."

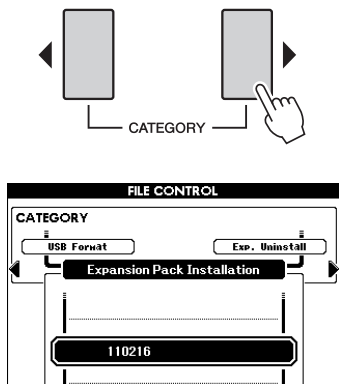

3 Use the dial to select the Expansion Pack you want to install.

You can confirm the information of the selected file by pressing the [START/STOP] button. After confirming, press the [EXIT] button to return to the display of step 2.

4 Press the [EXECUTE] button

The display prompts you for confirmation. You can cancel the installation operation at this message by pressing the [-/NO] button.

5 Press the [EXECUTE] button again, or the [+ /YES] button, to execute the installation.

While the Expansion Pack is being installed, a popup window will indicate the progress.

6 When installation is completed, a message will appear prompting you to turn off the power and on again. Turn the power off, then back on.

7 Press the [EXPANSION] button in the VOICE section, select the installed Voice, then play the keyboard.

8 Press the [EXPANSION/USER] button in the STYLE section, select the installed Style then play the selected Style.

About Song, Style or Registration Memory including Expansion Voices and Styles

Since installing the Expansion Pack will erase any Voices and Styles previously existing in the Expansion category, please keep in mind the following points.

- Any User Song/Style data using the previous Expansion Voices will produce unexpected sound.
- Unexpected Voices and Styles will be called up, or no data will be called up from the Registration Memory you've created using the previous Expansion Voices or Styles.
- Any User Song using the previous Expansion Voices or Styles will produce unexpected sound.

Because of the above points, make sure to record the name of the installed Expansion Pack when you create original data, such as User Songs using Expansion Voices and Styles.

Confirm the Information of the Expansion Pack

You can confirm the information of the currently installed Expansion Pack on the display.

- 1 Press the [FILE MENU] button.
- 2 Use the CATEGORY [◀] and [▶] buttons to select “Expansion Pack Information.”

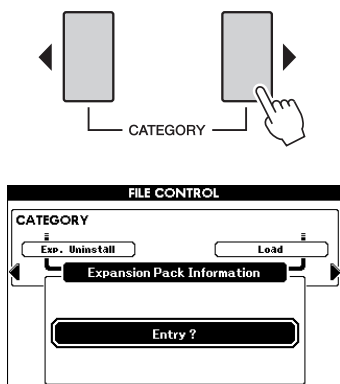

- 3 Press the [EXECUTE] button or the [START/STOP] button to call up the information of the Expansion Pack.

Deleting the Expansion Voice or Style

This operation deletes all the installed Voices or Styles in the Expansion category, and initializes the corresponding memory area.

NOTICE

- Any User Song, Style and Registration Memory using the previous Expansion Contents will produce the unexpected sound.

- 1 Press the [FILE MENU] button.
- 2 Use the CATEGORY [◀] and [▶] buttons to select “Expansion Pack Uninstallation.”

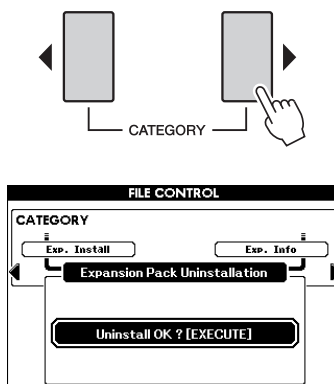

- 3 Press the [EXECUTE] button
The display prompts you for confirmation. You can cancel the installation operation at this message by pressing the [-/NO] button.
- 4 Press the [EXECUTE] button again, or the [+ /YES] button to execute the un-installation operation.
- 5 When uninstallation is completed, a message will appear prompting you to turn off the power and on again. Turn the power off, then back on.
The installed area is restored to the initial factory defaults when the power is turned on.

11 Connecting to a Computer

Connecting the instrument to a computer via a USB cable offers the following useful possibilities:

- The instrument's performance data can be recorded with DAW software on the computer, and the performance data from the computer can be played on the instrument, since the connection allows you to transmit/receive MIDI messages to/from a computer.
- A file such as a Song or a Style file can be transferred between the computer and instrument with the Musicsoft Downloader application. For details, refer to the Reference Manual.

MIDI

MIDI (Musical Instrument Digital Interface) is a world-standard interface for communication between electronic musical instruments and music devices or computers.

There are two ways to connect the instrument to a computer:

■ Using the function included in your computer's operating system

The instrument uses the generic MIDI function included in your computer's operating system, so there's no need to install any extra driver software.

Operating System (OS):

Windows XP Professional (SP3)/XP Home Edition (SP3), Windows Vista, Windows 7, Mac OS X Version 10.5–10.6.x

1 Turn off the power of the instrument, and turn on the power of the computer.

Quit any open application software on the computer.

2 Connect the instrument and the computer via a USB cable.

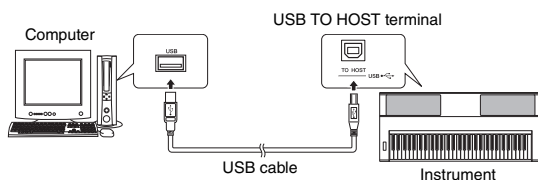

3 Turn on the power of the instrument.

The computer will automatically be set to enable MIDI communication with the instrument.

■ Using Yamaha Standard USB-MIDI driver

When data communication is unstable or some problem occurs even though you've executed the above instructions, download the Yamaha Standard USB-MIDI driver from the following URL then install it to your computer.

<http://download.yamaha.com/>

For instructions on installation, refer to the Install Guide included in the package file.

Operating System (OS):

For details about OS for Yamaha Standard USB-MIDI driver, visit the URL above.

NOTE

- MIDI settings such as the Local Control on/off setting or the MIDI transmit/receive channel settings can be set in the Function display. For details, refer to the Reference Manual.

Precautions when using the USB TO HOST terminal

When connecting the computer to the USB TO HOST terminal, make sure to observe the following points. Failing to do so risks freezing the computer and corrupting or losing the data. If the computer or the instrument freezes, restart the application software or the computer OS, or turn the power to the instrument off then on again.

NOTICE

- Use an AB type USB cable of less than about 3 meters.
- Before connecting the computer to the USB TO HOST terminal, exit from any power-saving mode of the computer (such as suspend, sleep, standby).
- Before turning on the power to the instrument, connect the computer to the USB TO HOST terminal.
- Execute the following before turning the power to the instrument on/off or plugging/unplugging the USB cable to/from the USB TO HOST terminal.
 - Quit any open application software on the computer.
 - Make sure that data is not being transmitted from the instrument. (Data is transmitted only by playing notes on the keyboard or playing back a song.)
- While the computer is connected to the instrument, you should wait for six seconds or more between these operations: (1) when turning the power of the instrument off then on again, or (2) when alternately connecting/disconnecting the USB cable.

■ MIDI Setup

The MIDI settings can be set individually in the "MIDI" category of the Function display. For details, refer to the Reference Manual.

Troubleshooting

Problem	Possible Cause and Solution
Power suddenly and unexpectedly turns off.	This is normal and the Auto Power Off function may have been activated (page 10). If desired, disable the Auto Power Off function.
When the instrument is turned on or off, a popping sound is temporarily produced.	This is normal and indicates that the instrument is receiving electrical power.
When using a mobile phone, noise is produced.	Using a mobile phone in close proximity to the instrument may produce interference. To prevent this, turn off the mobile phone or use it further away from the instrument.
There is no sound even when the keyboard is played or when a song or style is being played back.	Check that nothing is connected to the PHONES/OUTPUT jack on the rear panel. When a set of headphones is plugged into this jack, no sound is output.
	Is "Local Control" set to ON? Make sure "Local Control" is set to ON in the Function display.
	Is the FILE CONTROL display showing? The instrument's keyboard, etc., will not produce any sound while the FILE CONTROL display is showing. Press the [EXIT] button to return to the Main display.
The style or song does not play back when the [START/STOP] button is pressed.	Is "External Clock" set to OFF? Make sure "External Clock" is set to OFF in the Function display.
The style does not sound properly.	Make sure that the "Style Volume" is set to an appropriate level in the Function display.
	Is the split point set at an appropriate key for the chords you are playing? Set the split point at an appropriate key in the Function display.
	Is the [ACMP] button lit? If it is not lit, press the [ACMP] button so it lights.
No rhythm accompaniment plays when the [START/STOP] button is pressed after selecting the BaroqueAir Style in the MOVIE & SHOW category.	This is not a malfunction. The BaroqueAir Style does not have a Rhythm part, so there is no rhythm sound for this Style. Also, this Style does not have a Fill-In section. The other parts will begin playing when you play a chord in the accompaniment.
Not all of the voices seem to sound, or the sound seems to be cut off.	The instrument is polyphonic up to a maximum of 64 notes. If the Dual voice or Split voice is being used and a Style or Song is playing back at the same time, some notes/sounds may be omitted (or "stolen") from the accompaniment or Song.
The footswitch (for sustain) seems to produce the opposite effect. For example, pressing the footswitch cuts off the sound and releasing it sustains the sounds.	The polarity of the footswitch is reversed. Make sure that the footswitch plug is properly connected to the SUSTAIN jack before turning on the power.
The sound of the voice changes from note to note.	This is normal. The AWM tone generation method uses multiple recordings (samples) of an instrument across the range of the keyboard; thus, the actual sound of the voice may be slightly different from note to note.
The Demo display is shown in Japanese, and/or there are Japanese characters in the display messages.	Make sure the Language setting in the Function display is set to English. (See page 12)
The ACMP indicator does not appear when the [ACMP] button is pressed.	Always press the desired style category button first when you are going to use any Style-related function.
There is no harmony sound.	The Harmony effects (01–26) behave differently according to their type. Types 01–10 and 13 function when Style playback is on, chords are played in the accompaniment range of the keyboard, and a melody is played in the right-hand range. Types 15–26 will function whether Style playback is on or off. For types 23–26 you need to play two notes at the same time.
The "OVER CURRENT" message is shown and the USB device does not respond.	Communication with the USB device has been shut down because of over-current to the USB device. Disconnect the device from the USB TO DEVICE terminal, then turn the power of the instrument off and on again.

Panel Button Chart

The below chart lists the buttons/controllers on the panel and the corresponding displays that are called up. Numbers at the left end correspond to the ones in “Panel Controls and Terminals” (page 8). “●” indicates that the detailed information is described in the Reference Manual (downloadable from website).

No.	Button/Controller	*Pressing for longer than a second	Display called up via the Button	Page	Reference Manual
①	[⏻] (Standby/On) switch		MAIN	11	
②	MASTER VOLUME control		—	11	
③	[DEMO] button		DEMO display	37	
		*	FUNCTION - DEMO - Demo Group	37	●
④	[SONG MODE] button		—	35	
⑤	SONG buttons				
	[PRESET]		SONG SELECT - PRESET	35	
	[USER]		SONG SELECT - USER	35	
	[SCORE]		Score of the current Song	38	
⑥	[USB] button		LYRICS	38	
			SONG SELECT - USB (when the [SONG MODE] is turned on)	37	
⑦	[REC] button		STYLE SELECT - USB (when the [SONG MODE] is turned off)	33	
			MAIN (when the [SONG MODE] is turned on)	40	
		*	STYLE CREATOR (when the [SONG MODE] is turned off)	—	●
			SONG EDIT (when the [SONG MODE] is turned on)	—	●
⑧	STYLE buttons [POP & ROCK]-[EXPANSION/USER]		STYLE SELECT	29	
⑨	STYLE CONTROL buttons				
	[OTS LINK]		—	34	
	[AUTO FILL IN]		—	30	●
	[ACMP]		—	29	
		*	FUNCTION - OVERALL - Chord Fingering	—	●
	[INTRO [I]-[III]]		—	31	●
	[MAIN VARIATION [A]-[D]]		—	31	●
	[ENDING/rit. [I]-[III]]		—	31	●
	[SYNC STOP]		—	33	
	[SYNC START]		—	30	
[START/STOP]		—	30		
⑩	SONG CONTROL buttons				
	[◀◀]		—	36	
	[▶▶]		—	36	
	[A ⇌ B]		—	39	
	[III]		—	36	
	[▶/■]		—	36	
⑪	TRANPOSE buttons		TRANPOSE	20	
⑫	METRONOME buttons		—	27	
		*	FUNCTION - METRONOME - Time Signature	27	●
⑬	TEMPO buttons				
	[+] and [-] [TAP TEMPO]		TEMPO TEMPO	34 34	
⑭	REGISTRATION MEMORY-related buttons				
	REGIST BANK [-] and [+]		—	50	
	[FREEZE]		—	51	
		*	FUNCTION - REGIST FREEZE	51	●
	[MEMORY]		—	50	
⑮	REGISTRATION MEMORY/SONG Track/STYLE Track buttons		In the Song mode: REGIST → TR 1-8 → TR 9-16 → REGIST → ... In the Style mode: REGIST → ACMP, TR → REGIST → ...	49	
	[REGIST/PART [MIXER]]		MIXER	47	
		*	—	49	
	REGISTRATION MEMORY [1]-[8]/STYLE Track/SONG Track [1/9]-[8/16]		—	49	
⑯	Display and related controls				
	[EXIT]		MAIN	13	
	Dial		—	14	
	[-/NO] and [+/YES]		—	14	
	CATEGORY [◀] and [▶] buttons		—	14	
	[EXECUTE]		—	15	
⑰	[MDB] button		MDB SELECT	46	
⑱	[FILE MENU] button		FILE CONTROL - USB Format	55, 56	
		+ CATEGORY [▶]	FILE CONTROL - Load	59	
		+ CATEGORY [▶]	FILE CONTROL - Regist Save	57	
		+ CATEGORY [▶]	FILE CONTROL - Song Save	58	
		+ CATEGORY [▶]	FILE CONTROL - Style Save	58	
		+ CATEGORY [▶]	FILE CONTROL - USB Delete	60	
		+ CATEGORY [▶]	FILE CONTROL - User Delete	60	
		+ CATEGORY [▶]	FILE CONTROL - Expansion Pack Installation	61	
		+ CATEGORY [▶]	FILE CONTROL - Expansion Pack Uninstallation	62	
		+ CATEGORY [▶]	FILE CONTROL - Expansion Pack Information	62	
			* FILE CONTROL - Expansion Pack Installation (When the USB flash memory is connected)	61	

No.	Button/Controller	*Pressing for longer than a second	Display called up via the Button	Page	Reference Manual
19	[FUNCTION] button		FUNCTION - VOLUME - Style Volume	—	●
	+ CATEGORY [▶]		FUNCTION - VOLUME - Song Volume	—	●
	+ CATEGORY [▶]		FUNCTION - OVERALL - Tuning	21	●
	+ CATEGORY [▶]		FUNCTION - OVERALL - Pitch Bend Range	20	●
	+ CATEGORY [▶]		FUNCTION - OVERALL - Split Point	—	●
	+ CATEGORY [▶]		FUNCTION - OVERALL - Touch Sensitivity	26	●
	+ CATEGORY [▶]		FUNCTION - OVERALL - Chord Fingering	—	●
	+ CATEGORY [▶]		FUNCTION - SCALE TUNE - Scale	22	●
	+ CATEGORY [▶]		FUNCTION - SCALE TUNE - Base Note	23	●
	+ CATEGORY [▶]		FUNCTION - SCALE TUNE - Scale Tune	23	●
	+ CATEGORY [▶]		FUNCTION - SCALE TUNE - Part Select	24	●
	+ CATEGORY [▶]		FUNCTION - SCALE TUNE - External Scale Tune	25	●
	+ CATEGORY [▶]		FUNCTION - REGIST FREEZE - Freeze Group Setting	51	●
	+ CATEGORY [▶]		FUNCTION - MAIN VOICE - Main Volume	—	●
	+ CATEGORY [▶]		FUNCTION - MAIN VOICE - Main Octave	—	●
	+ CATEGORY [▶]		FUNCTION - MAIN VOICE - Main Pan	—	●
	+ CATEGORY [▶]		FUNCTION - MAIN VOICE - Main Reverb Level	—	●
	+ CATEGORY [▶]		FUNCTION - MAIN VOICE - Main Chorus Level	—	●
	+ CATEGORY [▶]		FUNCTION - MAIN VOICE - Main DSP Level	—	●
	+ CATEGORY [▶]		FUNCTION - MAIN VOICE - Main Dry Level	—	●
	+ CATEGORY [▶]		FUNCTION - DUAL VOICE - Dual Volume	—	●
	+ CATEGORY [▶]		FUNCTION - DUAL VOICE - Dual Octave	—	●
	+ CATEGORY [▶]		FUNCTION - DUAL VOICE - Dual Pan	—	●
	+ CATEGORY [▶]		FUNCTION - DUAL VOICE - Dual Reverb Level	—	●
	+ CATEGORY [▶]		FUNCTION - DUAL VOICE - Dual Chorus Level	—	●
	+ CATEGORY [▶]		FUNCTION - DUAL VOICE - Dual DSP Level	—	●
	+ CATEGORY [▶]		FUNCTION - DUAL VOICE - Dual Dry Level	—	●
	+ CATEGORY [▶]		FUNCTION - LEFT VOICE - Left Volume	—	●
	+ CATEGORY [▶]		FUNCTION - LEFT VOICE - Left Octave	—	●
	+ CATEGORY [▶]		FUNCTION - LEFT VOICE - Left Pan	—	●
	+ CATEGORY [▶]		FUNCTION - LEFT VOICE - Left Reverb Level	—	●
	+ CATEGORY [▶]		FUNCTION - LEFT VOICE - Left Chorus Level	—	●
	+ CATEGORY [▶]		FUNCTION - LEFT VOICE - Left DSP Level	—	●
	+ CATEGORY [▶]		FUNCTION - LEFT VOICE - Left Dry Level	—	●
	+ CATEGORY [▶]		FUNCTION - EFFECT - Reverb Type	—	●
	+ CATEGORY [▶]		FUNCTION - EFFECT - Chorus Type	—	●
	+ CATEGORY [▶]		FUNCTION - EFFECT - DSP Type	—	●
	+ CATEGORY [▶]		FUNCTION - EFFECT - Master EQ Type	11	●
	+ CATEGORY [▶]		FUNCTION - HARMONY - Harmony Type	—	●
	+ CATEGORY [▶]		FUNCTION - HARMONY - Harmony Volume	—	●
+ CATEGORY [▶]		FUNCTION - PC - PC Mode	—	●	
+ CATEGORY [▶]		FUNCTION - MIDI - Local	—	●	
+ CATEGORY [▶]		FUNCTION - MIDI - External Clock	—	●	
+ CATEGORY [▶]		FUNCTION - MIDI - Keyboard Out	—	●	
+ CATEGORY [▶]		FUNCTION - MIDI - Style Out	—	●	
+ CATEGORY [▶]		FUNCTION - MIDI - Song Out	—	●	
+ CATEGORY [▶]		FUNCTION - MIDI - Initial Setup	—	●	
+ CATEGORY [▶]		FUNCTION - METRONOME - Time Signature Numerator	27	●	
+ CATEGORY [▶]		FUNCTION - METRONOME - Time Signature Denominator	28	●	
+ CATEGORY [▶]		FUNCTION - METRONOME - Bell	—	●	
+ CATEGORY [▶]		FUNCTION - METRONOME - Metronome Volume	—	●	
+ CATEGORY [▶]		FUNCTION - SCORE - Quantize	—	●	
+ CATEGORY [▶]		FUNCTION - SCORE - Right Part	—	●	
+ CATEGORY [▶]		FUNCTION - SCORE - Left Part	—	●	
+ CATEGORY [▶]		FUNCTION - DEMO - Demo Group	—	●	
+ CATEGORY [▶]		FUNCTION - DEMO - Demo Play Mode	—	●	
+ CATEGORY [▶]		FUNCTION - DEMO - Demo Cancel	—	●	
+ CATEGORY [▶]		FUNCTION - UTILITY - TG Mode	—	●	
+ CATEGORY [▶]		FUNCTION - UTILITY - Auto Power off	—	●	
+ CATEGORY [▶]		FUNCTION - LANGUAGE - Language	—	●	
		*	FUNCTION - SCALE TUNE - SCALE	22	●
20	ONE TOUCH SETTING buttons		—	34	●
21	VOICE buttons		VOICE SELECT (MAIN)	16	
	[PIANO]-[EXPANSION]				
22	VOICE CONTROL buttons				
	[LEFT]		—	17	
		*	VOICE SELECT (LEFT)	17	
	[DUAL]		—	17	
		*	VOICE SELECT (DUAL)	17	
	[HARMONY]		—	19	
		*	FUNCTION - HARMONY - Harmony Type	—	●
	[TOUCH]		—	26	
		*	FUNCTION - OVERALL - Touch Sensitivity	—	●
	[SUSTAIN]		—	19	
[DSP]		—	19		
	*	FUNCTION - EFFECT - DSP Type	—	●	
23	UPPER OCTAVE buttons		UPPER OCTAVE	20	
24	PITCH BEND wheel		—	20	

Messages

Message	Description
Opening	
Access Error!	The backup data was not recalled properly when turning on the power.
General	
Access Error!	Indicates the failure in reading or writing from/to the media, USB flash memory or the internal flash memory.
Media is not inserted.	Displayed when accessing the media while it is not inserted.
Media is not inserted. Please connect the USB flash memory to the USB TO DEVICE terminal, or change the save destination to internal memory.	Displayed when accessing the media while it is not inserted.
Mounting USB device.	Indicates that the media is currently unavailable since the instrument is recognizing the media.
The media is not formatted.	Indicates the inserted media has not been formatted.
The media is write-protected.	Indicates that the inserted media cannot be written since it is write-protected. Set to the write-protect switch to the "overwrite" position before use.
Media capacity is full.	Displayed when saving data cannot be executed since the media memory becomes full.
There are too many files.	Indicates that saving data cannot be executed since the total number of files exceeds the capacity.
The limit of the media has been reached.	Indicates that saving data cannot be executed since the folder/directory structure has become too complicated.
Data Error!	Displayed when the Song, Style or Expansion Pack contains illegal data, or when the information of the Expansion Pack is unusable because of the Language setting.
This function is not available now.	Indicates the designated function is not available since the instrument is executing another job.
Style Creator	
Do you clear original data?	This message asks you whether you want to create a completely new Style from scratch. If yes, press the [+ / YES] button, and press the [- / NO] button if not.
NOTICE Internal memory capacity may not be large enough. (Delete unwanted style data to make more memory available if necessary.) Remaining xxxKB	Internal memory capacity is not large enough to create the Style.
Internal memory capacity is not large enough to save data.	Style cannot be saved because available space in the internal memory is not sufficient.
Not enough memory for recording.	Any additional Style cannot be recorded because available space in the internal memory is not sufficient.
The style cannot be used.	The Style cannot be used because the source Style was not loaded properly.
Song Recording	
Memory Full	Displayed when the internal memory becomes full during recording.
Song Playback	
File too large. Loading is impossible.	Indicates that loading data cannot be executed since the file data is too large.
Song Edit	
Do you want to edit the song? Internal memory capacity may not be large enough. (Delete unwanted data to make more memory available if necessary.) Remaining xxxKB	Internal memory capacity may not be large enough to save the Song.

Message	Description
Score	
The song data is too large to be converted to notation.	Indicates that the score cannot be displayed since the Song data is too large.
The notation cannot be displayed, since this song is not allowed to display the notation.	The notation cannot be displayed, since this Song is not allowed to display the notation.
File Control	
Since the media is in use now, this function is not available.	Indicates that the file control function is currently unavailable since the media is being accessed.
File is not found.	Indicates there is no file.
Save data is not found.	Displayed when the data to be saved doesn't exist.
File information area is not large enough.	Indicates that saving data in the media cannot be executed since the total number of files have become too many.
Data was not found.	Displayed when the data to be uninstalled or confirmed the information doesn't exist.
Main Display	
OVER CURRENT	Communication with the USB device has been shut down because of the over-current to the USB device. Disconnect the device from the USB TO DEVICE terminal, then turn on the power of the instrument.
MIDI Receive	
MIDI receive buffer overflow.	Displayed when too much MIDI data was received at one time and failed to proceed.

NOTE

- Not all the messages are listed in the table: the messages necessary to be explained only.

Specifications

Size/Weight	Dimensions	W x D x H	946 x 405 x 137 mm (37-1/4" x 15-15/16" x 5-3/8")	
	Weight		7.3Kg (16 lbs. 1 oz.)	
Keyboard	Number of Keys		61	
	Touch Response		Yes	
Display	Type		320 x 240 dots QVGA B/W 4.3 inch display	
	Contrast		Yes	
	Score Display Function		Yes	
	Lyric Display Function		Yes	
	Language		English/Japanese	
Controller	Pitch Bend Wheel		Yes	
Panel	Language		English	
Voices	Tone Generation	Tone Generating Technology	AWM Stereo Sampling	
	Polyphony	Number of Polyphony (Max.)	64	
	Preset	Number of Voices	357 + 28 Drum/SFX Kits + 480 XG + GM2 (for GM2 Song playback) + GS (for GS Song playback)	
		Mega Voices	9	
		Live! Voices	18	
		Cool! Voices	22	
	Voice Expansion	Sweet! Voices	12	
		Voice	Yes	
		Wave	Yes (16MB Flash ROM)	
		Voice Set	Yes	
Compatibility		XG, XF, GS, GM, GM2		
Effects	Types	Reverb	35	
		Chorus	44	
		DSP	237	
		Master EQ	5	
		Harmony	26	
	Function	Dual	Yes	
		Split	Yes	
		Panel Sustain	Yes	
Accompaniment Styles	Preset	Number of Preset Styles	181	
		Fingering	Multi finger, FullKeyboard, AI Fingered	
		Style Control	Intro x 3, Ending x 3, Main x 4, Fill In x 4	
	Compatibility	SFF GE		
	Custom	User Styles	Yes	
		Style Creator	Yes	
	Other Features	Music Database	784 + External Files	
OTS (One Touch Setting)		4 for Each Style		

Song	Preset	Number of Preset Songs	9
	Custom	User Songs	Yes
		Song Edit	Yes
	Recording	Number of Songs	5
		Tracks	16
		Data Capacity	Approx. 30,000 notes (when only “melody” tracks are recorded)
		Recording Function	Quick Recording, Multi Recording, Song Editing
Compatible Data Format	Playback	SMF (Format 0 & 1), XF	
	Recording	SMF (Format 0)	
Function	Registration	Registration Memory	8 buttons (x 8 Banks) with Freeze function
	Demo	Demonstration	Yes
	Overall Controls	Metronome	Yes
		Tempo Range	5–280
		Transpose	-12 – 0 – +12
		Tuning	415.3–466.2Hz
		Octave buttons	Yes
Scale	Yes		
Expansion Pack Installation			Yes
Storage and Connectivity	Internal Memory		1,130 KB
	External Drives		Optional USB flash Memory (via USB TO DEVICE)
	Connectivity		USB TO HOST, USB TO DEVICE, DC IN 16V, PHONES/OUTPUT, SUSTAIN
Amplifiers and Speakers	Amplifiers		12W + 12W
	Speakers		12cm x 2 + 3cm x 2
Power Supply	Power Supply		Adaptor: PA-300 or an equivalent recommended by Yamaha
	Power Consumption		25 W (When using PA-300 power adaptor)
	Auto Power Off Function		Yes
Included Accessories			<ul style="list-style-type: none"> • Owner’s Manual • Data List • Music Rest • My Yamaha Product User Registration • AC Power adaptor* (PA-300 or an equivalent recommended by Yamaha) <p>* May not be included depending on your particular area. Please check with your Yamaha dealer.</p>
Optional Accessories			<ul style="list-style-type: none"> • Adaptor: PA-300 or an equivalent recommended by Yamaha • Footswitch: FC4/FC5 • Keyboard Stand: L-6/L-7 • Headphones: HPE-150/HPE-30

* Specifications and descriptions in this owner’s manual are for information purposes only. Yamaha Corp. reserves the right to change or modify products or specifications at any time without prior notice. Since specifications, equipment or options may not be the same in every locale, please check with your Yamaha dealer.

Index

+ / YES, - / NO	14	F	
▶ / ■	36	FF	36
.....	36	File Control	55–60
A ⇌ B	39	FILE MENU	55
▶▶	36	File Save (File Menu)	57–58
◀◀	36	Footswitch	10
A		Format (File Menu)	56
A-B Repeat	39	Formats	6
Accessories	5	FREEZE	51
ACMP	29	FUNCTION	15
Auto Accompaniment Range	30	Function Display	15
AUTO FILL IN	30	G	
Auto Power Off	10	GM	6
B		GS	6
Backup	53	H	
Backup Clear	53	HARMONY	19
Backup data	53	Headphones	11
Bank	49	I	
Base Note	23	Initial Setup	7
Beat	27	Initialization	53
C		Installation	61
CATEGORY	14	INTRO	31
Chord	32	K	
Chord Fingering	32	Keyboard Out	7
Chorus	19	L	
Clear (Song Track)	45	Language	12
Clear (User Song)	44	LEFT	17
Computer	63	Left Voice	17
CONTRAST	12	Left-Part	7
D		Load (File Menu)	59
DC IN	10	Local	7
Delete (File Menu)	60	LYRICS	38
Delete (User Song)	44	M	
Demo Song	37	MAIN	30
Dial	14	Main Display	13
Display	13–15	MAIN VARIATION (Style)	31
Drum Kit	18	Main Voice	16
DSP	19	Manuals	6
DUAL	17	Master Volume	11
Dual Voice	17	MDB	46
E		Measure	13
Effect	19	MEMORY	50
Ending	31	Memory clear	53
ENDING/rit.	31	Memory data	53
EXECUTE	15	Message	67
EXIT	13	Metronome	27
Expansion Pack	61	MIDI	7, 25, 63
Expansion Styles	61	Mixer	47
Expansion Voices	61	Multi Recording	41
External Clock	7	Music Database	46
External Scale Tune	25		

Music Rest	12	Style Creator	7
O		Style File	58–59
Octave	20	Style Mode	35
One Touch Setting (OTS)	34	Style Out	7
OTS LINK	34	Style Volume	7
P		SUSTAIN	10, 19
Panel Button Chart	65	SUSTAIN (Footswitch)	10
Panel Controls and Terminals	8	Sustain (Panel)	19
Panel settings	49	SYNC START	30
Part Assign	42	SYNC STOP	33
Part Select (Scale)	24	T	
PAUSE	36	Tap Start	30
PC Mode	7	TAP TEMPO	34
PHONES/OUTPUT	11	TEMPO	34
Pitch	20	Tempo (Metronome)	27
PITCH BEND	20	Tempo (Song)	36
Power Adaptor	10	Tempo (Style)	34
PRESET	35	Time Signature	27
Preset Song	36	TOUCH	26
Q		Touch Response	26
Quick Recording	40	Touch Sensitivity	26
R		Track	40
REC	40	Track Clear	45
Record	40	Track Mute	7
REGIST BANK	50	TRANSCOPE	20
REGIST/PART [MIXER]	47, 49	Troubleshooting	64
REGISTRATION MEMORY	49	Tuning	21
Repeat (A-B Repeat)	39	Tuning (Scale)	23
Reverb	19	U	
REW	36	Uninstallation	62
Right-Part	7	UPPER OCTAVE	20
S		USB	6, 33
Save	57–58	USB flash memory	54
Scale	22	USB MIDI Driver	63
Scale Tune	23	USB Song	37
SCORE	38	USB Style	33
Section	30–31	USB TO DEVICE	54
SFF GE	6	USB TO HOST	63
SMF (Standard MIDI File)	58	USER	35–36, 41
Song	35	User Song	35–36, 40
SONG category	35	V	
Song Clear	44	Voice	16
SONG CONTROL	36	VOICE category	16
Song Edit	7	VOICE CONTROL	19
SONG MODE	35	Volume	11
Song Out	7	Volume (Song)	7
Song Volume	7	Volume (Style)	7
Specifications	69	X	
Split Point	17, 30	XF	6
STANDBY/ON	11	XG	6
START/STOP	30		
Style	29		
STYLE category	29		
STYLE CONTROL	30–31		



YAMAHA

1-YEAR LIMITED WARRANTY

ON ARRANGER WORKSTATION KEYBOARDS

Thank you for selecting a Yamaha product. Yamaha products are designed and manufactured to provide a high level of defect-free performance. Yamaha Corporation of America ("Yamaha") is proud of the experience and craftsmanship that goes into each and every Yamaha product. Yamaha sells its products through a network of reputable, specially authorized dealers and is pleased to offer you, the Original Owner, the following Limited Warranty, which applies only to products that have been (1) directly purchased from Yamaha's authorized dealers in the fifty states of the USA and District of Columbia (the "Warranted Area") and (2) used exclusively in the Warranted Area. Yamaha suggests that you read the Limited Warranty thoroughly, and invites you to contact your authorized Yamaha dealer or Yamaha Customer Service if you have any questions.

Coverage: Yamaha will, at its option, repair or replace the product covered by this warranty if it becomes defective, malfunctions or otherwise fails to conform with this warranty under normal use and service during the term of this warranty, without charge for labor or materials. Repairs may be performed using new or refurbished parts that meet or exceed Yamaha specifications for new parts. If Yamaha elects to replace the product, the replacement may be a reconditioned unit. You will be responsible for any installation or removal charges and for any initial shipping charges if the product(s) must be shipped for warranty service. However, Yamaha will pay the return shipping charges to any destination within the USA if the repairs are covered by the warranty. This warranty does not cover (a) damage, deterioration or malfunction resulting from accident, negligence, misuse, abuse, improper installation or operation or failure to follow instructions according to the Owner's Manual for this product; any shipment of the product (claims must be presented to the carrier); repair or attempted repair by anyone other than Yamaha or an authorized Yamaha Service Center; (b) any unit which has been altered or on which the serial number has been defaced, modified or removed; (c) normal wear and any periodic maintenance; (d) deterioration due to perspiration, corrosive atmosphere or other external causes such as extremes in temperature or humidity; (e) damages attributable to power line surge or related electrical abnormalities, lightning damage or acts of God; or (f) RFI/EMI (Interference/noise) caused by improper grounding or the improper use of either certified or uncertified equipment, if applicable. Any evidence of alteration, erasing or forgery of proof-of-purchase documents will cause this warranty to be void. This warranty covers only the Original Owner and is not transferable.

In Order to Obtain Warranty Service: Warranty service will only be provided for defective products within the Warranted Area. Contact your local authorized Yamaha dealer who will advise you of the procedures to be followed. If this is not successful, contact Yamaha at the address, telephone number or website shown below. Yamaha may request that you send the defective product to a local authorized Yamaha Servicer or authorize return of the defective product to Yamaha for repair. If you are uncertain as to whether a dealer has been authorized by Yamaha, please contact Yamaha's Service Department at the number shown below, or check Yamaha's website at www.Yamaha.com. Product(s) shipped for service should be packed securely and must be accompanied by a detailed explanation of the problem(s) requiring service, together with the original or a machine reproduction of the bill of sale or other dated, proof-of-purchase document describing the product, as evidence of warranty coverage. Should any product submitted for warranty service be found ineligible therefore, an estimate of repair cost will be furnished and the repair will be accomplished only if requested by you and upon receipt of payment or acceptable arrangement for payment.

Limitation of Implied Warranties and Exclusion of Damages: ANY IMPLIED WARRANTIES, INCLUDING WARRANTIES OF MERCHANTABILITY AND FITNESS FOR A PARTICULAR PURPOSE SHALL BE LIMITED IN DURATION TO THE APPLICABLE PERIOD OF TIME SET FORTH ABOVE. YAMAHA SHALL NOT BE RESPONSIBLE FOR INCIDENTAL OR CONSEQUENTIAL DAMAGES OR FOR DAMAGES BASED UPON INCONVENIENCE, LOSS OF USE, DAMAGE TO ANY OTHER EQUIPMENT OR OTHER ITEMS AT THE SITE OF USE OR INTERRUPTION OF PERFORMANCES OR ANY CONSEQUENCES. YAMAHA'S LIABILITY FOR ANY DEFECTIVE PRODUCT IS LIMITED TO REPAIR OR REPLACEMENT OF THE PRODUCT, AT YAMAHA'S OPTION. SOME STATES DO NOT ALLOW LIMITATIONS ON HOW LONG AN IMPLIED WARRANTY LASTS OR THE EXCLUSION OR LIMITATION OF INCIDENTAL OR CONSEQUENTIAL DAMAGES, SO THE ABOVE LIMITATION OR EXCLUSION MAY NOT APPLY TO YOU. This Warranty gives you specific legal rights, and you may also have other rights which vary from state to state. This is the only express warranty applicable to the product specified herein; Yamaha neither assumes nor authorizes anyone to assume for it any other express warranty.

If you have any questions about service received or if you need assistance in locating an authorized Yamaha Servicer, please contact:



YAMAHA

CUSTOMER SERVICE

Yamaha Corporation of America

6600 Orangethorpe Avenue, Buena Park, California 90620-1373

Telephone: 800-854-1569

www.yamaha.com

Do not return any product to the above address without a written Return Authorization issued by Yamaha.

For details of products, please contact your nearest Yamaha representative or the authorized distributor listed below.

Pour plus de détails sur les produits, veuillez-vous adresser à Yamaha ou au distributeur le plus proche de vous figurant dans la liste suivante.

Para obter detalhes de produtos, entre em contato com o representante mais próximo da Yamaha ou com o distribuidor autorizado relacionado a seguir.

Para detalles sobre productos, contacte su tienda Yamaha más cercana o el distribuidor autorizado que se lista debajo.

Die Einzelheiten zu Produkten sind bei Ihrer unten aufgeführten Niederlassung und bei Yamaha Vertragshändlern in den jeweiligen Bestimmungsländern erhältlich.

Подробные сведения об инструменте можно получить у местного представителя корпорации Yamaha или уполномоченного дистрибьютора, указанного в следующем списке.

NORTH AMERICA

CANADA

Yamaha Canada Music Ltd.
135 Milner Avenue, Scarborough, Ontario,
M1S 3R1, Canada
Tel: 416-298-1311

U.S.A.

Yamaha Corporation of America
6600 Orangethorpe Ave., Buena Park, Calif. 90620,
U.S.A.
Tel: 714-522-9011

CENTRAL & SOUTH AMERICA

MEXICO

Yamaha de México S.A. de C.V.
Calz. Javier Rojo Gómez #1149,
Col. Guadalupe del Moral
C.P. 09300, México, D.F., México
Tel: 55-5804-0600

BRAZIL

Yamaha Musical do Brasil Ltda.
Rua Joaquim Floriano, 913 - 4º andar, Itaim Bibi,
CEP 04534-013 Sao Paulo, SP. BRAZIL
Tel: 011-3704-1377

ARGENTINA

Yamaha Music Latin America, S.A.
Sucursal de Argentina
Olga Cossetini 1553, Piso 4 Norte
Madero Este-C1107CEK
Buenos Aires, Argentina
Tel: 011-4119-7000

PANAMA AND OTHER LATIN AMERICAN COUNTRIES/ CARIBBEAN COUNTRIES

Yamaha Music Latin America, S.A.
Torre Banco General, Piso 7, Urbanización Marbella,
Calle 47 y Aquilino de la Guardia,
Ciudad de Panamá, Panamá
Tel: +507-269-5311

EUROPE

THE UNITED KINGDOM/IRELAND

Yamaha Music U.K. Ltd.
Sherbourne Drive, Tilbrook, Milton Keynes,
MK7 8BL, England
Tel: 01908-366700

GERMANY

Yamaha Music Europe GmbH
Siemensstraße 22-34, 25462 Rellingen, Germany
Tel: 04101-3030

SWITZERLAND/LIECHTENSTEIN

Yamaha Music Europe GmbH
Branch Switzerland in Zürich
Seefeldstrasse 94, 8008 Zürich, Switzerland
Tel: 01-383 3990

AUSTRIA

Yamaha Music Europe GmbH Branch Austria
Schleiergasse 20, A-1100 Wien, Austria
Tel: 01-60203900

CZECH REPUBLIC/SLOVAKIA/ HUNGARY/SLOVENIA

Yamaha Music Europe GmbH Branch Austria
Schleiergasse 20, A-1100 Wien, Austria
Tel: 01-60203905

POLAND/LITHUANIA/LATVIA/ESTONIA

Yamaha Music Europe GmbH
Branch Sp.z o.o. Oddział w Polsce
ul. 17 Stycznia 56, PL-02-146 Warszawa, Poland
Tel: 022-500-2925

THE NETHERLANDS/ BELGIUM/LUXEMBOURG

Yamaha Music Europe Branch Benelux
Clarissenhof 5-b, 4133 AB Vianen, The Netherlands
Tel: 0347-358 040

FRANCE

Yamaha Musique France
BP 70-77312 Marne-la-Vallée Cedex 2, France
Tel: 01-64-61-4000

ITALY

Yamaha Musica Italia S.P.A.
Viale Italia 88, 20020 Lainate (Milano), Italy
Tel: 02-935-771

SPAIN/PORTUGAL

Yamaha Música Ibérica, S.A.
Ctra. de la Coruna km. 17, 200, 28230
Las Rozas (Madrid), Spain
Tel: 91-639-8888

GREECE

Philippos Nakas S.A. The Music House
147 Skiathou Street, 112-55 Athens, Greece
Tel: 01-228 2160

SWEDEN

Yamaha Scandinavia AB
J. A. Wettergrens Gata 1, Box 30053
S-400 43 Göteborg, Sweden
Tel: 031 89 34 00

DENMARK

YS Copenhagen Liaison Office
Generatorvej 6A, DK-2730 Herlev, Denmark
Tel: 44 92 49 00

FINLAND

F-Musiikki Oy
Kluuvikatu 6, P.O. Box 260,
SF-00101 Helsinki, Finland
Tel: 09 618511

NORWAY

Norsk filial av Yamaha Scandinavia AB
Grini Næringspark 1, N-1345 Østerås, Norway
Tel: 67 16 77 70

ICELAND

Skifan HF
Skeifan 17 P.O. Box 8120, IS-128 Reykjavik, Iceland
Tel: 525 5000

RUSSIA

Yamaha Music (Russia)
Room 37, bld. 7, Kievskaya street, Moscow,
121059, Russia
Tel: 495 626 5005

OTHER EUROPEAN COUNTRIES

Yamaha Music Europe GmbH
Siemensstraße 22-34, 25462 Rellingen, Germany
Tel: +49-4101-3030

AFRICA

Yamaha Corporation,
Asia-Pacific Sales & Marketing Group
Nakazawa-cho 10-1, Naka-ku, Hamamatsu,
Japan 430-8650
Tel: +81-53-460-2317

MIDDLE EAST

TURKEY/CYPRUS

Yamaha Music Europe GmbH
Siemensstraße 22-34, 25462 Rellingen, Germany
Tel: 04101-3030

OTHER COUNTRIES

Yamaha Music Gulf FZE
LOB 16-513, P.O.Box 17328, Jubel Ali,
Dubai, United Arab Emirates
Tel: +971-4-881-5868

ASIA

THE PEOPLE'S REPUBLIC OF CHINA

Yamaha Music & Electronics (China) Co., Ltd.
2F, Yunhedasha, 1818 Xinzha-lu, Jingan-qu,
Shanghai, China
Tel: 021-6247-2211

HONG KONG

Tom Lee Music Co., Ltd.
11/F, Silvercord Tower 1, 30 Canton Road,
Tsimshatsui, Kowloon, Hong Kong
Tel: 2737-7688

INDIA

Yamaha Music India Pvt. Ltd.
5F Ambience Corporate Tower Ambience Mall Complex
Ambience Island, NH-8, Gurgaon-122001, Haryana, India
Tel: 0124-466-5551

INDONESIA

PT. Yamaha Musik Indonesia (Distributor)
PT. Nusantik
Gedung Yamaha Music Center, Jalan Jend. Gatot
Subroto Kav. 4, Jakarta 12930, Indonesia
Tel: 021-520-2577

KOREA

Yamaha Music Korea Ltd.
8F, 9F, Dongsung Bldg. 158-9 Samsung-Dong,
Kangnam-Gu, Seoul, Korea
Tel: 02-3467-3300

MALAYSIA

Yamaha Music (Malaysia) Sdn., Bhd.
Lot 8, Jalan Perbandaran, 47301 Kelana Jaya,
Petaling Jaya, Selangor, Malaysia
Tel: 03-78030900

PHILIPPINES

Yupangco Music Corporation
339 Gil J. Puyat Avenue, P.O. Box 885 MCPO,
Makati, Metro Manila, Philippines
Tel: 819-7551

SINGAPORE

Yamaha Music (Asia) Pte., Ltd.
#03-11 A-Z Building
140 Paya Lebar Road, Singapore 409015
Tel: 6747-4374

TAIWAN

Yamaha KHS Music Co., Ltd.
3F, #6, Sec.2, Nan Jing E. Rd. Taipei.
Taiwan 104, R.O.C.
Tel: 02-2511-8688

THAILAND

Siam Music Yamaha Co., Ltd.
4, 6, 15 and 16th floor, Siam Motors Building,
891/1 Rama 1 Road, Wangmai,
Pathumwan, Bangkok 10330, Thailand
Tel: 02-215-2622

OTHER ASIAN COUNTRIES

Yamaha Corporation,
Asia-Pacific Sales & Marketing Group
Nakazawa-cho 10-1, Naka-ku, Hamamatsu,
Japan 430-8650
Tel: +81-53-460-2317

OCEANIA

AUSTRALIA

Yamaha Music Australia Pty. Ltd.
Level 1, 99 Queensbridge Street, Southbank,
Victoria 3006, Australia
Tel: 3-9693-5111

NEW ZEALAND

Music Works LTD
P.O. BOX 6246 Wellesley, Auckland 4680,
New Zealand
Tel: 9-634-0099

COUNTRIES AND TRUST TERRITORIES IN PACIFIC OCEAN

Yamaha Corporation,
Asia-Pacific Sales & Marketing Group
Nakazawa-cho 10-1, Naka-ku, Hamamatsu,
Japan 430-8650
Tel: +81-53-460-2317



Yamaha Global Home
<http://www.yamaha.com/>

Yamaha Manual Library
<http://www.yamaha.co.jp/manual/>

U.R.G., Digital Musical Instruments Division
© 2011 Yamaha Corporation

***POTY* *-01A0
Printed in China

WW73170