



NS-P620

(NS-P620: NS-10MMT + NS-C10MM + YST-SW105)

HOME CINEMA 5.1CH SPEAKER PACKAGE



OWNER'S MANUAL

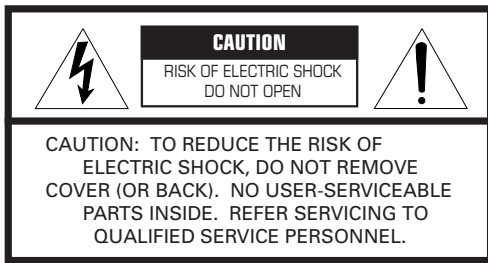

IMPORTANT
Please record the serial number of this system in the space below.

Model:

Serial No.:

The serial number is located on the rear of the main unit.
Retain this Owner's Manual in a safe place for future reference.

• Explanation of Graphical Symbols

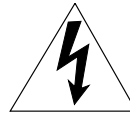

The lightning flash with arrowhead symbol, within an equilateral triangle, is intended to alert you to the presence of uninsulated "dangerous voltage" within the product's enclosure that may be of sufficient magnitude to constitute a risk of electric shock to persons.



The exclamation point within an equilateral triangle is intended to alert you to the presence of important operating and maintenance (servicing) instructions in the literature accompanying the appliance.

WARNING
TO REDUCE THE RISK OF FIRE OR ELECTRIC SHOCK, DO NOT EXPOSE THIS APPLIANCE TO RAIN OR MOISTURE.

IMPORTANT SAFETY INSTRUCTIONS

- 1 Read Instructions – All the safety and operating instructions should be read before the product is operated.
- 2 Retain Instructions – The safety and operating instructions should be retained for future reference.
- 3 Heed Warnings – All warnings on the product and in the operating instructions should be adhered to.
- 4 Follow Instructions – All operating and use instructions should be followed.
- 5 Cleaning – Unplug this product from the wall outlet before cleaning. Do not use liquid cleaners or aerosol cleaners. Use a damp cloth for cleaning.
- 6 Attachments – Do not use attachments not recommended by the product manufacturer as they may cause hazards.
- 7 Water and Moisture – Do not use this product near water – for example, near a bath tub, wash bowl, kitchen sink, or laundry tub; in a wet basement; or near a swimming pool; and the like.
- 8 Accessories – Do not place this product on an unstable cart, stand, tripod, bracket, or table. The product may fall, causing serious injury to a child or adult, and serious damage to the product. Use only with a cart, stand, tripod, bracket, or table recommended by the manufacturer, or sold with the product. Any mounting of the product should follow the manufacturer's instructions, and should use a mounting accessory recommended by the manufacturer.
- 9 A product and cart combination should be moved with care. Quick stops, excessive force, and uneven surfaces may cause the product and cart combination to overturn.
- 10 Ventilation – Slots and openings in the cabinet are provided for ventilation and to ensure reliable operation of the product and to protect it from overheating, and these openings must not be blocked or covered. The openings should never be blocked by placing the product on a bed, sofa, rug, or other similar surface. This product should not be placed in a built-in installation such as a bookcase or rack unless proper ventilation is provided or the manufacturer's instructions have been adhered to.
- 11 Power Sources – This product should be operated only from the type of power source indicated on the marking label. If you are not sure of the type of power supply to your home, consult your product dealer or local power company. For products intended to operate from battery power, or other sources, refer to the operating instructions.
- 12 Grounding or Polarization – This product may be equipped with a polarized alternating current line plug (a plug having one blade wider than the other). This plug will fit into the power outlet only one way. This is a safety feature. If you are unable to insert the plug fully into the outlet, try reversing the plug. If the plug should still fail to fit, contact your electrician to replace your obsolete outlet. Do not defeat the safety purpose of the polarized plug.
- 13 Power-Cord Protection – Power-supply cords should be routed so that they are not likely to be walked on or pinched by items placed upon or against them, paying particular attention to cords at plugs, convenience receptacles, and the point where they exit from the product.
- 14 Lightning – For added protection for this product during a lightning storm, or when it is left unattended and unused for long periods of time, unplug it from the wall outlet and disconnect the antenna or cable system. This will prevent damage to the product due to lightning and power-line surges.
- 15 Power Lines – An outside antenna system should not be located in the vicinity of overhead power lines or other electric light or power circuits, or where it can fall into such power lines or circuits. When installing an outside antenna system, extreme care should be taken to keep from touching such power lines or circuits as contact with them might be fatal.
- 16 Overloading – Do not overload wall outlets, extension cords, or integral convenience receptacles as this can result in a risk of fire or electric shock.
- 17 Object and Liquid Entry – Never push objects of any kind into this product through openings as they may touch dangerous voltage points or short-out parts that could result in a fire or electric shock. Never spill liquid of any kind on the product.



- 18** Servicing – Do not attempt to service this product yourself as opening or removing covers may expose you to dangerous voltage or other hazards. Refer all servicing to qualified service personnel.
- 19** Damage Requiring Service – Unplug this product from the wall outlet and refer servicing to qualified service personnel under the following conditions:
- When the power-supply cord or plug is damaged,
 - If liquid has been spilled, or objects have fallen into the product,
 - If the product has been exposed to rain or water,
 - If the product does not operate normally by following the operating instructions. Adjust only those controls that are covered by the operating instructions as an improper adjustment of other controls may result in damage and will often require extensive work by a qualified technician to restore the product to its normal operation,
 - If the product has been dropped or damaged in any way, and
 - When the product exhibits a distinct change in performance - this indicates a need for service.
- 20** Replacement Parts – When replacement parts are required, be sure the service technician has used replacement parts specified by the manufacturer or have the same characteristics as the original part. Unauthorized substitutions may result in fire, electric shock, or other hazards.
- 21** Safety Check – Upon completion of any service or repairs to this product, ask the service technician to perform safety checks to determine that the product is in proper operating condition.
- 22** Wall or Ceiling Mounting – The unit should be mounted to a wall or ceiling only as recommended by the manufacturer.
- 23** Heat – The product should be situated away from heat sources such as radiators, heat registers, stoves, or other products (including amplifiers) that produce heat.

FCC INFORMATION (for US customers only)

1. IMPORTANT NOTICE : DO NOT MODIFY THIS UNIT!

This product, when installed as indicated in the instructions contained in this manual, meets FCC requirements. Modifications not expressly approved by Yamaha may void your authority, granted by the FCC, to use the product.

2. IMPORTANT : When connecting this product to accessories and/or another product use only high quality shielded cables. Cable/s supplied with this product MUST be used. Follow all installation instructions. Failure to follow instructions could void your FCC authorization to use this product in the USA.

3. NOTE : This product has been tested and found to comply with the requirements listed in FCC Regulations, Part 15 for Class "B" digital devices. Compliance with these requirements provides a reasonable level of assurance that your use of this product in a residential environment will not result in harmful interference with other electronic devices.

This equipment generates/uses radio frequencies and, if not installed and used according to the instructions found in the users manual, may cause interference harmful to the operation of other electronic devices.

Compliance with FCC regulations does not guarantee that interference will not occur in all installations. If this product is found to be the source of interference, which can be determined by turning the unit "OFF" and "ON", please try to eliminate the problem by using one of the following measures:

Relocate either this product or the device that is being affected by the interference.

Utilize power outlets that are on different branch (circuit breaker or fuse) circuits or install AC line filter/s.

In the case of radio or TV interference, relocate/reorient the antenna. If the antenna lead-in is 300 ohm ribbon lead, change the lead-in to coaxial type cable.

If these corrective measures do not produce satisfactory results, please contact the local retailer authorized to distribute this type of product. If you can not locate the appropriate retailer, please contact Yamaha Electronics Corp., U.S.A. 6660 Orangethorpe Ave, Buena Park, CA 90620.

The above statements apply ONLY to those products distributed by Yamaha Corporation of America or its subsidiaries.

We Want You Listening For A Lifetime





YAMAHA and the Electronic Industries Association's Consumer Electronics Group want you to get the most out of your equipment by playing it at a safe level. One that lets the sound come through loud and clear without annoying blaring or distortion – and, most importantly, without affecting your sensitive hearing.

Since hearing damage from loud sounds is often undetectable until it is too late, YAMAHA and the Electronic Industries Association's Consumer Electronics Group recommend you to avoid prolonged exposure from excessive volume levels.

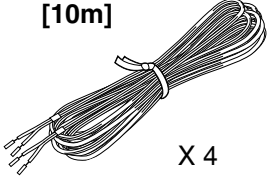

UNPACKING

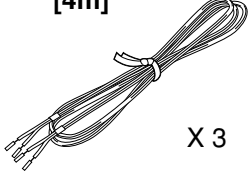
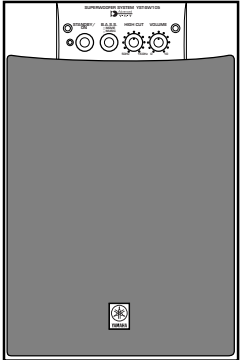
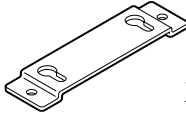
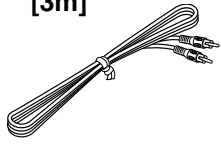
After unpacking, check that the following items are included.

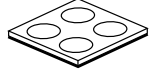
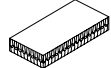
<p>Main and rear speakers</p>  <p>X 4</p> <p><NS-10MMT></p>	<p>Speaker cables</p> <p>[10m]</p>  <p>X 4</p>
<p>Center speaker</p>  <p><NS-C10MM></p>	<p>Speaker cables</p> <p>[4m]</p>  <p>X 3</p>
<p>Subwoofer</p>  <p><YST-SW105></p>	<p>Mounting brackets</p>  <p>X 4</p>
<p>Subwoofer cable</p> <p>[3m]</p> 	<p>Screws</p>  <p>X 8</p>
	<p>Pads (for NS-10MMT)</p>  <p>X 2</p>
	<p>Nonskid pads (for YST-SW105)</p> 
	<p>Fasteners</p>  <p>X 4</p>

CAUTION: Read this before operating your unit.

- To assure the finest performance, please read this manual carefully. Keep it in a safe place for future reference.
- Install the speakers in a cool, dry, clean place – away from windows, heat sources, sources of excessive vibration, dust, moisture and cold. Avoid sources of humming (transformers, motors). To prevent fire or electric shock, do not expose the speakers to rain or water.
- To prevent the enclosure from warping or discoloring, do not place the speakers where they will be exposed to direct sunlight or excessive humidity.
- Do not place the following objects on top of the speakers:
 - Other components, as they might cause damage and/or discoloration on the surface of the speakers.
 - Burning objects (i.e. candles), as they might cause fire, damage to the speakers and/or personal injury.
 - Containers with liquid in them, as they might cause electric shock to the user and/or damage to the speakers.
- Do not place the speakers where they are liable to be knocked over or struck by falling objects. Stable placement will also ensure better sound performance.
- Placing the speakers on the same shelf or rack as the turntable can result in feedback.
- Secure placement or installation is the owner's responsibility. YAMAHA shall not be liable for any accident caused by improper placement or installation of speakers.
- Any time you note distortion, reduce the volume control on your amplifier to a lower setting. Never allow your amplifier to be driven into "clipping". Otherwise the speakers may be damaged.
- When using an amplifier with a rated output power higher than the nominal input power of the speakers, care should be taken never to exceed the speakers' maximum input.
- Do not attempt to clean the speakers with chemical solvents as this might damage the finish. Use a clean, dry cloth.
- Do not attempt to modify or fix the speakers. Contact qualified YAMAHA service personnel when any service is needed. The cabinet should never be opened for any reasons.
- Be sure to read the "TROUBLESHOOTING" section regarding common operating errors before concluding that the speakers are faulty.
- Do not cover the rear panel of this unit with a newspaper, a tablecloth, a curtain, etc. in order not to obstruct heat radiation. If the temperature inside this unit rises, it may cause fire, damage to this unit and/or personal injury.
- Do not plug in this unit to a wall outlet until all connections are completed.
- The voltage to be used must be the same as that specified on the rear panel. Using this unit with a higher voltage than specified is dangerous and may cause fire, damage to this unit, and/or personal injury. YAMAHA will not be held responsible for any damage resulting from use of this unit with a voltage other than specified.
- To prevent lightning damage, disconnect the AC power plug when there is an electric storm.
- Super-bass frequencies reproduced by this unit may cause a turntable to generate a howling sound. In such a case, move this unit away from the turntable.
- This unit may be damaged if certain sounds are continuously outputted at high volume level. For example, if 20 Hz–50 Hz sine waves from a test disc, bass sounds from electronic instruments, etc. are continuously outputted, or when the stylus of a turntable touches the surface of a disc, reduce the volume level to prevent this unit from being damaged.
- If you hear distorted noise (i.e. unnatural, intermittent "rapping" or "hammering" sounds) coming from this unit, reduce the volume level. Extremely loud playing of a movie soundtrack's low frequency, bass-heavy sounds or similarly loud popular music passages can damage this speaker system.
- Vibration generated by super-bass frequencies may distort images on a TV. In such a case, move this unit away from the TV set.
- When disconnecting the power cord from the wall outlet, grasp the plug; do not pull the cord.
- When not planning to use this unit for a long period (i.e. vacation, etc.), disconnect the AC power plug from the wall outlet.
- **VOLTAGE SELECTOR (China and General models only)**
The voltage selector switch on the rear panel of this unit must be set for your local main voltage BEFORE plugging this unit into the AC main supply.
Voltages are 110/120/220/240 V AC, 50/60 Hz.

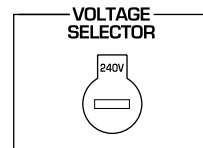

For YST-SW105 only

- Do not operate this unit upside down. It may overheat, possibly causing damage.
- Do not use force on switches, controls or connection wires. When moving this unit, first disconnect the power plug and the wires connected to other equipments. Never pull the wires themselves.
- Since this unit has a built-in power amplifier, heat will radiate from the rear panel. Place the unit apart from the walls, allowing enough spaces above, behind and on both sides of the unit to prevent fire or damage. Furthermore, do not position with the rear panel facing down on the floor or other surfaces.
<For U.K. and Europe models only>
Be sure to allow spaces of at least 20 cm above, behind and on both sides of the unit.
- When using a humidifier, be sure to avoid condensation inside this unit by allowing enough spaces around this unit or avoiding excess humidification. Condensation might cause a fire, damage to this unit, and/or electric shock.

Standby mode

When this unit is turned off by pressing the STANDBY/ON button on the front panel, it consumes a small amount of power. This state is called the standby mode. This unit's power supply is completely cut off from the AC line only when the POWER switch on the rear panel is set in the OFF position or the AC power cord is disconnected.

These speakers feature a magnetically shielded design, but there is still a chance that placing them too close to a TV set might impair picture color. Should this happen, move the speakers away from the TV set.

For U.K. customers

If the socket outlets in the home are not suitable for the plug supplied with this appliance, it should be cut off and an appropriate 3 pin plug fitted. For details, refer to the instructions described below.

Note: The plug severed from the mains lead must be destroyed, as a plug with bared flexible cord is hazardous if engaged in a live socket outlet.

For Canadian Customers

To prevent electric shock, match wide blade of plug to wide slot and fully insert.

This Class B digital apparatus complies with Canadian ICES-003.

SPECIAL INSTRUCTIONS FOR U.K. MODEL

IMPORTANT:

THE WIRES IN MAINS LEAD ARE COLOURED IN ACCORDANCE WITH THE FOLLOWING CODE:

Blue: NEUTRAL

Brown: LIVE

As the colours of the wires in the mains lead of this apparatus may not correspond with the coloured markings identifying the terminals in your plug, proceed as follows: The wire which is coloured BLUE must be connected to the terminal which is marked with the letter N or coloured BLACK. The wire which is coloured BROWN must be connected to the terminal which is marked with the letter L or coloured RED. Making sure that neither core is connected to the earth terminal of the three pin plug.

COMPONENTS OF THE PACKAGE

The speaker package "NS-P620" is designed for use in a multi-channel audio system such as a home theater system. The package includes four NS-10MMT speaker systems, one NS-C10MM speaker system and one YST-SW105 subwoofer system.

<NS-10MMT>

2-way bass-reflex speaker system used for the main and rear speakers

<NS-C10MM>

2-way bass-reflex speaker system used for the center speaker

<YST-SW105>

Active Servo Processing Subwoofer System with a built-in power amplifier

- This subwoofer system employs Advanced YAMAHA Active Servo Technology which YAMAHA has developed for reproducing higher quality super-bass sound. (Refer to page 14 for details on Advanced YAMAHA Active Servo Technology.) This super-bass sound adds a more realistic, theater-in-the-home effect to your stereo system.
- This subwoofer can be easily added to your existing audio system by connecting to either the speaker terminals or the line output (pin jack) terminals of the amplifier.
- The HIGH CUT control enables you to adjust the tone balance between the subwoofer and the main speakers.
- The Automatic power-switching function saves you the trouble of pressing the STANDBY/ON button to turn the power on or turn it to the STANDBY mode.

CONTENTS

IMPORTANT SAFETY INSTRUCTIONS	II	USING THE SUBWOOFER (YST-SW105) ...	10
UNPACKING	IV	Controls and their functions	10
CAUTION	1	Automatic power-switching function	11
COMPONENTS OF THE PACKAGE	2	Adjusting the subwoofer before use	12
SETTING UP THE SPEAKERS	3	Frequency characteristics	13
Placing the subwoofer	3	ADVANCED YAMAHA ACTIVE SERVO	
Mounting the rear speakers	4	TECHNOLOGY (for YST-SW105)	14
Placing the center speaker	5	TROUBLESHOOTING	15
CONNECTIONS	6	SPECIFICATIONS	Back cover
An example of basic connections	6		
How to connect speaker cables	8		
Connecting the subwoofer to speaker output terminals of the amplifier	9		

SETTING UP THE SPEAKERS

Before making connections, place all speakers in their respective positions. The positioning of the speakers is important because it controls the whole sound quality of this system.

Place the speakers depending on your listening position by following the instructions below.

Speaker configuration

This speaker package employs a 6 speaker configuration: 2 main speakers, 2 rear speakers, a center speaker and a subwoofer.

The main speakers are used for main source sound. The rear speakers are used for surround sounds, and the center speaker is for center sounds (dialog etc.). The subwoofer is for reinforcing low frequencies on your audio system.

Note

In this speaker package, the same speakers (NS-10MMT) are used for the main and rear speakers.

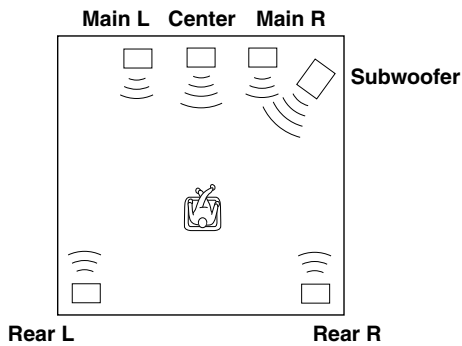

Placing speakers

Main speakers: On both sides of and at approximately the same height as the TV set.

Rear speakers: Behind your listening position, facing slightly inward. About 1.8 m (approx. 6 feet) from the floor.

Center speaker: Precisely between the main speakers.

Subwoofer: The position of the subwoofer is not so critical because low bass tones are not highly directional. Refer to "Placing the subwoofer" below for a recommended positioning of the subwoofer.

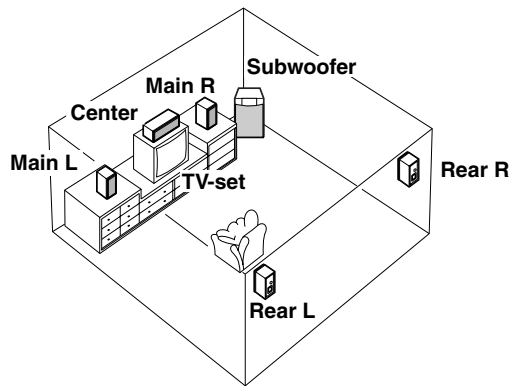

■ Placing the subwoofer

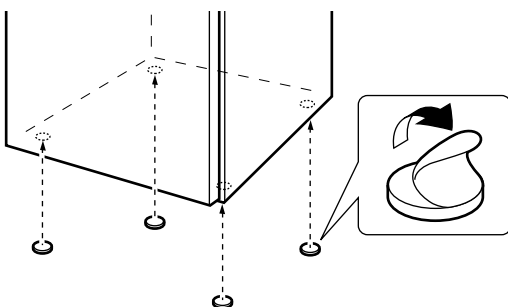
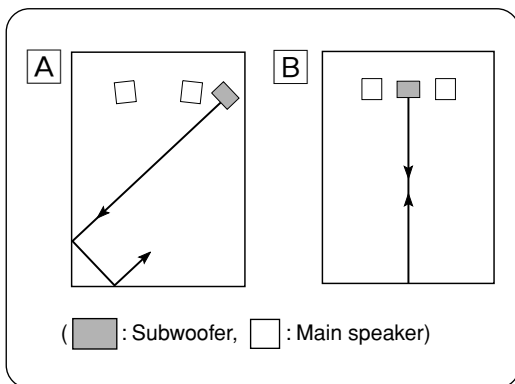

It is recommended to place the subwoofer on the outside of either the right or the left main speaker. (See fig. [A].) The placement shown in fig. [B] is also possible, however, if the subwoofer system is placed directly facing the wall, the bass effect may die because the sound from it and the sound reflected by the wall may cancel out each other. To prevent this from happening, face the subwoofer system at an angle as shown in fig. [A].

Note

There may be a case that you cannot obtain enough super-bass sounds from the subwoofer when listening in the center of the room. This is because "standing waves" have been developed between two parallel walls and they cancel the bass sounds.

In such a case, face the subwoofer obliquely to the wall. It also may be necessary to break up the parallel surfaces by placing bookshelves etc. along the walls.

Use the nonskid pads

Put the provided nonskid pads at the four corners on the bottom of the subwoofer to prevent the subwoofer from moving by vibrations etc.

■ Mounting the rear speakers

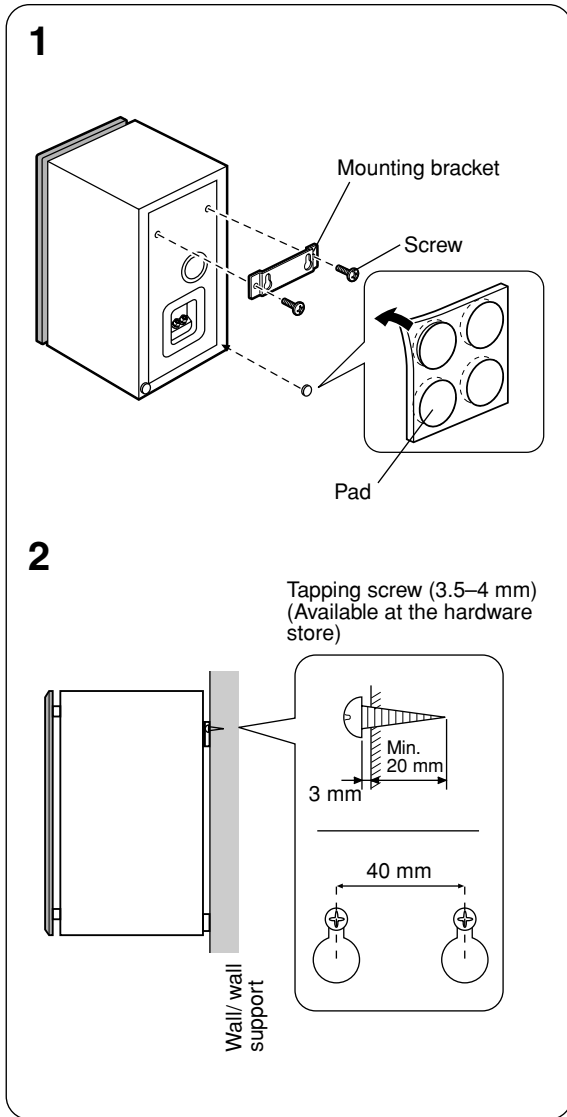

Mount the rear speakers on a shelf, rack or directly on the floor, or hang them on the wall.

To mount the rear speakers on a wall by using the provided mounting brackets

- 1** Attach the bracket to the rear of the speaker by using the provided screws. Remove the provided pads from the backing sheet and put them at the lower corners of the speakers.
- 2** Fasten screws into a firm wall or wall support as shown in the figure, and hang the holes of the mounting bracket on the protruding screws.
 - * Make sure that the screws are securely caught by the narrow parts of the holes.

WARNING

- Each speaker weighs 1.5 kg (3 lbs. 5 oz.). Do not mount them on thin plywood or a wall with soft surface material. If mounted, the screws may come out of the flimsy surface and the speakers may fall. This damages the speakers or causes personal injury.
- Do not install the speakers to a wall with nails, adhesives, or any other unstable hardware. Long-term use and vibrations may cause them to fall.
- To avoid accidents resulting from tripping over loose speaker cables, fix them to the wall.
- Select a proper position on the wall to mount the speaker so that no one will injure his/her head or face.

You can also use the screw holes on the bottom of the speaker for installing the speakers on commercially available speaker stands (if you do not use the provided mounting brackets.)

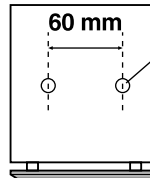

A screw with a diameter of 4 mm can be used.
(Hole depth : 10 mm)

■ Placing the center speaker

Place the speaker on TV whose top is flat or on the floor under the TV or inside the TV rack so that it is stabilized. When placing the speaker on top of the TV, to prevent the speaker from falling down, put the provided fasteners at four points on the bottom of the speaker and the top of the TV.

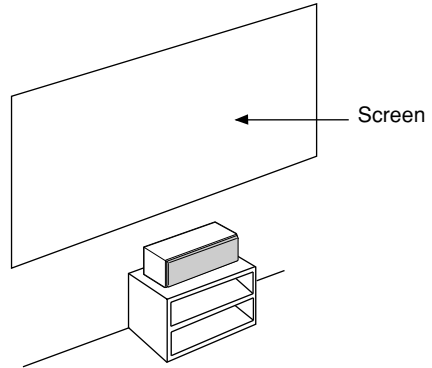
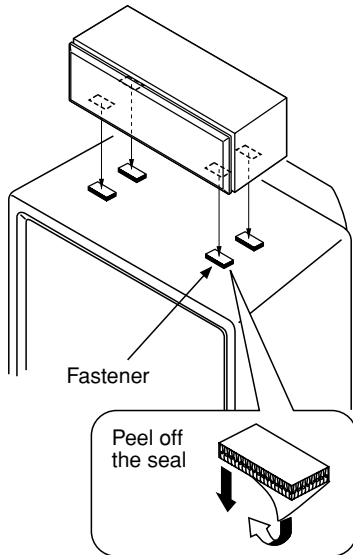

Notes

- Do not place the speaker on top of the TV whose area is smaller than the bottom area of the speaker. If placed, the speaker may drop out causing an injury to you.
- Do not place the speaker on top of the TV with an inclination.
- Do not touch the adhesive surface after peeling off the seal as this will weaken its adhesive strength.
- Thoroughly wipe clean the surface where the fastener is to be applied. Note that adhesive strength is weakened if the surface is dirty, oily or wet and that this may cause the center speaker to drop.

Removing the front cover

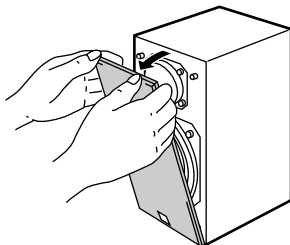

The front cover is fastened to the enclosure at four points and can be removed if desired. To remove the cover, hold on to both sides and slowly pull straight away from the speaker. To reattach, line up the four holes on the inner surface of the cover with the four corresponding pegs on the speaker and push gently.

Note

When the cover is removed, be sure not to touch the speaker units with your hands or to exert excessive force with tools.

CONNECTIONS

Caution: Plug in the subwoofer and other audio/video components after all connections are completed.

■ An example of basic connections

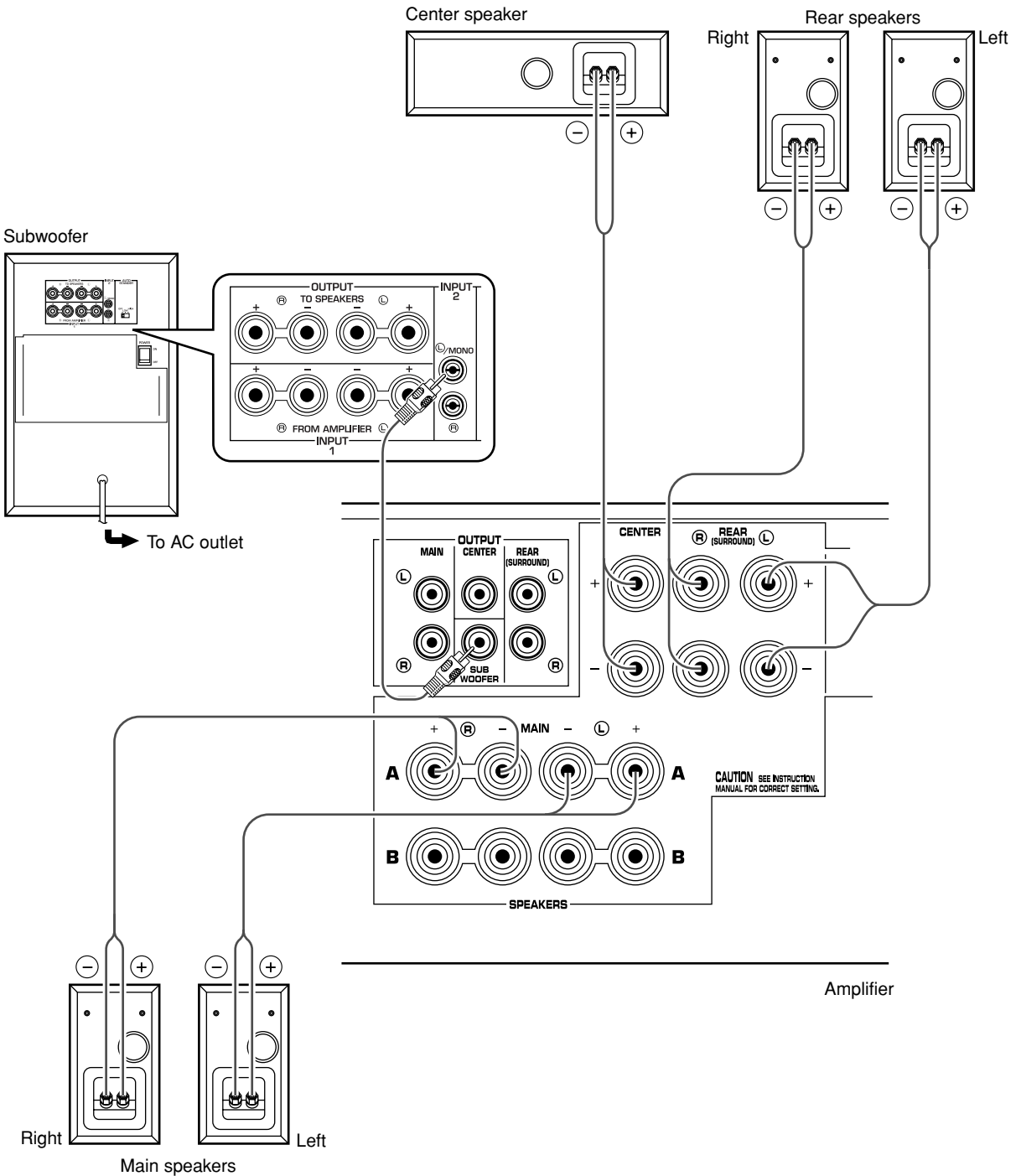

- Connect the main, center and rear speakers to the speaker output terminals of your amplifier with the provided speaker cables.
 - * Connect each speaker making sure not to reverse the polarity (+, -). If the speaker is connected with reversed polarity, the sound will be unnatural and lack bass.
 - * For the main and rear speakers only, connect one speaker to the left (marked L) terminals of your amplifier, and another speaker to the right (marked R) terminals.
- Basically, connect the subwoofer to the line output (pin jack) terminal(s) of the amplifier. If your amplifier does not have any line output terminal, connect the subwoofer to the speaker output terminals of the amplifier. (Refer to page 9 for details.)
 - * To connect with a YAMAHA DSP amplifier (or AV receiver), connect the SUBWOOFER (or LOW PASS etc.) terminal on the rear of the DSP amplifier (or AV receiver) to the **L** INPUT2 terminal of the subwoofer.
 - * To connect the subwoofer to the SPLIT SUBWOOFER terminals on the rear of the DSP amplifier, connect them to both the left **L** and right **R** INPUT2 terminals of the subwoofer.

Note

When connecting to a monaural line output terminal of the amplifier, connect to the **L** INPUT2 terminal.

■ How to connect speaker cables

Main/center/rear speakers

Red: positive (+)
Black: negative (-)

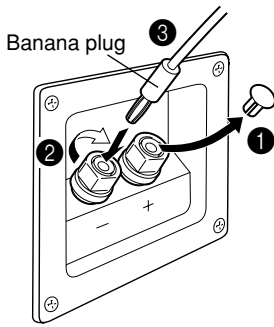
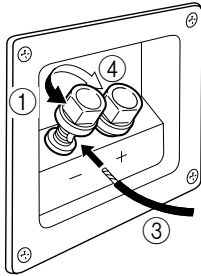

Subwoofer (INPUT1/OUTPUT terminals)

Red: positive (+)
Black: negative (-)

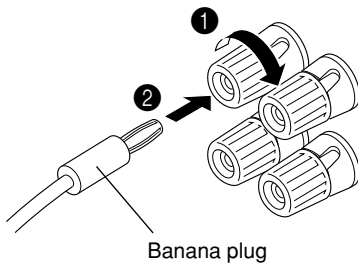
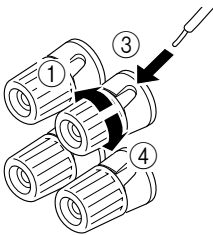

For connections, keep the speaker cables as short as possible. Do not bundle or roll up the excess part of the cables. If the connections are faulty, no sound will be heard from the speakers. Make sure that the + and - polarity markings of the speaker cables are observed and set correctly. If these cables are reversed, the sound will be unnatural and lack bass.

How to Connect:

- ① Loosen the knob.
- ② Remove the insulation coating at the extremity of each speaker cable by twisting the coating off.

Good No Good



- ③ Insert the bare wire.
- ④ Tighten the knob and secure the cables.
Test the firmness of the connection by pulling lightly on the cables at the terminal.

Note

Do not let the bare speaker wires touch each other as this could damage the speaker or the amplifier, or both of them.

When using a banana plug

<U.S.A., Canada, Australia, China and General models only>

(Main/center/rear speakers)

- ① Remove the cover by pulling it toward you.
- ② Tighten the terminal knob.
- ③ Simply insert the banana plug into the terminal.

(Subwoofer)

- ① Tighten the terminal knob.
- ② Simply insert the banana plug into the terminal.

■ Connecting the subwoofer to speaker output terminals of the amplifier

If your amplifier has only one set of main speaker output terminals

Connect the speaker output terminals of the amplifier to the INPUT1 terminals of the subwoofer, and connect the OUTPUT terminals of the subwoofer to the main speakers.

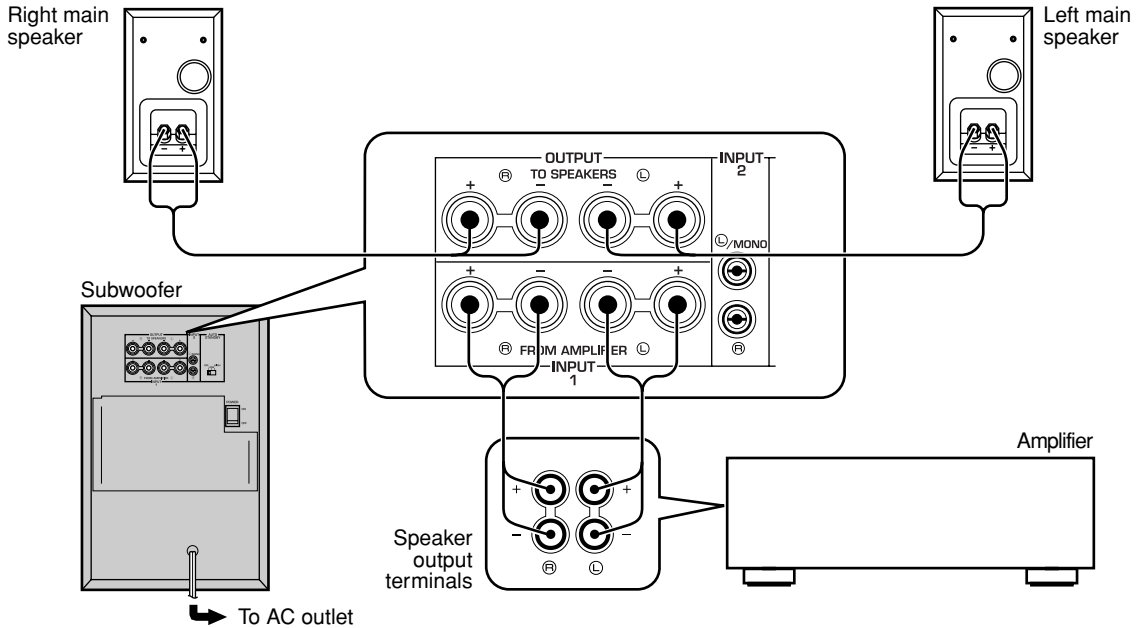

If your amplifier has two sets of speaker output terminals

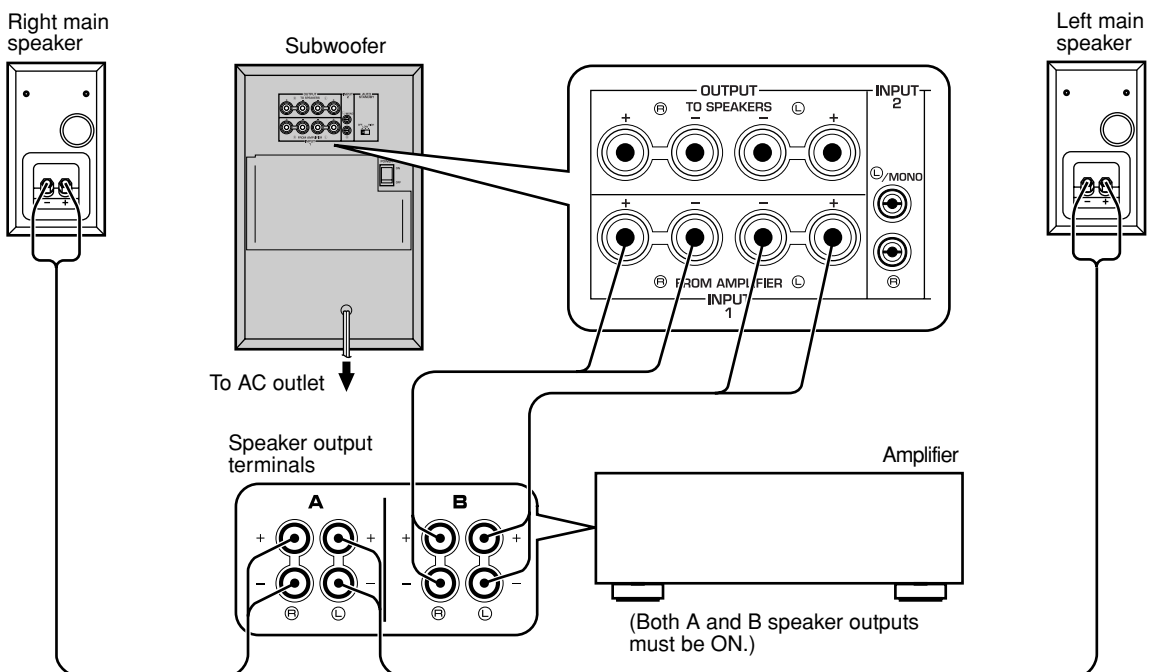

USING THE SUBWOOFER (YST-SW105)

■ Controls and their functions

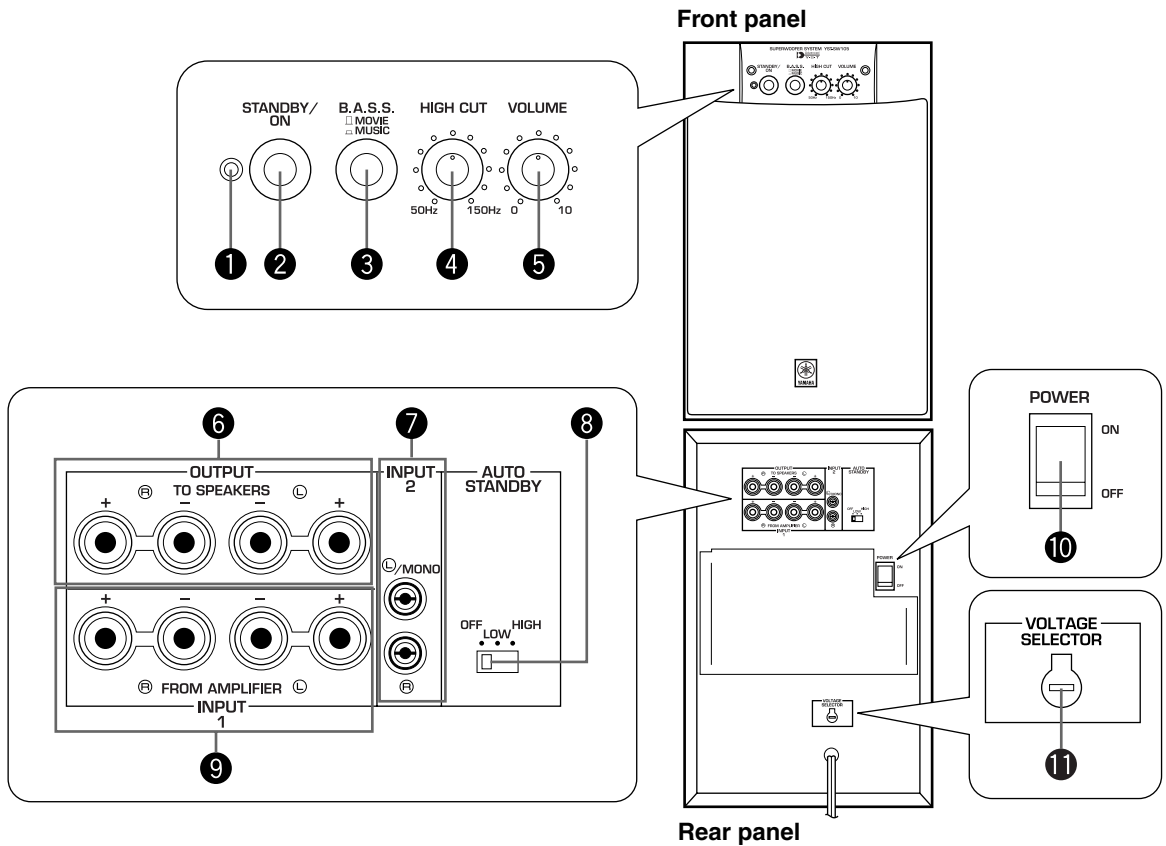

- 1** Power indicator
Lights up in green while the subwoofer is turned on.
- 2** **STANDBY/ON** button
Press this button to turn on the power. (The power indicator lights up in green.)
Press again to set the subwoofer in the standby mode. (The power indicator does not light.)
* This button can be used only when the **POWER (10)** switch is set in the ON position.

Standby mode
The subwoofer is still using a small amount of power in this mode.

- 3** **B.A.S.S.** (Bass Action Selector System) button
When this button is pressed in to the **MUSIC** position, the bass sound in audio software is well reproduced. By pressing the button again so that it pops out at the **MOVIE** position, the bass sound in video software is well reproduced.



- 4** **HIGH CUT** control
Adjusts the high frequency cut off point. Frequencies higher than the frequency selected by this control are all cut off (and no output).
* One graduation of this control represents 10 Hz.

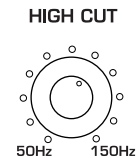

- 5** **VOLUME** control
Adjusts the volume level. Turn the control clockwise to increase the volume, and counterclockwise to decrease the volume.
- 6** **OUTPUT (TO SPEAKERS)** terminals
Can be used for connecting to the main speakers. Signals from the **INPUT1** terminals (**9**) are sent to these terminals.
(Refer to "**CONNECTIONS**" for details.)

- 7 INPUT2** terminals
Used to input line level signals from the amplifier.
(Refer to “**CONNECTIONS**” for details.)
- 8 AUTO STANDBY (HIGH/LOW/OFF)** switch
This switch is originally set to the OFF position. By setting this switch to the HIGH or LOW position, the subwoofer’s automatic power-switching function operates as described below. If you do not need this function, leave this switch in the OFF position.
* Make sure to change the setting of this switch only when the subwoofer is in the standby mode. (The power indicator does not light.)
- 9 INPUT1 (FROM AMPLIFIER)** terminals
Used to connect the subwoofer with the speaker terminals of the amplifier.
(Refer to “**CONNECTIONS**” for details.)

- 10 POWER** switch
Normally, set this switch to the ON position to use the subwoofer. In this state, you can turn on the subwoofer or turn the subwoofer into the standby mode by pressing the **STANDBY/ON** (2) button. Set this switch to the OFF position to completely cut off the subwoofer’s power supply from the AC line.

- 11 VOLTAGE SELECTOR** switch
(China and General models only)
If the preset setting of the switch is incorrect, set the switch to the proper voltage (110V, 120V, 220V or 240V) of your area.
Consult your dealer if you are unsure of the correct setting.

WARNING

Be sure to unplug the subwoofer before setting the VOLTAGE SELECTOR switch correctly.

■ Automatic power-switching function

If the source being played is stopped and the input signal is cut off for 7 to 8 minutes, the subwoofer automatically switches to the standby mode. (When the subwoofer switches to the standby mode by the automatic power-switching function, the power indicator lights up in red.)

When you play a source again, the power of the subwoofer turns on automatically by sensing audio signals input to the subwoofer.

This function operates by sensing a certain level of low frequency input signal. Usually set the **AUTO STANDBY** switch to the LOW position. However, if the power is not switched to ON or STANDBY smoothly, set the switch to the HIGH position. In the HIGH position, the power will turn on even with a low level of input signal. But please be aware that the subwoofer may not switch to the standby mode when there is an extremely low input signal.

- * The power might turn on unexpectedly by sensing noise from other appliances. If that occurs, set the **AUTO STANDBY** switch to the OFF position and use the STANDBY/ON button to switch the power between ON and STANDBY manually.
- * This function detects the low-frequency components below 200 Hz of the input signals (i.e., the explosion in the action movie, the sound of the bass guitar or the bass drum, etc.).
- * The minutes required to switch the subwoofer to the standby mode might change by sensing noise from other appliances.

This function is available only when the power of the subwoofer is on (by pressing the STANDBY/ON button).

■ Adjusting the subwoofer before use

Before using the subwoofer, adjust the subwoofer to obtain the optimum volume and tone balance between the subwoofer and the main speakers by following the procedures described below.

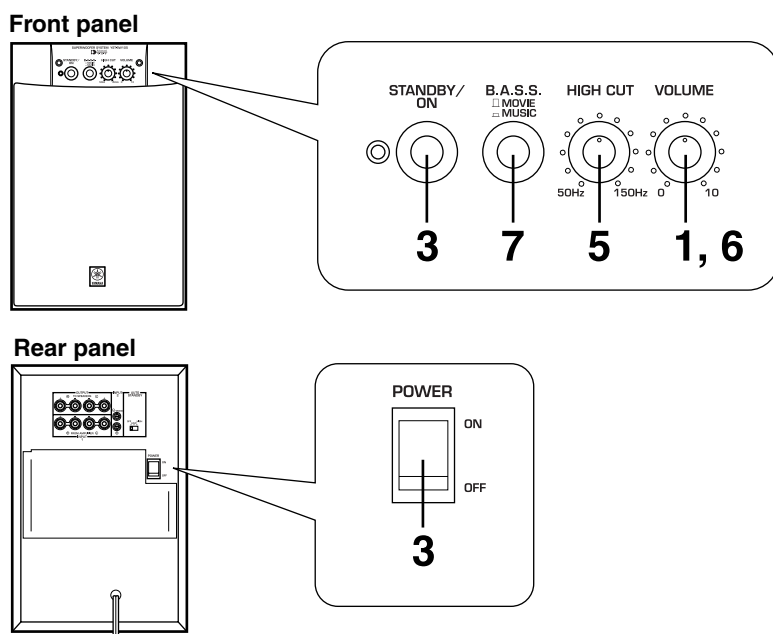

- 1 Set the **VOLUME** control to minimum (0).
- 2 Turn on the power of all the other components.
- 3 Make sure that the **POWER** switch is set to the ON position, then press the **STANDBY/ON** button to turn on the subwoofer.
* The Power indicator lights up in green.
- 4 Play a source containing low-frequency components and adjust the amplifier's volume control to the desired listening level.
- 5 Adjust the **HIGH CUT** control to the position where the desired response can be obtained.

This system is designed so that the optimum tone balance between the subwoofer and the main speakers (NS-10MMT) is obtained when this control is set at 110 Hz. However, the tone balance may change depending on the room size, the distance from the subwoofer to the main speakers, etc. So, if you prefer, turn the **HIGH CUT** control and set it to a position where a better tone balance is obtained.

- 6 Increase the volume gradually to adjust the volume balance between the subwoofer and the main speakers.
- 7 Select "MOVIE" or "MUSIC" according to the played source.

MOVIE: When a movie type source is played, the low-frequency effects are enhanced to allow the listener enjoy more powerful sound. (The sound will be thicker and deeper.)

MUSIC: When an ordinary music source is played, the excessive low-frequency components are cut off to make the sound clearer. (The sound will be lighter and reproduces the melody line more clearly.)

- Once the volume balance between the subwoofer and the main speakers is adjusted, you can adjust the volume of your whole sound system by using the amplifier's volume control. However, if you change the main speakers NS-10MMT to others, you must make this adjustment again.
- For adjusting the **VOLUME** control and the **HIGH CUT** control, refer to "Frequency characteristics" on the next page.

■ Frequency characteristics

Adjustment of the **VOLUME** control and the **HIGH CUT** control should be changed depending on the room size, the distance from the subwoofer to the main speakers, sources, etc.

Following figures show the optimum adjustment of each control and the frequency characteristics when this subwoofer is combined with NS-10MMT.

Frequency characteristics of this subwoofer (YST-SW105)

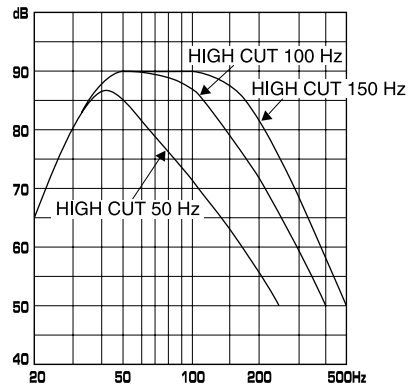

• When combined with NS-10MMT

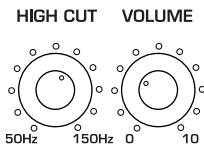

* One graduation of this control represents 10 Hz.

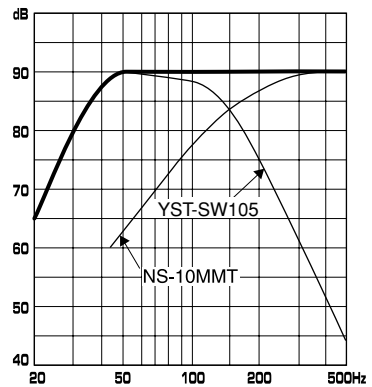

ADVANCED YAMAHA ACTIVE SERVO TECHNOLOGY (for YST-SW105)

The theory of Yamaha Active Servo Technology has been based upon two major factors, the Helmholtz resonator and negative-impedance drive. Active Servo Processing speakers reproduce the bass frequencies through an “air woofer”, which is a port or opening in the speaker’s cabinet. This opening is used instead of, and performs the functions of, a woofer in a conventionally designed speaker system. Thus, signals of low amplitude within the cabinet can, according to the Helmholtz resonance theory, be outputted from this opening as waves of great amplitude if the size of the opening and the volume of the cabinet are in the correct proportion to satisfy a certain ratio.

In order to accomplish this, moreover, the amplitudes within the cabinet must be both precise and of sufficient power because these amplitudes must overcome the “load” presented by the air that exists within the cabinet.

Thus it is this problem that is resolved through the employment of a new design in which the amplifier supplies special signals. If the electrical resistance of the voice coil could be reduced to zero, the movement of the speaker unit would become linear with respect to signal voltage. To accomplish this, a special negative-impedance output-drive amplifier for subtracting output impedance of the amplifier is used.

By employing negative-impedance drive circuits, the amplifier is able to generate precise, low-amplitude, low-frequency waves with superior damping characteristics. These waves are then radiated from the cabinet opening as high-amplitude signals. The system can, therefore, by employing the negative-impedance output drive amplifier and a speaker cabinet with the Helmholtz resonator, reproduce an extremely wide range of frequencies with amazing sound quality and less distortion.

The features described above, then, are combined to be the fundamental structure of the conventional Yamaha Active Servo Technology.

Our new Active Servo Technology — Advanced Yamaha Active Servo Technology — adopted Advanced Negative Impedance Converter (ANIC) circuits, which allows the conventional negative impedance converter to dynamically vary in order to select an optimum value for speaker impedance variation. With this new ANIC circuits, Advanced Yamaha Active Servo Technology can provide more stable performance and improved sound pressure compared with the conventional Yamaha Active Servo Technology, resulting in more natural and dynamic bass reproduction.

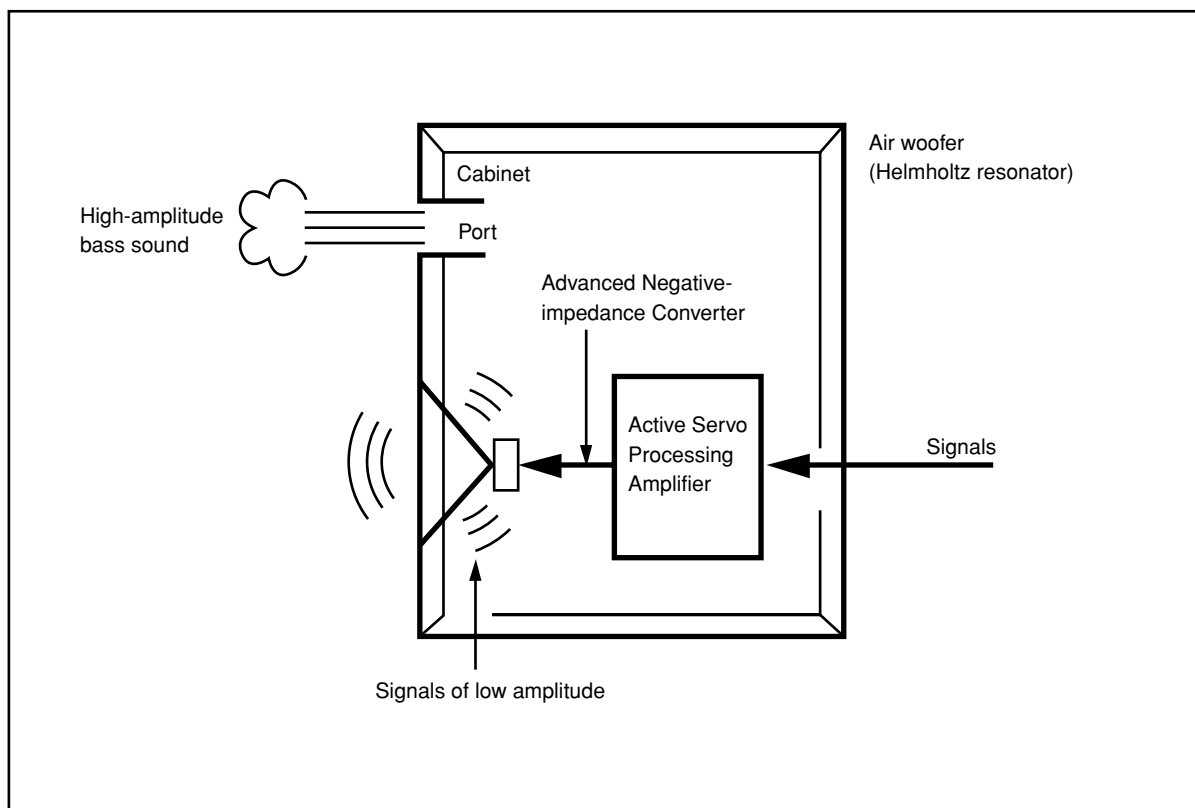

TROUBLESHOOTING

Refer to the chart below when this unit does not function properly. If the problem you are experiencing is not listed below or if the instructions given below do not help, disconnect the power cord and contact your authorized YAMAHA dealer or service center.

Problem	Cause	What to Do
No sound.	Speaker cables are not connected securely.	Connect them securely.
Sound level is too low.	Speaker cables are not connected correctly.	Connect them correctly, that is L (left) to L, R (right) to R, “+” to “+” and “-” to “-”.

For YST-SW105

Problem	Cause	What to Do
Power is not supplied even though the STANDBY/ON button is set to the ON position.	The power plug is not securely connected.	Connect it securely.
	The POWER switch is set to the OFF position.	Set the POWER switch to the ON position.
No sound.	The VOLUME control is set to 0.	Turn the VOLUME control to the right.
	Speaker cables are not connected securely.	Connect them securely.
Sound level is too low.	Speaker cables are not connected correctly.	Connect them correctly, that is L (left) to L, R (right) to R, “+” to “+” and “-” to “-”.
	A source sound with few bass frequencies is played.	Play a source sound with bass frequencies.
	It is influenced by standing waves.	Reposition the subwoofer or break up the parallel surface by placing bookshelves etc. along the walls.
The subwoofer does not turn on automatically.	The POWER switch is set to the OFF position.	Set the POWER switch to the ON position.
	The STANDBY/ON button is set to the OFF position.	Set the STANDBY/ON button to the ON position.
	The AUTO STANDBY switch is set to the OFF position.	Set the AUTO STANDBY switch to the “HIGH” or “LOW” position.
	The level of input signal is too low.	Set the AUTO STANDBY switch to the “HIGH” position.
The subwoofer does not turn into the standby mode automatically.	There is an influence of noise generated from external appliances etc.	Move the subwoofer farther away from such appliances and/or reposition the connected speaker cables. Otherwise, set the AUTO STANDBY switch to the “OFF” position.
	The AUTO STANDBY switch is set to the OFF position.	Set the AUTO STANDBY switch to the “HIGH” or “LOW” position.
The subwoofer turns into the standby mode unexpectedly.	The level of input signal is too low.	Set the AUTO STANDBY switch to the “HIGH” position.
The subwoofer turns on unexpectedly.	There is an influence of noise generated from external appliances etc.	Move the subwoofer farther away from such appliances and/or reposition the connected speaker cables. Otherwise, set the AUTO STANDBY switch to the “OFF” position.

SPECIFICATIONS

■ NS-10MMT

Type 2-way bass-reflex speaker system
Magnetic shielding type

Driver 9 cm (3-9/16") cone woofer
2.5 cm (1") balanced dome tweeter

Impedance 6Ω

Frequency Response 75 Hz to 33 kHz

Nominal Input Power 40W

Maximum Input Power 100W

Sensitivity 88 dB/2.83V/m

Crossover Frequency 7 kHz

Dimensions (W x H x D) 107 x 191 x 141 mm
(4-3/16" x 7-1/2" x 5-9/16")

Weight 1.5 kg (3 lbs. 5 oz.) x 4

■ NS-C10MM

Type 2-way bass-reflex speaker system
Magnetic shielding type

Driver 9 cm (3-9/16") cone woofer x 2
2.5 cm (1") balanced dome tweeter

Impedance 6Ω

Frequency Response 100 Hz to 33 kHz

Nominal Input Power 50W

Maximum Input Power 125W

Sensitivity 91 dB/2.83V/m

Crossover Frequency 7 kHz

Dimensions (W x H x D) 312 x 101 x 141 mm
(12-5/16" x 4" x 5-9/16")

Weight 2.3 kg (5 lbs. 1 oz.)

■ YST-SW105

Type Advanced Yamaha Active Servo Technology

Driver 20 cm (8") cone woofer
Magnetic shielding type

Amplifier Output 100W/5Ω

Frequency Response 30 Hz to 200 Hz

Power Supply
U.S.A. and Canada models AC 120V, 60 Hz
U.K. and Europe models AC 230V, 50 Hz
Australia model AC 240V, 50 Hz
China and General models
..... AC 110/120/220/240V, 50/60 Hz

Power Consumption 80W
(In the standby mode: 0.8W)

Dimensions (W x H x D) 235 x 365 x 312 mm
(9-5/16" x 14-7/20" x 12-5/16")

Weight 9.5 kg (20 lbs. 15 oz.)

■ Accessories

Subwoofer cable x 1
Speaker cable (10 m) x 4
Speaker cable (4 m) x 3
Mounting bracket x 4
Screw x 8
Pad (for NS-10MMT) x 8
Fastener x 4
Nonskid pad (for YST-SW105) x 4

* Specifications are subject to change without notice due to product improvements.

