

YAMAHA

YAMAHA MUSIC DISK RECORDER

MDR-4

OWNER'S MANUAL
BEDIENUNGSANLEITUNG
MODE D'EMPLOI
MANUAL DE INSTRUCCIONES

ENGLISH

DEUTSCH

FRANÇAIS

ESPAÑOL

Precautions

Handling and Operation

● Never attempt to disassemble, modify or otherwise tamper with the MDR-4 or any of its parts. Doing so could cause serious damage to the MDR-4. ● Avoid applying excessive force to the buttons and controls of the MDR-4, or subjecting the unit to excessive vibration or sudden shock. ● Avoid using the MDR-4 in environments where it will be exposed to direct sunlight, temperature extremes, high humidity or moisture, and excessive dust or sand. ● If water or any liquid accidentally seeps into the MDR-4, or if it produces any abnormal odor or smoke, immediately turn off the power to the unit, unplug the power cord, and contact the Yamaha dealer from which you purchased the unit (or your nearest authorized Yamaha service center).

Cleaning

● Clean the outer case by wiping it only with a soft, dry cloth. If necessary, use a soft, clean cloth slightly moistened with a diluted, mild detergent making sure to wipe the case off again with a dry cloth. ● Never use thinner, benzene, chemically harsh solvents or cleansers, or chemically treated cloths.

Vorsichtsmaßnahmen

Handhabung und Bedienung

● Versuchen Sie niemals, den MDR-4 oder eines seiner Teile zu zerlegen, zu modifizieren oder auf sonstige Weise zu verändern. Hierdurch können schwerwiegende Schäden am MDR-4 auftreten. ● Vermeiden Sie es, die Tasten und Bedienelemente des MDR-4 mit Gewalt zu betätigen, und achten Sie darauf, daß das Gerät nicht übermäßigen Vibrationen oder starken Stößen ausgesetzt wird. ● Vermeiden Sie es, den MDR-4 in einer Umgebung zu verwenden, wo er direkter Sonneneinstrahlung, extremen Temperaturen, hoher Luftfeuchtigkeit oder Niederschlag, und übermäßigem Staub oder Sand ausgesetzt ist. ● Wenn versehentlich Wasser oder eine andere Flüssigkeit in den MDR-4 eindringt, oder wenn er einen ungewöhnlichen Geruch oder Rauch erzeugt, schalten Sie das Gerät sofort ab, ziehen das Netzkabel heraus und setzen sich mit Ihrem Yamaha-Händler in Verbindung, wo Sie das Gerät erworben haben (oder einem autorisierten Yamaha-Händler oder -Kundendienstzentrum in Ihrer Nähe).

Reinigung

● Reinigen Sie das Gehäuse ausschließlich mit einem weichen, trockenen Tuch. Falls erforderlich, feuchten Sie ein weiches, sauberes Tuch nur ganz leicht mit Wasser an, das etwas Spülmittel enthält, und reiben Sie dann anschließend das Gehäuse mit einem trockenen Tuch nach. ● Verwenden Sie niemals Farbverdünner, Benzin, chemisch aggressive Lösungs- oder Reinigungsmittel oder chemisch imprägnierte Reinigungstücher.

Précautions à observer

Manipulation et fonctionnement

● N'essayez jamais de démonter, modifier ou bricoler le MDR-4 et l'un de ses organes. Vous risqueriez de l'endommager gravement. ● Manipulez les boutons et les commandes du MDR-4 en douceur. Évitez d'exposer l'appareil à de fortes vibrations ou à des chocs. ● Évitez d'utiliser le MDR-4 dans un environnement où il risque d'être exposé directement au soleil, à une source de chaleur excessive, à la pluie ou à l'humidité, à la poussière, au sable, etc. ● Si vous avez renversé de l'eau ou un autre liquide dans le MDR-4, ou bien s'il dégage une odeur anormale ou de la fumée, mettez-le immédiatement hors tension, débranchez le cordon d'alimentation et contactez l'agent Yamaha chez qui vous avez acheté l'appareil (ou le centre de service agréé par Yamaha le plus proche).

Nettoyage

● Nettoyez le coffret extérieur simplement en l'essuyant avec un chiffon doux et sec. Si nécessaire, éliminez les taches en frottant avec un chiffon propre légèrement imbibé d'un détergent doux et dilué. Essuyez ensuite avec un chiffon sec. ● N'employez jamais des produits ou détergents chimiques agressifs comme des diluants ou du benzène, ni des chiffons imprégnés de produits chimiques.

Precauciones

Cuidados y funcionamiento

● Nunca intente desensamblar, modificar o manipular indebidamente el MDR-4 ni ninguno de sus componentes. Si lo hace podría causar daños serios al MDR-4. ● No aplique fuerza excesiva a los botones ni a los controles del MDR-4, ni someta a la unidad a vibraciones excesivas ni a golpes súbitos. ● Trate de no utilizar el MDR-4 en ambientes en los que quede expuesto a la luz directa del sol, alta humedad o donde haya polvo excesivo o arena. ● Si le entra agua o líquido accidentalmente al MDR-4, o si produce olor anormal o humo, apague inmediatamente la unidad, desenchufe la alimentación y póngase en contacto con el concesionario Yamaha donde adquirió la unidad (o con el centro de servicio autorizado Yamaha más próximo).

Limpieza

● Limpie la parte exterior con un paño suave seco. Si es necesario humedezca el paño con detergente suave diluido, secando después la caja con un paño seco. ● Nunca utilice diluyentes, bencina, solventes o enjuagadores que tengan mucha química ni paños tratados químicamente.

Wichtiger Hinweis für die Benutzung in der Bundesrepublik Deutschland.

Bescheinigung des Importeurs

Hiermit wird bescheinigt daß der/die/das

Musikinstrument Typ: MDR-4

(Gerät, Typ, Bezeichnung)

in Übereinstimmung mit den Bestimmungen der

VERFÜGUNG 1046/84

(Amtsblattverfügung)

funk-entstört ist.

Der Deutschen Bundespost wurde das Inverkehrbringen dieses Gerätes angezeigt und die Berechtigung zur Überprüfung der Serie auf Einhaltung der Bestimmungen eingeräumt.

Yamaha Europa GmbH

Name des Importeurs

Dette apparat overholder det gældende EF-Direktiv vedrørende radiostøj.

Cet appareil est conforme aux prescriptions de la directive communautaire 87/308/CEE.

Diese Geräte entsprechen der EG-Richtlinie 82/499/EWG und/oder 87/308/EWG.

This product complies with the radio frequency interference requirements of the Council Directive 82/499/EEC and/or 87/308/EEC.

Questo apparecchio è conforme al D.M.13 aprile 1989 (Direttiva CEE/87/308) sulla soppressione dei radiodisturbi.

Este producto está de acuerdo con los requisitos sobre interferencias de radio frecuencia fijados por el Consejo 87/308/CEE.

YAMAHA CORPORATION

CANADA

THIS DIGITAL APPARATUS DOES NOT EXCEED THE "CLASS B" LIMITS FOR RADIO NOISE EMISSIONS FROM DIGITAL APPARATUS SET OUT IN THE RADIO INTERFERENCE REGULATION OF THE CANADIAN DEPARTMENT OF COMMUNICATIONS.

LE PRESENT APPAREIL NUMERIQUE N'EMET PAS DE BRUITS RADIOELECTRIQUES DEPASSANT LES LIMITES APPLICABLES AUX APPAREILS NUMERIQUES DE LA "CLASSE B" PRESCRITES DANS LE REGLEMENT SUR LE BROUILLAGE RADIOELECTRIQUE EDICTE PAR LE MINISTRE DES COMMUNICATIONS DU CANADA.

- This applies only to products distributed by Yamaha Europa GmbH.
- Dies bezieht sich nur auf die von der Yamaha Europa GmbH Vertriebenen Produkte.
- Ceci ne s'applique qu'aux produits distribués par Yamaha Europa GmbH.
- Esto se aplica solamente a productos distribuidos por Yamaha Europa GmbH.

- This applies only to products distributed by Yamaha Canada Music Ltd.
- Ceci ne s'applique qu'aux produits distribués par Yamaha Canada Music Ltd.

FCC INFORMATION

IMPORTANT NOTICE: DO NOT MODIFY THIS UNIT!

This product, when installed as indicated in the instructions contained in this manual, meets FCC requirements. Modifications not expressly approved by Yamaha may void your authority, granted by the FCC, to use the product.

IMPORTANT:

When connecting this product to accessories and/or another product use only high quality shielded cables. Cable/s supplied with this product MUST be used. Follow all installation instructions. Failure to follow instructions could void your FCC authorization to use this product in the USA.

NOTE:

This product has been tested and found to comply with the requirements listed in FCC Regulations, Part 15 for Class "B" digital devices. Compliance with these requirements provides a reasonable level of assurance that your use of this product in a residential environment will not result in harmful interference with other electronic devices. This equipment generates/uses radio frequencies and, if not installed and used according to the instructions found in the user's manual, may cause interference

harmful to the operation of other electronic devices. Compliance with FCC regulations does not guarantee that interference will not occur in all installations. If this product is found to be the source of interference, which can be determined by turning the unit "OFF" and "ON", please try to eliminate the problem by using one of the following measures:

- Relocate either this product or the device that is being affected by the interference.
- Utilize power outlets that are on different branch (circuit breaker or fuse) circuits or install AC line filter/s.
- In the case of radio or TV interference, relocate/reorient the antenna. If the antenna lead-in is 300 ohm ribbon lead, change the lead-in to co-axial type cable.

If these corrective measures do not produce satisfactory results, please contact the local retailer authorized to distribute this type of product. If you can not locate the appropriate retailer, please contact Yamaha Corporation of America, Electronic Service Division, 6600 Orangethorpe Ave, Buena Park CA, 90620

- This applies only to products distributed by Yamaha Corporation of America.

SPECIAL MESSAGE SECTION

This product utilizes batteries or an external power supply (adaptor). DO NOT connect this product to any power supply or adaptor other than one described in the manual, on the name plate, or specifically recommended by Yamaha.

This product should be used only with the components supplied or; a cart, rack, or stand that is recommended by Yamaha. If a cart, etc., is used, please observe all safety markings and instructions that accompany the accessory product.

SPECIFICATIONS SUBJECT TO CHANGE:

The information contained in this manual is believed to be correct at the time of printing. However, Yamaha reserves the right to change or modify any of the specifications without notice or obligation to update existing units.

This product, either alone or in combination with an amplifier and headphones or speaker/s, may be capable of producing sound levels that could cause permanent hearing loss. DO NOT operate for long periods of time at a high volume level or at a level that is uncomfortable. If you experience any hearing loss or ringing in the ears, you should consult an audiologist. **IMPORTANT:** The louder the sound, the shorter the time period before damage occurs.

NOTICE:

Service charges incurred due to lack of knowledge relating to how a function or effect works (when the unit is operating as designed) are not covered by the manufacturer's warranty, and are therefore the owners responsibility. Please study this manual carefully and consult your dealer before requesting service.

ENVIRONMENTAL ISSUES:

Yamaha strives to produce products that are both user safe and environmentally friendly. We sincerely believe that our products and the production methods used to produce them, meet these goals. In keeping with both the letter and the spirit of the law, we want you to be aware of the following:

Battery Notice:

This product MAY contain a small non-rechargeable battery which (if applicable) is soldered in place. The average life span of this type of

battery is approximately five years. When replacement becomes necessary, contact a qualified service representative to perform the replacement.

This product may also use "household" type batteries. Some of these may be rechargeable. Make sure that the battery being charged is a rechargeable type and that the charger is intended for the battery being charged.

When installing batteries, do not mix old batteries with new, or with batteries of a different type. Batteries MUST be installed correctly. Mismatches or incorrect installation may result in overheating and battery case rupture.

Warning:

Do not attempt to disassemble, or incinerate any battery. Keep all batteries away from children. Dispose of used batteries promptly and as regulated by the laws in your area. Note: Check with any retailer of household type batteries in your area for battery disposal information.

Disposal Notice:

Should this product become damaged beyond repair, or for some reason its useful life is considered to be at an end, please observe all local, state, and federal regulations that relate to the disposal of products that contain lead, batteries, plastics, etc. If your dealer is unable to assist you, please contact Yamaha directly.

NAME PLATE LOCATION:

The name plate is located on the rear of the product. The model number, serial number, power requirements, etc., are located on this plate. You should record the model number, serial number, and the date of purchase in the spaces provided below and retain this manual as a permanent record of your purchase.

Model _____

Serial No. _____

Purchase Date _____

PLEASE KEEP THIS MANUAL

Panel Controls and Terminals

The following section shows the panel controls and terminals. Some buttons in addition to their primary function, have a secondary, shifted-state function. To call up a shifted-state function, simultaneously hold down the SHIFT button and press the appropriate button.

Front and Top Panels

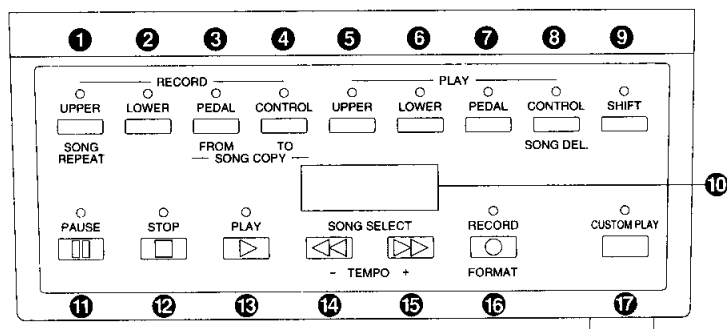

RECORD Section

- ① UPPER/SONG REPEAT button
- ② LOWER button
- ③ PEDAL/SONG COPY FROM/K.PERC. button
- ④ CONTROL/SONG COPY TO button

PLAY Section

- ⑤ UPPER button
- ⑥ LOWER button
- ⑦ PEDAL/K.PERC. button
- ⑧ CONTROL/SONG DEL. button
- ⑨ SHIFT button
- ⑩ LED display
- ⑪ PAUSE/REM.MEM. button
- ⑫ STOP button
- ⑬ PLAY button
- ⑭ SONG SELECT/◀◀/TEMPO - button
- ⑮ SONG SELECT/▶▶/TEMPO + button
- ⑯ RECORD/FORMAT button
- ⑰ CUSTOM PLAY button

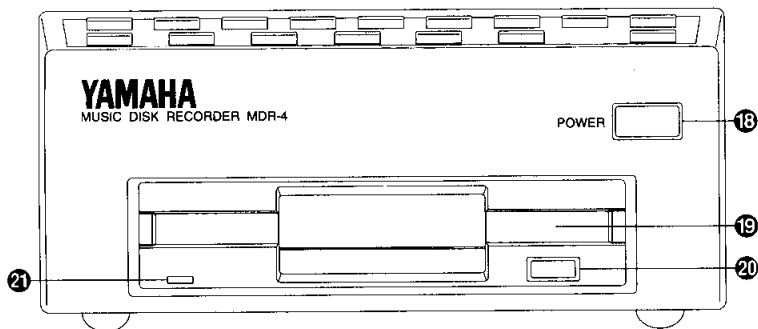

- ⑱ POWER switch
- ⑲ Disk drive slot
- ⑳ EJECT button
- ㉑ Disk drive LED

Rear Panel

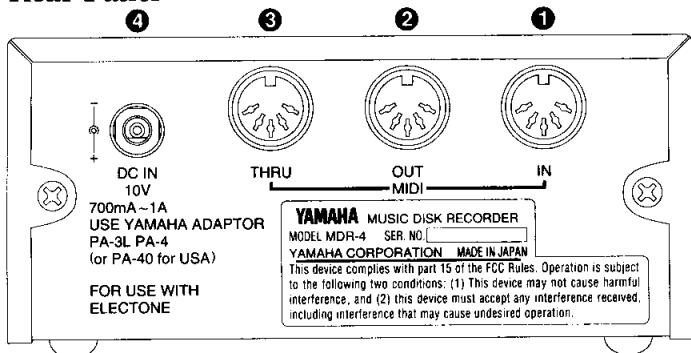

- ① MIDI IN terminal
- ② MIDI OUT terminal
- ③ MIDI THRU terminal
- ④ DC IN

Precautions

About the Power Supply and Power adaptor

● Make sure to use only the Yamaha power adaptor suitable for your area. ♦ In the U.S.A., Canada and Europe (excluding the U.K.): PA-3L, or PA-4 (PA-40 in the U.S.A.) ♦ In other areas: PA-4 ● In case of impending electrical storms, unplug the power adaptor. Never use the MDR-4 during an electrical storm. ● When not using the MDR-4 for an extended period of time, unplug the power adaptor. ● Follow normal safety precautions as you would with any other electrical appliance, such as not touching the power plug with wet hands or while standing on a wet surface, etc. ● To prevent possible damage and short-circuiting of the cord wires, always firmly hold the adaptor/plug when unplugging the adaptor; never pull on the cord.

Included Accessories:

- MIDI cables (2)
- Blank 2DD floppy disk (1)

Optional Accessories:

- PA-3L, PA-4 AC power adaptor (PA-40 in the U.S.A.)
- BRT-3 mounting bracket

Connecting the MDR-4 (Before turning on your Electone)

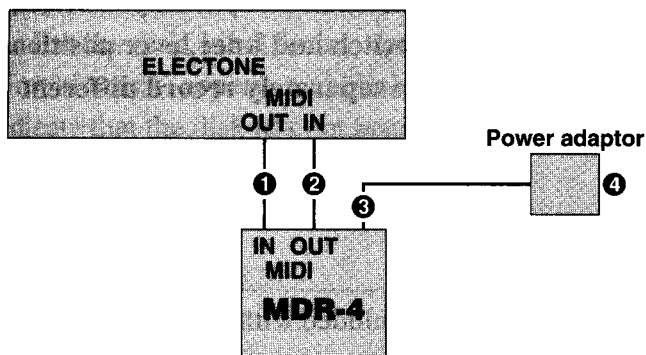

- 1 Connect the MIDI OUT terminal on the MDR-4 to the MIDI IN terminal of the Electone with one of the included MIDI cables.
- 2 Connect the MIDI IN terminal on the MDR-4 to the MIDI OUT terminal of the Electone with the other included MIDI cable.
- 3 Connect the power adaptor to the DC IN terminal.
- 4 Plug the power adaptor into an appropriate electrical outlet.

- Before connecting the MDR-4 to your Electone, make sure that the power switch of the Electone is off.
- Before moving the MDR-4, make sure to disconnect the power cord and MIDI cables.

About Data Compatibility with Other Music Disk Recorders:

Including the built-in Music Disk Recorders on the ELX-1 and EL-90/70/60 Electones, Yamaha manufactures several different Music Disk Recorder models. Compatibility between the MDR-4 and the other various models is as follows:

- Disks recorded on the upper models (the built-in Music Disk Recorders and the MDR-10) and MDR-4 are basically compatible with each other. However, some types of data recorded on the upper models are exclusive to those models and cannot be read by the MDR-4.
- Disks recorded on the MDR-3 are not compatible with those recorded on the MDR-10 or MDR-4, and vice versa.

Table of Contents

- Using Disks With the Music Disk Recorder 1
- Making a Recording 3
- Outline of M.D.R. Operation 5
- Separately Recording the Parts of a Song 5
- Recording Registrations (and Bulk Data) 8
- Recalling Recorded Registrations (and Bulk Data) 9
- Replacing Registrations 9
- Normal Playback 10
- Playback of Selected Parts 11
- Repeated Playback 12
- Other Functions 13
 - Custom Play 13
 - Pause 13
 - Fast Forward and Fast Reverse 13
 - Changing the Tempo 14
 - Song Copy 14
 - Song Delete 15
 - Checking the Remaining Memory 16
 - Copy Protect 16
- Messages on the MDR LED Display 17
- Troubleshooting 17

MDR-4 Music Disk Recorder

The MDR-4 Music Disk Recorder is a sophisticated recording device that lets you record your performances. It works like a cassette tape recorder, but it records performance data instead of sounds. The MDR-4 not only records the notes you play; it also remembers the voices and rhythms you select, the front panel controls you change, as well as all expression pedal, footswitch and knee lever positions, to reproduce your performance exactly as you play it. Moreover, you can separately record different parts of your performance, building up a song part by part.

Using Disks With the Music Disk Recorder

The M.D.R. records all your performance data to disks. A blank disk has been included with your MDR-4 for you to record your performances.

Turn the power on by pressing the POWER switch.



Inserting the disk:

Put the included disk, face up, into the disk slot under the M.D.R.

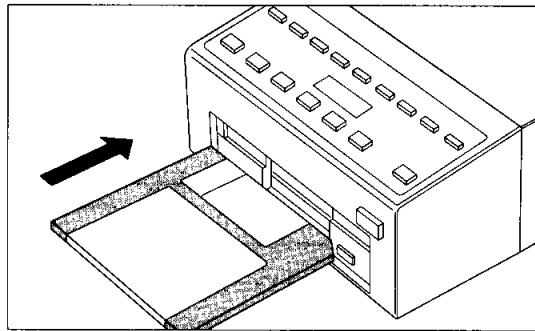

LED lights briefly when disk is inserted.

Note: Either double-sided double-density (2DD) or double-sided high-density (2HD) 3.5-inch microfloppy disks can be used with the M.D.R.

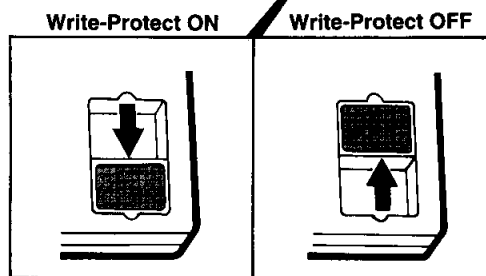
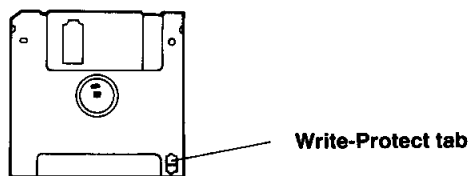

Note: When you wish to record to a disk, make sure the disk's Write - Protect tab is set to OFF. Set it to ON when you wish to protect valuable data from being accidentally erased.

Ejecting the disk:

To remove the disk, press the EJECT button next to the disk slot.

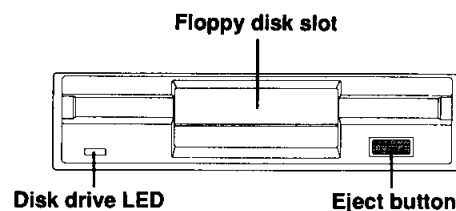

Formatting a Disk

Before recording a performance to your blank disk, the disk must first be formatted.

To format a disk:

1. Put the disk, label facing up, into the disk drive.
"Fort"(Format) appears and blinks on the LED display to indicate that the disk has not been formatted.

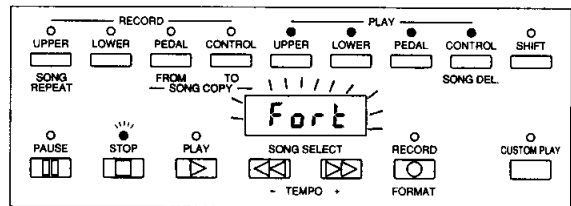

2. While holding down the SHIFT button, press the FORMAT button.

This step puts the format operation on stand-by, indicated by the dashes in the M.D.R. display and the flashing LED above the FORMAT button.

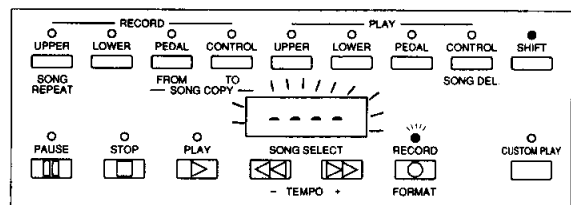

Note: If you format a disk that contains previously recorded data, all data on the disk will be erased. To avoid inadvertently formatting a disk after this step, press the STOP button.

3. Press the FORMAT button again to begin formatting.

The LED above the FORMAT button stays lit. The number "160" appears in the M.D.R. display and counts down to "001" as the disk is being formatted. When formatting is completed, operation returns to the original STOP status.

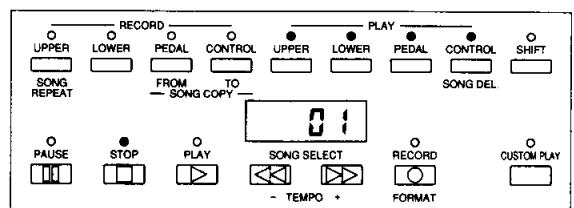
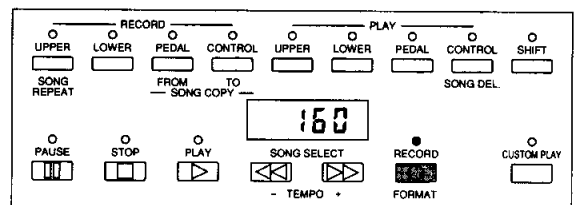

About the Shift Button

Some buttons on the M.D.R. panel have function names printed below the buttons as well as above them. The SHIFT button allows you to use these secondary functions: Simultaneously hold down the SHIFT button and press the button you wish to use.

Making a Recording

Recording with the Music Disk Recorder is as easy as using a tape recorder. In this section, you'll learn how to record your first complete performance with the Music Disk Recorder.

To record a song:

1. Set the desired registrations on the Electone.
Make all the Electone settings necessary for the song you will record. This means entering the all registrations you will need for the entire performance in the Registration Memory. Make sure also to select the registration that you will use at the beginning of the song.

2. Put a formatted disk into the disk slot.

3. Use the SONG SELECT (◀, ▶) buttons to select the song number for recording.

Up to 40 songs can be stored on a disk. When a disk is first inserted, song number 01 is automatically selected.

Note: Up to 40 songs can be stored on a disk. However, the actual number of songs may be less if some songs contain a large amount of data. (See page 16 for more information about remaining memory.)

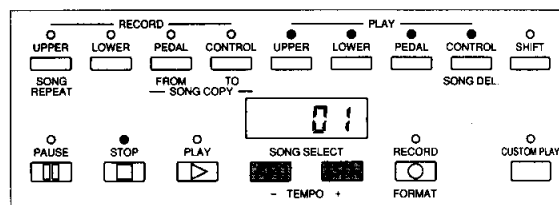

Note: If the disk has songs already recorded to it, use the SONG SELECT buttons to search for a song number that has not yet been recorded to.

4. Press the RECORD button.

The RECORD lamp lights up and the PLAY lamps begins blinking, indicating that the Music Disk Recorder is ready to record.

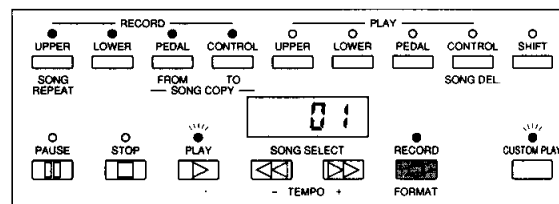

Note: If the song already contains recorded data, small bars (-) appear at the left side of the song number on the M.D.R. display, and flash along with the song number, to warn you that the selected song number has data recorded to it. To avoid erasing the data, cancel the operation by pressing the STOP button.

5. Press the PLAY button.

The PLAY lamp lights up and small bars flash across the M.D.R. display from left to right, indicating that the recorder is being set up.

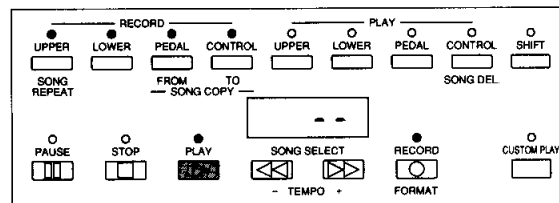

Note: In this step, the registrations and other settings on the Electone are recorded — before the recording of any performance data.

6. After numbers appear in the display of the Recorder, begin playing.

Once the setup operation in step #5 is complete, a number will appear on the recorder display indicating that you can begin recording your performance. The number also indicates the amount of memory left on the disk.

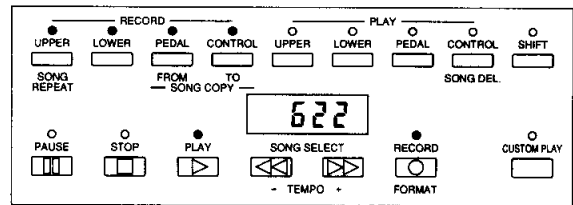

Note: The short time it takes to set up for recording is recorded as well, causing a short pause before playback of the song.

If you make a mistake during recording: Press the PLAY button while the recorder is still running...

This stops the recording and returns you to the starting point of the song. The letters "rE" (retry) appear on the left side of the M.D.R. display and the PLAY and CUSTOM PLAY LEDs start flashing, indicating that you can re-record the song.

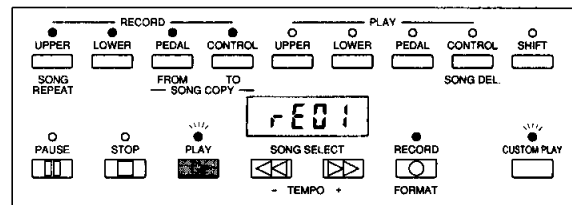

...then press PLAY again to begin re-recording the song.

Re-recording starts from the beginning of the song and replaces the previously recorded performance with the newly recorded performance.

7. When you finish playing, press the STOP button.

When the STOP button is pressed, both the RECORD and PLAY lamps go out, and recording is stopped.

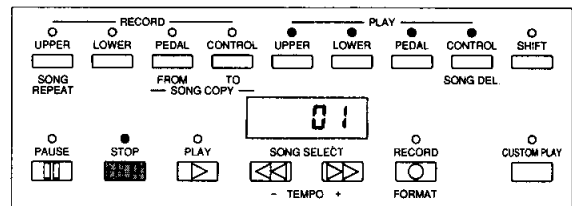

Note: When the available memory reaches "008" or less, the numbers begin flashing to warn you. If this happens, stop recording before the display reaches "000."

8. To hear your newly recorded performance, press the PLAY button.

Playback will begin after a couple of seconds.

Note: For more information on playback and other playback-related functions, see the Normal Playback section below.

Outline of M.D.R. Operation

Though the M.D.R. is as easy to operate as a cassette tape recorder, it is far more versatile. Since it records all Electone settings and control movements as well as the notes you play as digital data, it allows you much more flexibility and control than even the most sophisticated tape recorder. Basically, the M.D.R. independently records the following three types of data:

1) Registration data (including Bulk data)

All registrations stored to the Registration Memory numbered buttons as well as the registration currently set to the panel, are recorded at the beginning of a song, before the actual recording of your performance.

Bulk data is also saved to the song with the Registration data.

2) Performance data

The M.D.R. records your performance on the keyboards and pedalboard of the Electone exactly as you play it, even recording the strength at which you play the keys and how hard you press them down while playing. The various types of performance data — Upper, Lower and Pedal — are recorded to independent "tracks," so that you can change any one of them without affecting the others.

3) Control data

All changes you make on the Electone during your performance are recorded in real time. These include registration changes (excepting those made from the LCD display), and the use of the expression pedal, footswitches and knee lever.

Separately Recording the Parts of a Song

You can also record the parts of your performance independently; for example, first recording the chords and bass to the song (using the Lower and Pedal parts), and after that recording the melody. This function also lets you record keyboard percussion and performance control data, such as registration changes and expression pedal operation, separately from the other parts of the song.

To record parts separately:

1. Set up the Music Disk Recorder for recording, as you did in the section Making a Recording above.

The first steps in recording parts separately are the same as for normal recording:

- 1) Memorize all the registrations needed for your performance to the Registration Memory numbered buttons, and set the registration that will be used at the beginning of the song.
- 2) Insert a formatted disk.
- 3) Select the song number to which you will record your performance.
- 4) Press the RECORD button.

2. If you wish to, you can select individual parts for recording by pressing the appropriate RECORD buttons in the upper row. (For this example, record LOWER, PEDAL and CONTROL.)

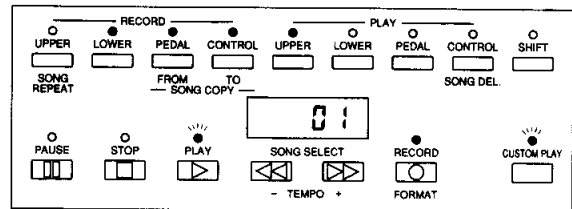

LEDs above selected parts light.

UPPER – Selects performance data of the Upper keyboard, on or off.

LOWER – Selects performance data of the Lower keyboard, on or off.

PEDAL – Selects performance data of the Pedalboard, on or off.

CONTROL – Selects Control functions (e.g., expression pedal and footswitch movements, and registration changes), on or off.

The LED lamps above the buttons indicate the record status of the parts.

This example operation disables recording of the Upper part.

Note: If you want to record any one or all of these four basic parts (Upper, Lower, Pedal and Control) at the same time, this step is actually unnecessary. Pressing the RECORD button automatically sets up the M.D.R. to record the above four parts. The Upper, Lower, Pedal and Control performance data will automatically be selected when you press the RECORD button, but only those parts that you actually play will be recorded. Later (in step #6 below), you can also record the Upper part without having to select it here in step #2.

If you wish to select the Keyboard Percussion part for separate recording:

Hold down the SHIFT button and simultaneously press the K.PERC. button in the top row. The button (indicated in the illustration at right) functions as a Keyboard Percussion selector in the record mode.

K.PERC. – Selects performance data of Keyboard Percussion. (Keyboard Percussion can be recorded and played independent of the Rhythm patterns.)

Holding down the SHIFT button in the record condition lets you select this "hidden" function. The lamp above the button will also change to indicate the status of the SHIFT- selected part.

[Hidden Functions on MDR]

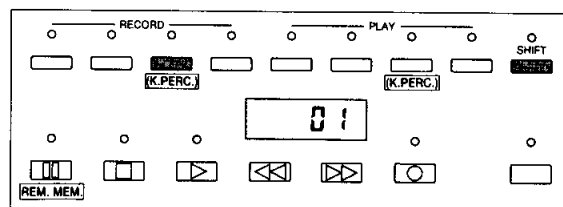

Note: The Keyboard Percussion part can be selected for playback in the Play or Record functions by using the button in the PLAY section (indicated in the illustration above).

Note: When recording or playing back the Keyboard Percussion part, make sure the Keyboard Percussion button on the Electone is turned off. Otherwise, the Keyboard Percussion sounds will be played twice, resulting in cancellation of some sounds and a strange "flanging" sound in others. (This does not apply to the HX- series Electones.)

3. Press the PLAY button, and start playing after numbers appear in the display.

For this example, play the lower keyboard and pedalboard. Press the STOP button when you are finished with your performance to stop recording.

Note: The Lead voices cannot be recorded separately.

4. Now that you've recorded the first parts of your performance, press **RECORD** to set up recording of the next part.

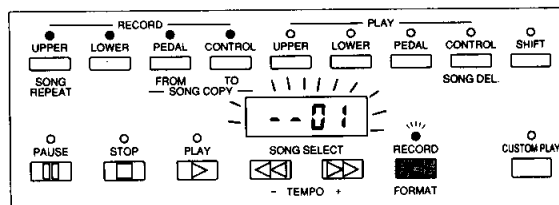

Note: Since the song now contains recorded data of the Lower and Pedal parts (recorded in step #2), small bars ("--") appear at the leftmost part of M.D.R. display and flash along with the song number, warning you that the selected song number already contains recorded data.

5. Press the **RECORD** button again and switch the parts you recorded in step #2 to Play in the **PLAY** section.

The **PLAY** and **CUSTOM PLAY** LEDs start flashing, indicating the stand-by status.

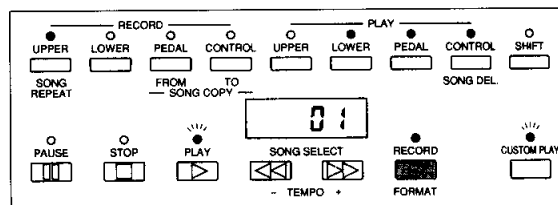

Note: If you want to record the Keyboard Percussion part separately, or if you want to re-record any individual parts, you should select those parts here before going to the next step: (See step #2 above.)

6. Press the **CUSTOM PLAY** button to start recording of the new part or parts.

Playback of the previously recorded parts starts immediately.

The **CUSTOM PLAY** button is used here to record only the parts that have been selected for recording, and play back only those parts that have been selected for playback. Since registration data has already been recorded with the first parts of the song, recording begins immediately.

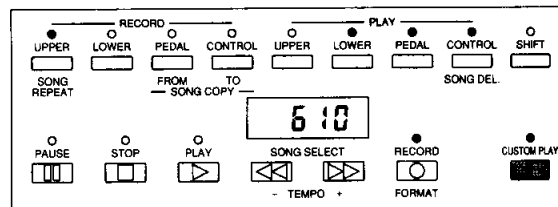

Note: The length of a subsequently recorded part cannot exceed the length of the previously recorded parts.

7. While you listen to the parts being played back, start playing the melody on the Upper keyboard.

When the end of the recorded performance is reached, playback is automatically stopped and the STOP status is resumed.

Recording Registrations (and Bulk Data)

You can also record registrations by themselves, without recording a performance. Bulk data, including Registration Memory and Registration Shift settings, and User voices, is also saved in the operation.

To record only the registrations:

1. On the Electone, set the registrations and all other data you wish to record.

2. Select the song number to which you wish to record the registrations.

If the selected song number already contains recorded data, select another song number.

3. Press the RECORD button.

Note: Songs that already contain recorded data are indicated by small bars on the left side of the M.D.R. display, when the RECORD button is pressed in the next step. (See page 3.)

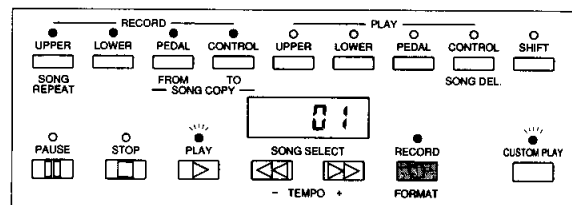

4. Press the PLAY button to record the registrations, then press the STOP button as soon as you see the small bars flash across the M.D.R. display.

The small bars that flash across the display indicate that the M.D.R. is being set up for normal recording; pressing the STOP button interrupts this process. The bars then flash simultaneously, indicating that only registration and other data is being recorded.

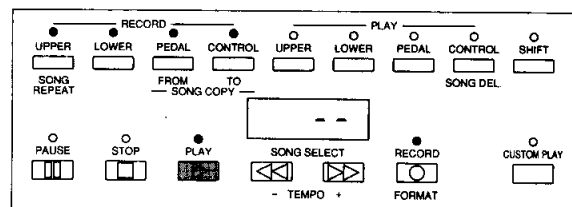

Recalling Recorded Registrations (and Bulk Data)

The registrations (and bulk data) recorded to song numbers in the above operation can be loaded back to the Electone by simply selecting the appropriate song number and pressing the PLAY button.

When the operation has been completed, the M.D.R. returns to STOP status.

The M.D.R. also makes it possible to use more than the 5 Registration Memory registrations in a performance — without having to alter the current panel settings. This would come in handy when performing several songs in succession that use more than 5 registrations.

To do this:

- 1.** First record the registrations you need into several song numbers on the M.D.R. before the performance. (You should also try to record them in the order that you'll use them, if possible.)
- 2.** During the performance, after all 5 registrations from a certain song number have been used, select the next song number and press the PLAY button on the M.D.R. This replaces all 5 registrations in Registration Memory with the new ones from the selected song number.
- 3.** By repeating the above steps, you can run through an entire performance without having to change the panel settings.

Replacing Registrations

The M.D.R. also lets you change the registrations of an existing song without changing the performance data. The procedure is the same as that of Recording Registrations mentioned in the previous page.

Normal Playback

You can play back your recorded performance by simply pressing the PLAY button. Registrations and other data will be recalled to the Electone.

To play back a song:

1. Select the number of the song you wish to play back by using the SONG SELECT buttons.

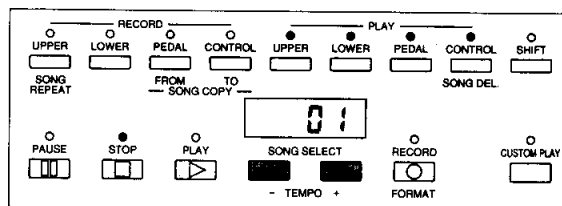

Note: The Keyboard Percussion part is automatically selected for playback in this operation, and the LED above the K.PERC. button in the PLAY section lights.

2. Press the PLAY button.

The PLAY lamp lights up and a small bar moves across the display, indicating that the Recorder is resetting registrations on the Electone.

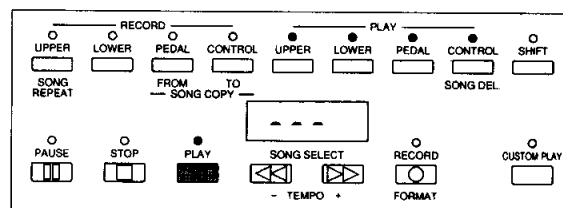

Note: The time required to reset the registrations is the same as the time required during recording.

3. Playback of the song begins after the Electone data is reset and the song time is shown on the recorder's display.

Playback automatically stops at the end of a song. You can, however, stop playback in the middle of a song by pressing the STOP button.

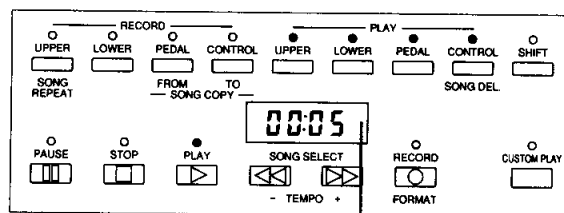

Elapsed time of song

Note: Never turn off the power switch when a floppy disk is still engaged in the MDR disk drive slot. Also do not press the Eject button during recording or playback.

Playback of Selected Parts

You can also play back selected parts of your recorded performance, while other parts are temporarily turned off. This function is especially useful for playing a single part, such as the melody, over previously recorded accompaniment parts.

To select specific parts for playback:

- 1. Select the number of the song to be played back.**

- 2. Set the parts you wish to mute to OFF, by pressing the appropriate PLAY button. The LED of the selected part should be off.**

- 3. Select the parts you wish to play back by setting them to ON.**

- 4. Press the PLAY button.**
First the PLAY LED lights and the registration and other data are transmitted, then playback of the performance starts (excepting the parts that were turned off in step #2).

- 5. Now perform your new part or parts over the playback parts.**
When the end of the recorded performance is reached, playback is automatically stopped and the STOP status is resumed.

Repeated Playback

This feature allows you to repeatedly play back either all songs on a disk or only one specific song.

To repeat playback of a song or songs:

1. Select the song number you wish to play back.

If you wish to play back all songs on a disk, this selects the first song that will be played back. The others will follow in order.

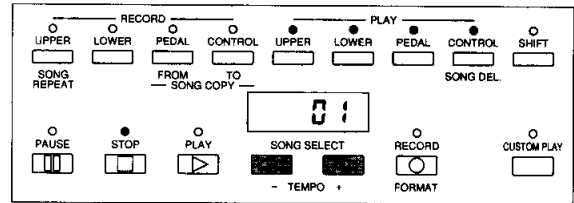

2. Hold down the SHIFT button and simultaneously press the SONG REPEAT button.

The LEDs above SHIFT and SONG REPEAT light up, and "ALL" appears in the M.D.R. display.

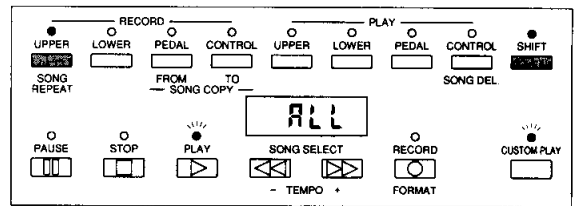

To repeatedly playback all songs starting with the selected song:

Press the PLAY button at this point (go to step #3 below).

To repeatedly playback only the selected song:

Again hold down the SHIFT button and simultaneously press the SONG REPEAT button.

"SinG" appears in the M.D.R. display to indicate that a single song will be repeatedly played back.

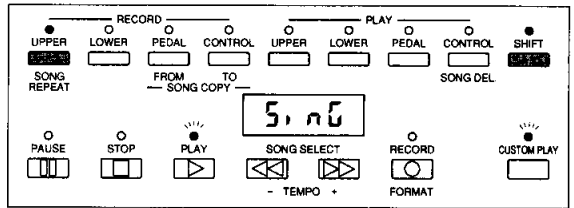

3. Press the PLAY button to begin playback of the song or songs.

Playback will begin from the song selected and repeat indefinitely. To stop playback, press the STOP button.

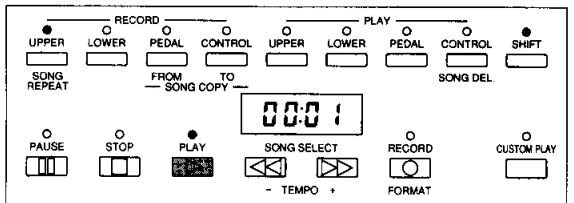

Other Functions

Custom Play

If you want to play back the song without resetting the registrations and other data, press the CUSTOM PLAY button. This displays the song time and starts playback immediately.

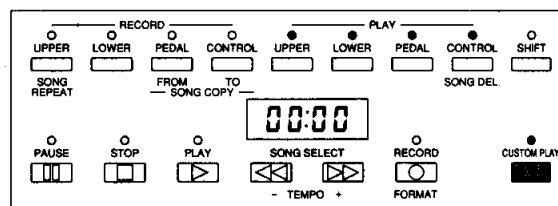

Pause

If you want to temporarily stop playback of the song or songs, press the PAUSE button. To resume playback from the point at which the song was paused, press the PAUSE button again.

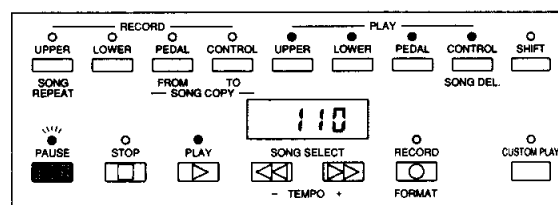

Fast Forward and Fast Reverse

During playback, these buttons function as fast forward and fast reverse buttons, much like those of a tape recorder. Press ►► to advance to a later point in the song or press ◀◀ to return to an earlier position. While either of these buttons is held down, playback stops and the song time is advanced or reversed accordingly. Hold down the button until the desired song time is shown. When the button is released, playback is paused. To resume playback from the point you've advanced or reversed to, press the PLAY button.

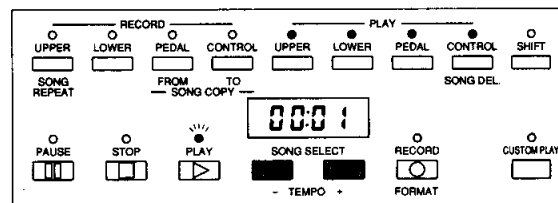

Note: Fast Forward and Fast Reverse operate at five times the normal playback speed.

Changing the Tempo

You can change the tempo of the song as the song is playing on the M.D.R. by holding down the SHIFT button and pressing the TEMPO + or TEMPO - button. (The Tempo dial on the Electone panel cannot be used to change the tempo on the Music Disk Recorder.)

Each press of the button slows down or speeds up the tempo by a small amount. Changing the tempo does not change the pitch of the music.

7102

Indicates faster tempo

+100

Indicates original tempo

98

Indicates slower tempo

To restore the original recording tempo of a song, hold down the SHIFT button and simultaneously press both TEMPO buttons.

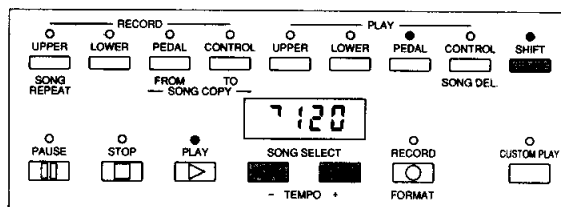

Note: When tempo is changed, the M.D.R. display indicates the change as a percentage of the original recording tempo (100). Values less than 100 indicate a slower tempo; values greater than 100 indicate a faster tempo.

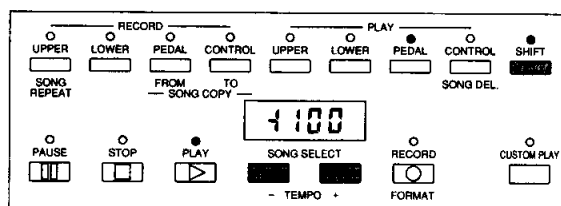

Note: Tempo changes remain in effect even through changes in song number. If you have changed the tempo in one song, you should perform the above step to restore the original tempo before playing another song. Turning the power switch off and on again also restores the original tempo.

Song Copy

This function lets you copy the data recorded at one song number to another song number.

To use the Song Copy function:

1. Select the song number to be copied with the SONG SELECT buttons.
2. While holding down the SHIFT button, press the SONG COPY FROM button.

The song number to be copied from appears at the left of the M.D.R. display.

Note: If the specified song number has no recorded data, the M.D.R. automatically searches for and selects the next song that contains recorded data.

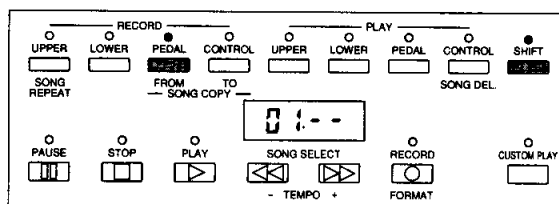

3. While holding down the SHIFT button, press the SONG COPY TO button.

The M.D.R. automatically searches for an empty song number to copy the data to, and displays that number at the right side of the display. If all song numbers contain recorded data, "FULL" appears on the M.D.R. display. In this case, you should erase one of the songs on the disk by using the Song Delete function (see below).

4. Use the SONG SELECT buttons to select a destination song number for copying.

Follow this step if you wish to select a different destination song number than the one displayed. The M.D.R. will display only those song numbers that have no data.

5. Press the RECORD button to execute the Song Copy function.

The RECORD LED stops flashing and remains lit, indicating that the Song Copy function is in process. The M.D.R. display shows the "size" of the song in numbers, and counts down as the data is being copied. When the display shows "000", the song has been completely copied.

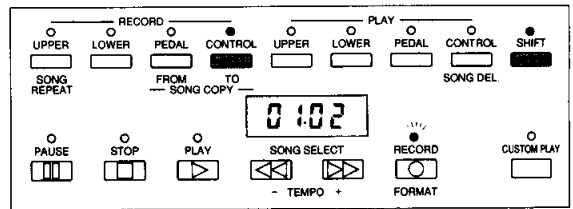

Note: To cancel this operation at any time, press the STOP button.

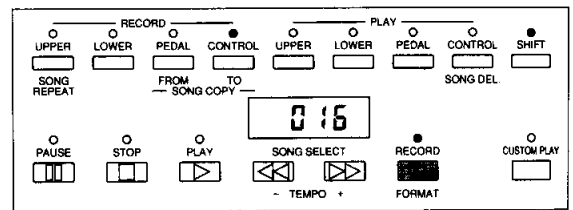

Song Delete

You can erase a song on disk by performing this function.

To use Song Delete:

1. Use the SONG SELECT buttons to select the number of the song you wish to delete.

2. While holding down the SHIFT button, press the SONG DEL. button.

The letters "dL" appear on the left side of the M.D.R. display, next to the selected song number. If you wish to, you can still select a different song number in this step by using the SONG SELECT buttons.

3. Press the RECORD button to execute the Song Delete function.

The RECORD LED stops flashing and remains lit, indicating that the Song Delete function has begun. When the Song Delete function is completed, the STOP status is automatically resumed.

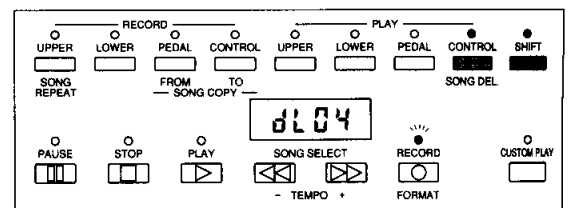

RECORD LED flashes to indicate that the M.D.R. is ready to delete the song.

Note: If you want to cancel the operation (before executing step #3 below), press the STOP button.

Checking the Remaining Memory

While playback is stopped, you can check the amount of memory available for additional recording. To do this, simultaneously hold down the SHIFT button and the PAUSE button (indicated in the illustration at right as REM.MEM.). The maximum amount of memory is 620 for 2DD disks or 1240 for 2HD disks.

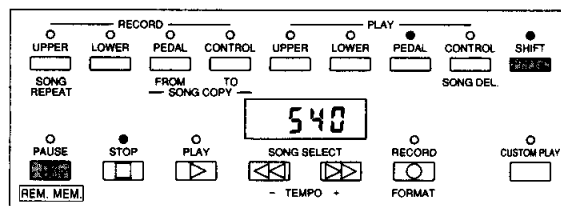

Copy Protect

Some of the Disks available for the Electone are deliberately protected from being copied or erased. If you try to load data from such as "copy-protected" disk to the Electone, a "Protected Disk!" (Pr##) message will appear on the LED display. The data cannot be saved to the disk.

About Floppy Disk Care and Use

■ Do NOT eject the disk during recording or playback or while the disk drive LED is on.

Doing so may damage both the disk and the M.D.R.

■ Do NOT turn off the Electone while the disk is still inserted. Always eject the disk before turning off the Electone.

■ When ejecting a floppy disk from the disk slot:

- To eject a floppy disk, press the eject button slowly as far as it will go. Then, when the disk is fully ejected, remove it by hand.
- The disk may not be ejected properly if the eject button is pressed too quickly, or if it is not pressed in far enough. (The eject button may become stuck halfway with the disk extending from the slot by only a few millimeters.) If this is the case, do not attempt to pull out the partially ejected disk. Doing so may damage the disk drive mechanism and/or the floppy disk. To remove a partially ejected disk, try pressing the eject button once again, or push the disk back into the slot, then repeat the eject procedure carefully.
- Do not insert anything but floppy disks into the disk drive. Other objects may cause damage to the disk drive or floppy disk.

■ Dirt and dust accumulate on the head of the disk drive unit during the course of normal use, and may cause errors in reading/writing of data. You should periodically clean the head with a 3.5-inch head cleaning disk.

■ Disk Compatibility

- Use either double-sided double-density (2DD) or double-sided high-density (2HD) 3.5-inch microfloppy disks with the M.D.R.

■ Precautions on Floppy Disk Use

- Never open the disk's shutter. Dirt or dust on the internal magnetic surface will cause data errors.
- Never leave disks near a speaker, TV or other device that emits a strong magnetic field.
- Do not store disks in places exposed to direct sunlight or sources of high temperature.
- Do not place heavy objects, such as books or notebooks, on top of the disks.
- Avoid getting the disks wet.
- Make sure to store the disks in environmental conditions as specified below:
 - Storage temperature: 4° to 53°C (39° to 127°F)
 - Storage humidity: 8 to 90% relative humidity
 - Location where disks are unlikely to be exposed to dust, sand, smoke, etc.
- Be sure to apply the label at the proper position. When changing the label, never cover the old label with a new label; always remove the new label first.

Messages on the MDR LED display

Display	Description of the Messages
Inst	No disk is installed. Install a disk.
Formt	The installed disk is not formatted. Format the disk. (See page 56.)
Prot	1) The installed disk is write-protected, so the Record, Song Copy, and Song Delete jobs cannot be performed. Set the disk's write Protect tab to the OFF position. (See page 55.) 2) If you are using a copy-protected playback-only disk, this message may appear when you attempt the Record, Song Copy, or Song Delete operations.
FULL	1) The disk's memory capacity is full, so the Record or Song Copy operation cannot be performed. Install another formatted disk. 2) Data is already recorded at all song numbers, so the Song Copy operation cannot be performed. Press the STOP button, then delete any unnecessary songs.
Empty	None of the song numbers contain recorded data, so the Song Copy operation cannot be performed. Press the STOP button.
-out	An error occurred because the disk was removed during recording or playback. Replace the disk, press the STOP button, then start the operation over again.
disc	The installed disk cannot be played back on the M.D.R. Press the STOP button, then insert a compatible disk.
lots	Recording cannot be performed because too much data was received at once. Press the STOP button.
bad	The disk is defective and cannot be formatted. Press the STOP button, then insert another disk.
Error	An error occurred during the transmission or reception of data. Press the STOP button.
db##	This indicates that two kinds of registration data are recorded to the song number which is currently displayed. Press the [PLAY] button again to start playback.
0000	This indicates that an incompatible disk has been inserted. Insert a compatible disk. It may also indicate problems with MIDI data; check that the MIDI cables are properly connected.

Troubleshooting

Problem	Possible Cause and Solution
Recording or playback cannot be performed.	1) Problems in recording or playback may be caused by improper operation of the M.D.R. Refer to the LED Display Messages chart above. 2) The PLAY or RECORD section buttons for selecting parts may be turned off. Turn on the appropriate PLAY or RECORD buttons.
A total of 40 songs cannot be recorded.	If some song numbers contain a large amount of recorded data, the disk may not have enough available memory left to record the normal maximum of 40 songs.
Recording is stopped before the performance is finished, or the Song Copy function cannot be executed.	The amount of recorded data on the disk is close to the maximum limit. Either use another disk or delete the data of any unnecessary song number. (See page 15.)
The Keyboard Percussion part has not been recorded, or plays back a different rhythm from the one recorded.	When recording, you forgot the following operation: press the RECORD button, then hold down the SHIFT button while you press the PEDAL button (selecting Keyboard Percussion). Other causes may be involved, so refer to the procedure for recording parts separately. (See page 5.)
The rhythm does not start at the beginning of a recording, or stops in the middle of the performance.	The M.D.R. is designed so that the rhythm cannot be started at the very beginning of a recording. If you wish to use the rhythm, start it after the available memory display appears on the M.D.R. display.
The notes of the recording are "stuck" and sound continuously.	During playback, you removed the disk by pressing the EJECT button. Whenever you wish to stop playback, always press the STOP button.

Specifications

Model:	Music Disk Recorder
Recording media:	3.5-inch microfloppy disks (2DD/2HD)
Disk format:	PC-DOS
Memory capacity:	620/1240K bytes/40 songs maximum
Controls:	RECORD/FORMAT, SONG SELECT/TEMPO +/▶▶, SONG SELECT/TEMPO -/◀◀, PLAY/CUSTOM PLAY, STOP, PAUSE. RECORD Section: UPPER/SONG REPEAT, LOWER, PEDAL/SONG COPY FROM, CONTROL/SONG COPY TO. PLAY Section: UPPER, LOWER, PEDAL, CONTROL/SONG DEL., SHIFT.
Display:	Four-digit seven-segment LED
Other components:	POWER switch, disk drive, EJECT button
Input/Output jacks:	MIDI IN, MIDI OUT, MIDI THRU, DC IN.
Rated input voltage:	10 V DC
Rated input current:	Minimum 700 mA up to 1A
Rated power consumption:	9.5 W
External dimensions:	135 (W)× 200 (D)× 63.5 (H) mm (5¼"× 7⅞"× 2½")
Weight:	1.3 kg (2 lbs., 14 oz.)
Accessories:	3.5-inch 2DD microfloppy disk× 1 MIDI cable (1.5m length)× 2
Options:	Mounting bracket BRT-3 Power adaptor PA-3L or PA-4 (PA-40 for the USA)

[Reference: Names of the Created Files]

Registration files	MDR_nn.ROO MDR_nn.BOO
Event files	MDR_nn.EVT *nn=00 to 39 (Song Nos. 01 to 40)

MIDI Data Transferred during Recording/Playback
MIDI-Datenübertragung bei Aufnahme/Wiedergabe
Données MIDI transférées pendant l'enregistrement/lecture
Datos de MIDI transferidos durante la grabación/reproducción

During Recording / Bei Aufnahme / Pendant l'enregistrement / Durante la grabación

Electone

MDR-4

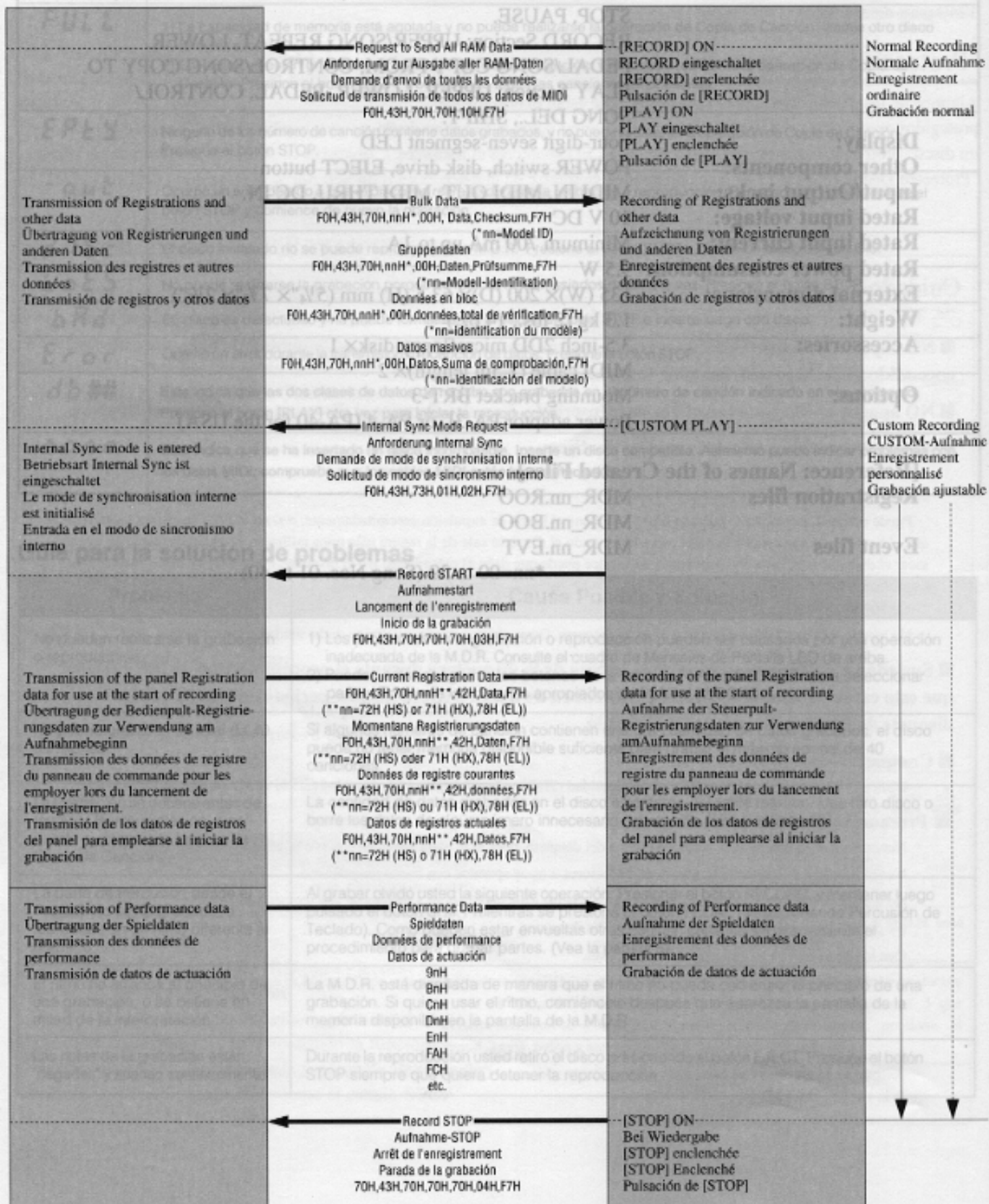

During Playback / Bei Aufnahme / Pendant la lecture / Durante la reproducción

Electone

MDR-4

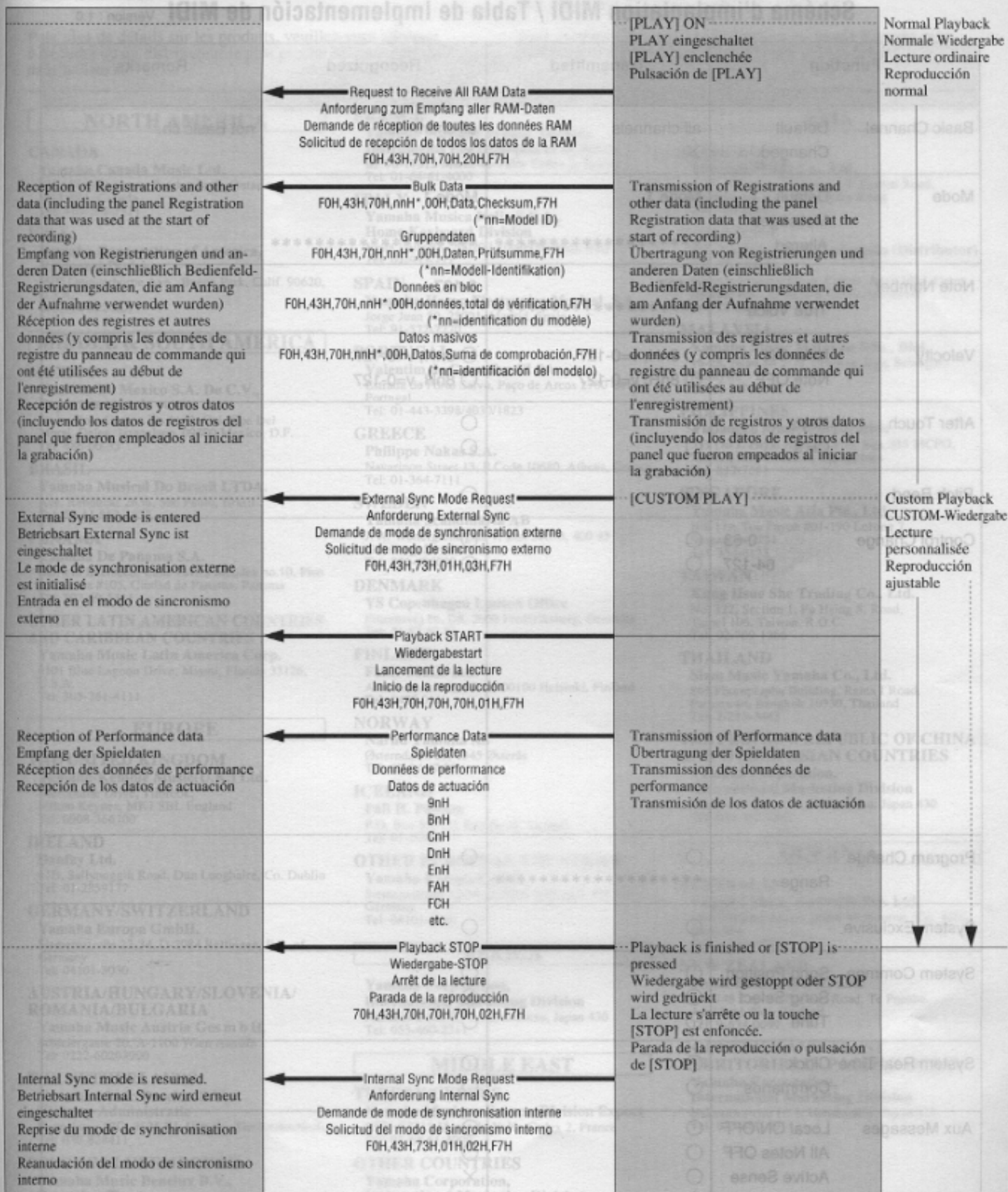

*In case Bulk data is not successfully transmitted by MDR-4 or received by the Electone, an Unacknowledge (NAK) signal (FOH, 43H, 70H, 70H, 38H, 00H, F7H) is sent from the Electone to MDR-4, then MDR-4 transmits the Bulk data once more. If the second attempt to transfer Bulk data is also unsuccessful, the operation will be discontinued.

*Wenn Gruppendaten nicht erfolgreich durch MDR-4 übertragen oder vom Electone empfangen werden, wird ein Nicht-Erkant-Signal (NAK) (FOH, 43H, 70H, 70H, 38H, 00H, F7H) vom Electone zum MDR-4 ausgegeben, und MDR-4 gibt die Gruppendaten erneut aus. Wenn auch der zweite Versuch zur Übertragung von Gruppendaten erfolglos ist, wird das Verfahren abgebrochen.

*Au cas où les données en bloc ne seraient pas transmises par le MDR-4, ou pas reçues par l'Electone, un signal de non reconnaissance (NAK="unacknowledge") (FOH, 43H, 70H, 70H, 38H, 00H, F7H) est envoyé de l'Electone au MDR-4, puis le MDR-4 envoie à nouveau les données en bloc. Si la deuxième tentative d'envoi des données en bloc échoue, cette opération va s'interrompre.

*En caso de que el MDR-4 no transmita satisfactoriamente los datos masivos o de que el Electone no los reciba, el Electone enviará al MDR-4 una señal de ausencia de recibo (NAK) (FOH, 43H, 70H, 70H, 38H, 00H, F7H), después de lo cual el MDR-4 transmitirá una vez más los datos masivos. Si el segundo intento de transferencia de datos masivos resulta también insatisfactorio, la operación cesará.

MUSIC DISK RECORDER MDR-4

MIDI Implementation Chart / MIDI Implementation Chart

Schéma d'implantation MIDI / Tabla de implementación de MIDI

Date : 10/16, 1992

Version : 1.0

Function		Transmitted	Recognized	Remarks
Basic Channel	Default Changed	all channels X	all channels X	not Basic ch.
Mode	Default Messages Altered	Mode 1 *****	Mode 1 *****	
Note Number	True Voice	0-127 *****	0-127	
Velocity	Note ON Note OFF	<input type="radio"/> 9nH, v=0-127 <input type="radio"/> 8nH, v=0-127	<input type="radio"/> 9nH, v=0-127 <input type="radio"/> 8nH, v=0-127	
After Touch	Key's CH's	<input type="radio"/> <input type="radio"/>	<input type="radio"/> <input type="radio"/>	
Pitch Bend		<input type="radio"/>	<input type="radio"/>	
Control Change	0-63 64-127	<input type="radio"/> <input type="radio"/>	<input type="radio"/> <input type="radio"/>	
Program Change	Range	<input type="radio"/> *****	<input type="radio"/>	
System Exclusive		<input type="radio"/>	<input type="radio"/>	
System Common	Song Position Song Select Tune	<input type="radio"/> <input type="radio"/> <input type="radio"/>	<input type="radio"/> <input type="radio"/> <input type="radio"/>	
System Real Time	Clock Commands	<input type="radio"/> <input type="radio"/>	<input type="radio"/> <input type="radio"/>	
Aux Messages	Local ON/OFF All Notes OFF Active Sense Reset	<input type="radio"/> <input type="radio"/> <input type="radio"/> <input type="radio"/>	<input type="radio"/> <input type="radio"/> X X	
Notes				

Mode 1 : OMNI ON, POLY
Mode 3 : OMNI OFF, POLY

Mode 2 : OMNI ON, MONO
Mode 4 : OMNI OFF, MONO

: Yes
 : No

For details of products, please contact your nearest Yamaha or the authorized distributor listed below.

Die Einzelheiten zu Produkten sind bei Ihrer unten aufgeführten Niederlassung und bei Yamaha Vertragshändlern in den jeweiligen Bestimmungsländern erhältlich.

Pour plus de détails sur les produits, veuillez-vous adresser à Yamaha ou au distributeur le plus proche de vous figurant dans la liste suivante.

Para detalles sobre productos, contacte su tienda Yamaha más cercana o el distribuidor autorizado que se lista debajo.

NORTH AMERICA

CANADA

Yamaha Canada Music Ltd.
135 Milner Avenue, Scarborough, Ontario,
M1S 3R1, Canada
Tel: 416-298-1311

U.S.A.

**Yamaha Corporation of America,
Keyboard Division**
6600 Orangethorpe Ave., Buena Park, Calif. 90620,
U.S.A.
Tel: 714-522-9011

MIDDLE & SOUTH AMERICA

MEXICO

**Yamaha De Mexico S.A. De C.V.,
Departamento de ventas**
Javier Rojo Gomez No.1149, Col. Gpe Del
Moral, Deleg. Iztapalapa, 09300 Mexico, D.F.
Tel: 686-00-33

BRASIL

Yamaha Musical Do Brasil LTDA.
Ave. Reboucas 2636, São Paulo, Brasil
Tel: 55-11 853-1377

PANAMA

Yamaha De Panama S.A.
Edificio Interseco, Calle Elvira Mendez no.10, Piso
3, Oficina #105, Ciudad de Panama, Panama
Tel: 507-69-5311

OTHER LATIN AMERICAN COUNTRIES AND CARIBBEAN COUNTRIES

Yamaha Music Latin America Corp.
6101 Blue Lagoon Drive, Miami, Florida 33126,
U.S.A.
Tel: 305-261-4111

EUROPE

THE UNITED KINGDOM

Yamaha-Kemble Music(U.K.) Ltd.
Sherbourne Drive, Tilbrook,
Milton Keynes, MK7 8BL England
Tel: 0908-366700

IRELAND

Danfay Ltd.
61D, Sallynoggin Road, Dun Laoghaire, Co. Dublin
Tel: 01-2859177

GERMANY/SWITZERLAND

Yamaha Europa GmbH.
Siemensstraße 22-34, D-2084 Rellingen, F.R. of
Germany
Tel: 04101-3030

AUSTRIA/HUNGARY/SLOVENIA/ ROMANIA/BULGARIA

Yamaha Music Austria Ges m b H.
Schleiergasse 20, A-1100 Wien Austria
Tel: 0222-60203900

THE NETHERLANDS

**Yamaha Music Benelux B.V.,
Verkoop Administratie**
Kannalweg 18G, 3526 KL Utrecht, The Netherlands
Tel: 030-828411

BELGIUM/LUXEMBOURG

**Yamaha Music Benelux B.V.,
Brussels-office**
Keiberg Imperiastraat 8, 1930 Zaventem, Belgium
Tel: 02-7258220

FRANCE

**Yamaha Musique France, Division
Instruments Electroniques et de Scène**
BP 70-77312 Marne-la-Valée Cedex 2, France
Tel: 01-64-61-4000

ITALY

**Yamaha Musica Italia S.P.A.,
Home Keyboard Division**
Viale Italia 88, 20020 Lainate(Milano), Italy
Tel: 02-935-771

SPAIN

Yamaha-Hazen Electronica Musical, S.A.
Jorge Juan 30, 28001, Madrid, Spain
Tel: 91-577-7270

PORTUGAL

Valentim de Carvalho CI SA
Estrada de Porto Salvo, Paço de Arcos 2780 Oeiras,
Portugal
Tel: 01-443-3398/4030/1823

GREECE

Philippe Nakas S.A.
Navarinou Street 13, P.Code 10680, Athens, Greece
Tel: 01-364-7111

SWEDEN

Yamaha Scandinavia AB
J. A. Wettergrens gata 1, Box 30053, 400 43
Göteborg, Sweden
Tel: 031-496090

DENMARK

YS Copenhagen Liaison Office
Finsensvej 86, DK-2000 Frederiksberg, Denmark
Tel: 31-87 30 88

FINLAND

Fazer Music Inc.
Aleksanterinkatu 11, SF 00100 Helsinki, Finland
Tel: 0435 011

NORWAY

Narud Yamaha AS
Østerdalen 29, 1345 Østerås
Tel: 02-24 47 90

ICELAND

Páll H. Pálsson
P.O. Box 85, 121 Reykjavik, Iceland
Tel: 01-19440

OTHER EUROPEAN COUNTRIES

Yamaha Europa GmbH.
Siemensstraße 22-34, D-2084 Rellingen, F.R. of
Germany
Tel: 04101-3030

AFRICA

**Yamaha Corporation,
International Marketing Division**
Nakazawa-cho 10-1, Hamamatsu, Japan 430
Tel: 053-460-2311

MIDDLE EAST

TURKEY/CYPRUS

Yamaha Musique France, Division Export
BP70-77312 Marne-la-Valée Cedex 2, France
Tel: 01-64-61-4000

OTHER COUNTRIES

**Yamaha Corporation,
International Marketing Division**
Nakazawa-cho 10-1, Hamamatsu, Japan 430
Tel: 053-460-2311

ASIA

HONG KONG

Tom Lee Music Co., Ltd.
11/F., Silvercord Tower 1, 30 Canton Road,
Tsimshatsui, Kowloon, Hong Kong
Tel: 730-1098

INDONESIA

**PT. Yamaha Music Indonesia (Distributor)
PT. Nusantik**
Gedung Yamaha Music Center, Jalan Jend. Gatot
Subroto Kav. 4, Jakarta 12930, Indonesia
Tel: 21-520-2577

MALAYSIA

Yamaha Music Malaysia Sdn., Bhd.
16-28, Jalan SS 2/72, Petaling Jaya, Selangor,
Malaysia
Tel: 3-717-8977

PHILIPPINES

Yupangco Music Corporation
339 Gil J. Puyat Avenue, P.O. Box 885 MCPO,
Makati, Metro Manila, Philippines
Tel: 819-7551

SINGAPORE

Yamaha Music Asia Pte., Ltd.
Blk 17A Toa Payoh #01-190 Lorong 7
Singapore 1231
Tel: 354-0133

TAIWAN

Kung Hsue She Trading Co., Ltd.
No. 322, Section 1, Fu Hsing S. Road,
Taipei 106, Taiwan. R.O.C.
Tel: 02-709-1266

THAILAND

Siam Music Yamaha Co., Ltd.
865 Phornprapha Building, Rama I Road,
Patumwan, Bangkok 10330, Thailand
Tel: 2-215-3443

THE PEOPLE'S REPUBLIC OF CHINA AND OTHER ASIAN COUNTRIES

**Yamaha Corporation,
International Marketing Division**
Nakazawa-cho 10-1, Hamamatsu, Japan 430
Tel: 053-460-2311

OCEANIA

AUSTRALIA

Yamaha Music Australia Pty. Ltd.
17-33 Market Street, South Melbourne, Vic. 3205,
Australia
Tel: 3-699-2388

NEW ZEALAND

Music Houses of N.Z. Ltd.
146/148 Captain Springs Road, Te Papapa,
Auckland, New Zealand
Tel: 9-634-0099

COUNTRIES AND TRUST TERRITORIES IN PACIFIC OCEAN

**Yamaha Corporation,
International Marketing Division**
Nakazawa-cho 10-1, Hamamatsu, Japan 430
Tel: 053-460-2311

HEAD OFFICE Yamaha Corporation, Electronic Musical Instrument Division
Nakazawa-cho 10-1, Hamamatsu, Japan 430
Tel: 053-460-3251

YAMAHA
YAMAHA CORPORATION