

PROFESSIONAL SERIES POWER AMPLIFIER

PC2002/2002M

OPERATING MANUAL

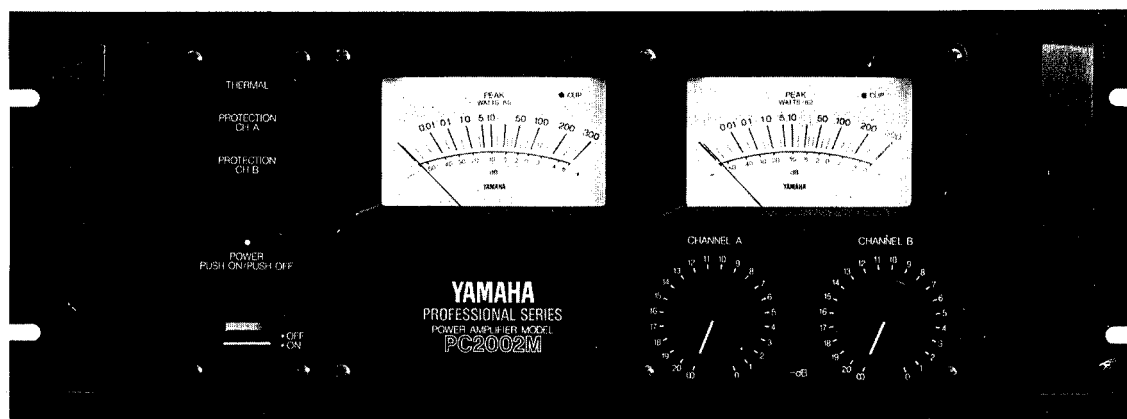

YAMAHA

ABOUT THIS MANUAL

SCOPE

The PC2002M is a system oriented amplifier, made to be used in conjunction with mixers, consoles, frequency dividing networks and speakers – those made by Yamaha or by other manufacturers. Like any power amplifier, the PC2002M's performance depends on system design and installation, in addition to its own capabilities. Thus, the PC2002M Operating Manual is system oriented, describing system design parameters and installation techniques, as well as operation and performance of the PC2002M.

ORGANIZATION

*We recommend that you read the entire Operating Manual. However, if you are using the PC2002M in an existing system, and you are familiar with high power amplifiers, the **BRIEF OPERATING INSTRUCTIONS**, Pages 2 & 3, contain all the information necessary for basic connections and operation.*

***NOTE:** The PC2002 is identical to the PC2002M except there are no Peak Reading Meters.*

CONTENTS

INTRODUCTION	1
BRIEF OPERATING INSTRUCTION	2, 3
GENERAL SPECIFICATIONS	4
PERFORMANCE GRAPHS	5, 6
A DISCUSSION OF SPECIFICATIONS	7 ~ 9
MOUNTING	10
BLOCK DIAGRAM	11
DIMENSIONS	12

INTRODUCTION

The PC2002M is not just "another big amplifier", it is an exciting new approach to high power sound. Yamaha's leadership is clearly demonstrated by the PC2002M's professional features, sophisticated design, and uncompromising performance.

PEAK READING METERS*

Instead of the more common and slow responding VU meters, the PC2002M has PEAK READING METERS that accurately display a full five decades (50dB) of output level. The peak meters have large, illuminated faces marked with dB and with watts into 8 ohms. The fast responding meters provide a better way to see the program dynamics, the transient power demands placed on the system, and the available headroom. By indicating headroom, the meters help the operator avoid over-driving the system, thereby preventing the "clipped" waveforms so dangerous to drivers and loudspeakers.

CALIBRATED INPUT ATTENUATORS

The PC2002M has log-linear INPUT ATTENUATORS to complement its peak reading meters. The input attenuators are marked in 20dB-calibrated steps, detented for extra accuracy. The attenuators provide a smooth, noise free transition from the highest to the lowest audio level. dB-calibrated input attenuators have numerous advantages: on the road, they allow predictable and repeatable setups; in commercial sound applications, they allow easy, accurate input sensitivity adjustments; in studios or discos, they let operators simultaneously adjust the level of two channels (or two programs on separate amplifiers) with precise tracking.

INPUT AND OUTPUT CONNECTIONS

INPUT CONNECTORS for each channel include one "male" and one "female" XLR connector (BALANCED) plus two parallel phone jacks (UNBALANCED). This provides the flexibility necessary for convenient bridging to another amplifier, as well as for adapter-free connection to almost any mixer.

MONAURAL OPERATION

The PC2002 and PC2002M can easily be adapted for monaural (BTL) operation by setting the rear-panel MODE switch to MONO. In the MONO mode use the channel A input connectors and channel A attenuator for level control. The "+" terminal of the speaker system is connected to the channel A "+" output terminal and the "-" terminal of the speaker system is connected to the channel B "+" output terminal. Leave the channel A and B "-" output (SPEAKER) terminals and channel B input terminals unconnected.

SPEAKER IMPEDANCE IS 16 – 32 OHMS FOR MONO MODE OPERATION.

POUR LE MODE MONAURAL — L'IMPEDANCE DES HAUT-PARLEURS EST 16 – 32 OHMS.

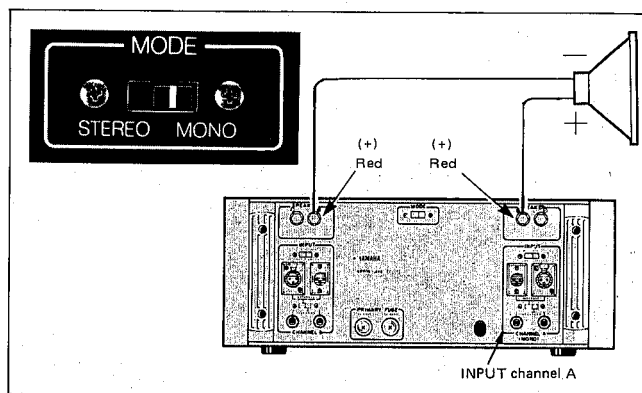

PERFORMANCE

The PC2002M's performance is as impressive as its features. At a sustained output of 240 watts into 8 ohms (for each channel), there is plenty of punch to reproduce the powerful peaks essential to clean studio monitoring. High power handling also makes the PC2002M an unbeatable choice for live rock or disco sound systems, where an amplifier can really "cook" all night long. Power alone is no virtue; the PC2002M has ultra-low distortion, less than 0.05% THD at full rated power — the kind of low distortion that is undetectable by even the most critical listeners.

A high damping factor of better than 350 at 1kHz reduces the tendency for speaker cone overshoot, giving tighter and better defined bass response. On the other end, the PC2002M's frequency response extends well beyond 50kHz, enabling it to accurately reproduce the most complex musical waveforms — even the tortuous output of today's synthesizers. However, high frequency response has not been achieved at the expense of stability; in fact, the PC2002M is rock steady. Even when connected to highly reactive multi-speaker loads, there is no tendency to shut down or "take off" into spurious oscillation.

MECHANICAL CONSIDERATIONS

The PC2002M is constructed to withstand the high "G" forces encountered on the road. Its solid front panel mounts in any standard 19-inch rack, and, for a large amplifier, the PC2002M weighs a modest 44 pounds (20.5kg).** Front panel controls and meters are recessed to avoid damage or accidental setting changes, and are further protected by a pair of sturdy carrying handles. Inside and out, the PC2002M is extremely reliable. Still, should service ever be required, the unit is designed for easy access. Massive side-mounted heat sinks are designed for efficient cooling, making fans unnecessary in all but the most severe thermal operating conditions. Four non-conductive feet ensure proper air flow when the amplifier is shelf mounted, and avoid inadvertent ground loops. Multiple protection circuits make the amplifier nearly abuse proof and eliminate the need for troublesome DC power supply fuses.

* The PC2002 does not have the Peak Reading Meters.

** The PC2002 weighs 44 pounds (20kg)

BRIEF OPERATING INSTRUCTIONS

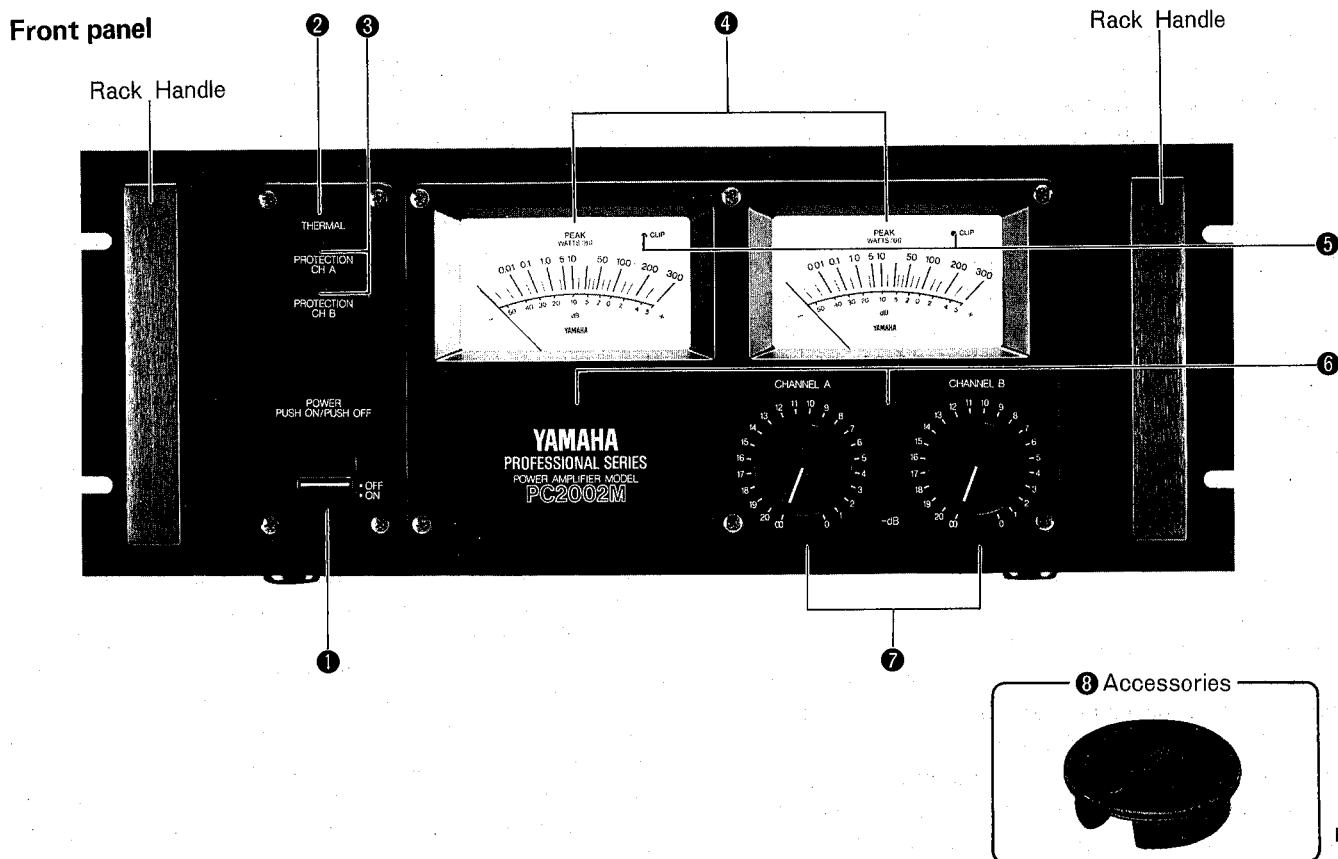

1 POWER Switch/Indicator

Pressing this switch turns power to the amplifier ON and causes the power indicator to light. Pressing the POWER switch a second time turns the unit OFF.

2 THERMAL Indicator

This indicator lights if surface temperature of the main heat sink exceeds 85 ± 5 degrees centigrade.

3 PROTECTION Indicator

Lights for approximately 4 seconds after power is switched on, indicating that the protection circuitry is active. The speaker outputs are shut off while this indicator is lit. If the protection circuitry is activated for any reason during amplifier operation, the indicator will light and the speaker outputs will be shut off. Once the cause of protection activation has been remedied normal operation will resume automatically and the protection indicator will go out.

4 PEAK Level Meters (PC2002M)

These meters have a rise time of 10 milliseconds and a fall time of 0.8 seconds. The logarithmic meter scales read directly in watts when speaker impedance is 8 ohms. A dB scale is also provided with 0 dB referenced at 100 watts.

5 CLIP Indicator

The CLIP indicators light when output distortion of the respective channel exceeds approximately 2%. This indicates that the amplifier is clipping due to excessive input signal levels.

*The PC2002 CLIP indicators are located above the input attenuators.

6 Zero Adjust (PC2002M)

A small “—” screwdriver is used to adjust the peak meter zero point.

7 Input Attenuators

The controls are detented in 21 dB steps, each step corresponding to 1 dB of attenuation except the last step. Attenuation in the fully clockwise position is 0 dB, and ∞ in the fully counterclockwise position.

8 Knob Lock Adaptors (Supplied)

The Knob Lock Adaptors prevent accidental alteration of attenuator settings once the appropriate settings have initially been made.

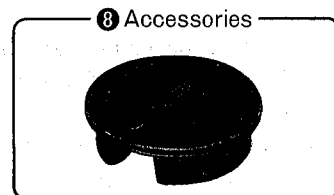
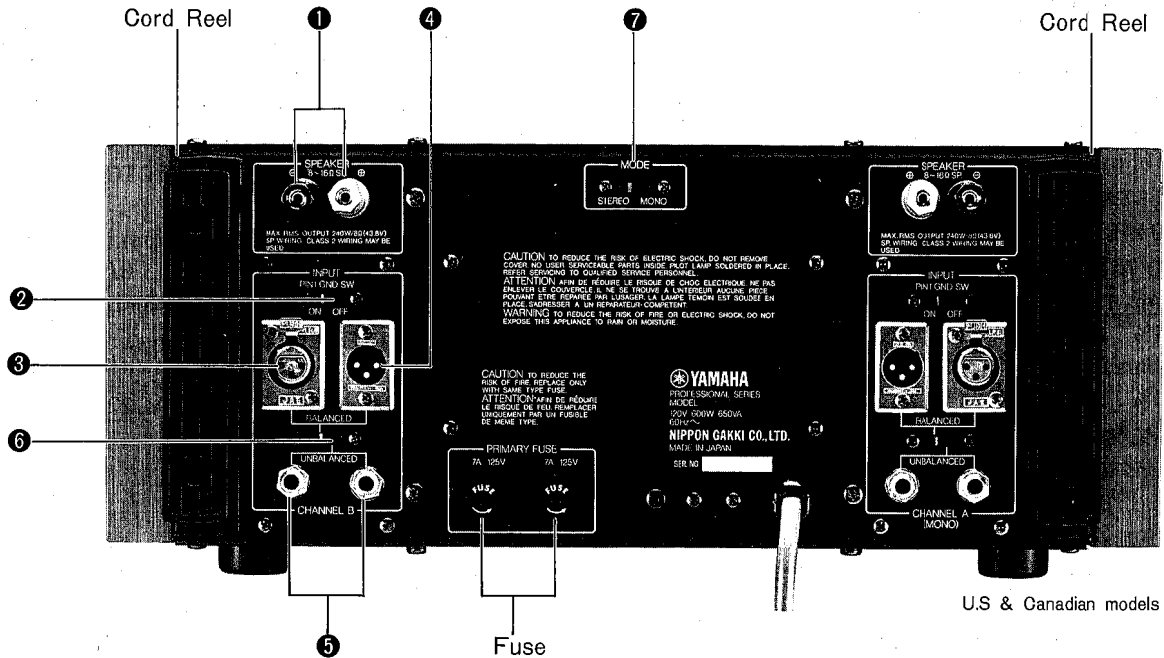
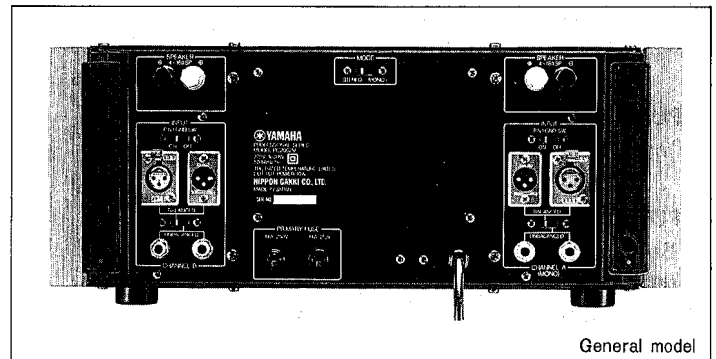

Fig. 1

Rear panel



U.S. & Canadian models



General model

Fig. 2

1 SPEAKER Output Terminals

The red SPEAKER terminal is connected to the "+" input terminal of the speaker system used and the black SPEAKER terminal is connected to the "-" speaker input terminal.

2 PIN 1 GND SW

Couples or decouples the canon connector earth line (pin 1, shield). Normally ON. In some cases where ground loops cause excessive hum, turning the ground switch OFF can interrupt the loop and reduce the hum.

3 Canon Connectors (XLR-3-31)

These connectors are generally used as inputs. Pin 1 is shield, pin 2 is hot and pin 3 cold. Compatible connectors include Canon XLR-3-12C and Switchcraft 5C-1055A.

4 Canon Connectors (XLR-3-32)

Compatible with Canon XLR-3-11C or switchcraft 5C-1056A connectors, these connectors are useful for sending the input signal to other power amplifiers.

5 Standard Phone Jacks

These jacks accept unbalanced input via standard 1/4" phone plugs. The BALANCED/UNBALANCED switch should be set to UNBALANCED when using these inputs. These jacks can also be used as send terminals.

6 BALANCED/UNBALANCED Switch

Determines which input connectors are active. In the BALANCED position, input signals are accepted via the balanced Canon connectors, and in the UNBALANCED position input is accepted via the unbalanced phone jacks.

7 MODE Selector Switch

Determines whether the amplifier is to operate in the stereo or mono (BTL) mode.

GENERAL SPECIFICATIONS

POWER OUTPUT LEVEL

Continuous average sine wave power with less than 0.05% THD, 20 Hz to 20 kHz.

Stereo, 8 ohms	240W + 240W
Mono, 16 ohms	480W
Mono, 8 ohms	700W

FREQUENCY RESPONSE

10 Hz to 50 kHz, 8 ohms, 1W	+0dB -0.5dB
-----------------------------	----------------

POWER BAND WIDTH

Stereo 8 ohms 120W	
THD 0.1%	10 Hz to 100 kHz
Mono 16 ohms 240W	
THD 0.1%	10 Hz to 100 kHz

TOTAL HARMONIC DISTORTION

Stereo 8 ohms 120W	
1 kHz	Less than 0.003%
Mono 16 ohms 240W	
20 to 20 kHz	Less than 0.007%
Mono 8 ohms 350W	
20 to 20 kHz	Less than 0.01%

INTER MODULATION DISTORTION

70 Hz 7kHz mixed 4 : 1	
Stereo 8 ohms, 120W	Less than 0.01%
Mono 16 ohms, 240W	Less than 0.01%

INPUT SENSITIVITY

Input level which produces 100W output into 8 ohms	
	0 dB (0.775 V rms)

INPUT IMPEDANCE

Balanced and unbalanced inputs, maximum attenuator setting	25 kohms
--	----------

8 OHM DAMPING FACTOR

1 kHz	Greater than 350
20 to 20 kHz	Greater than 200

S/N RATIO

Input shorted at @12.47 kHz	110 dB
Input shorted at @IHFA	115 dB

SLEW RATE

Stereo 8 ohms	60 V/ μ sec
Mono 16 ohms	90 V/ μ sec

CHANNEL SEPARATION

8 ohms 120W	
1 kHz	95 dB
8 ohms 120W	
20 to 20 kHz	80 dB

RELAY MUTING TIME

From power on	4 ⁺² ₋₁ sec
---------------	-----------------------------------

INDICATORS

Power ON	LED
Protection (Relay OFF)	LED
Thermal Overload (85 \pm 5 degrees C)	LED
Clipping (2% THD)	LED
Peak Power Meters (PC2002M only)	
... -50 dB to +50 dB range 0 dB = 100W into 8 ohms	

FRONT PANEL CONTROLS

Power Switch	Push-ON/Push-OFF
Input Attenuators (one per channel)	
	22 detent positions in -1 dB steps (0, -1, -2 ... -20, ∞)

REAR PANEL CONTROLS/CONNECTORS

Mode switch	STEREO/MONO
Pin 1 GND Switch (XLR connectors)	ON/OFF
Balance/Unbalance Switch	BALANCED (XLR)/ UNBALANCED (PHONE)

POWER REQUIREMENTS

U.S. & CANADIAN models	AC120V, 60 Hz
GENERAL Model	AC220/240V, 50/60 Hz

POWER CONSUMPTION

U.S. & CANADIAN models	700 W
GENERAL model	1600 W

DIMENSIONS

(W x D x H)	480 x 413 x 183 mm (18-7/8" x 16-1/4" x 7-1/4")
-------------	--

WEIGHT

PC2002	20 kg (44 pounds)
PC2002M	20.5 kg (45 pounds)

NOTE: U.S. & CANADIAN Models must be operated into 8 ohms in stereo mode and 16 ohms in mono mode in accordance with safety regulations.

All specifications subject to change without notice.

PERFORMANCE GRAPHS

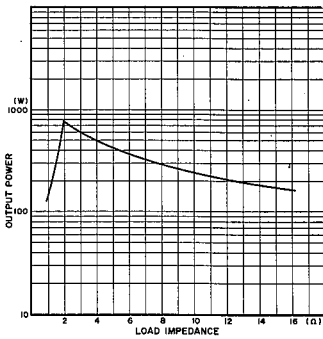

Fig. 3

LOAD IMPEDANCE VS OUTPUT POWER
 THD 0.05% Mode STEREO
 Single Channel Driven

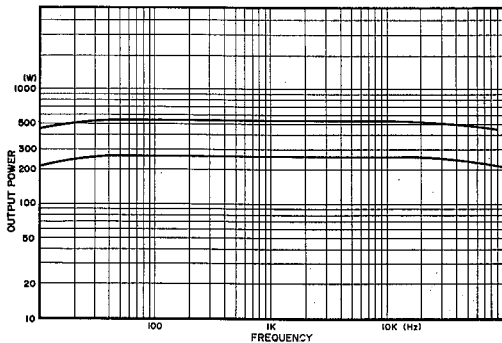

Fig. 4

POWER BAND WIDTH
 ① Load Impedance 16Ω ② Load Impedance 8Ω
 THD 0.05% THD 0.05%
 Mode MONO Mode STEREO
 Both Channel Driven

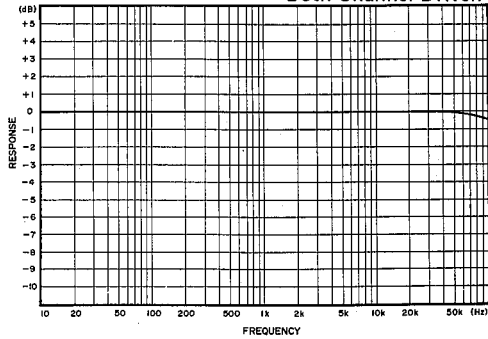

Fig. 5

FREQUENCY RESPONSE
 ① Load Impedance 16Ω ② Load Impedance 8Ω
 Power Output = 1W at 1kHz Power Output = 1W at 1kHz
 Mode MONO Mode STEREO
 Channel A Channel A & B
 (UNBAL INPUT) (UNBAL INPUT)

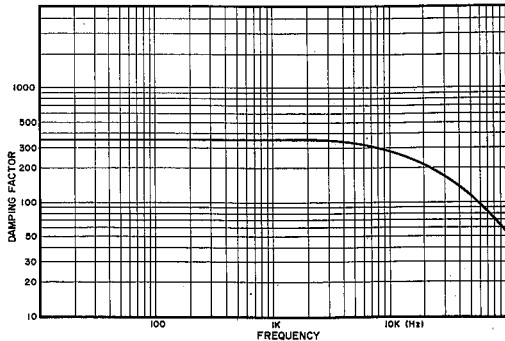

Fig. 6

DAMPING FACTOR
 Load Impedance 8Ω
 Mode STEREO

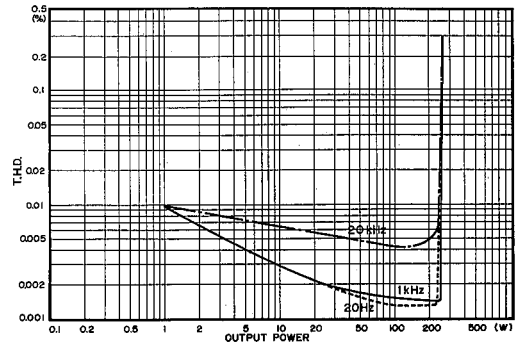

Fig. 7

T.H. DISTORTION
 Load Impedance 8Ω
 Mode STEREO
 Both Channel Driven
 IN/OUT Channel A

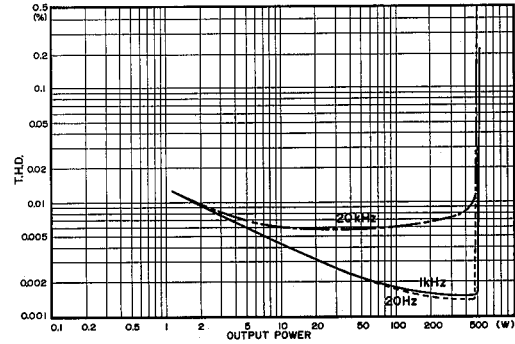

Fig. 8

T.H. DISTORTION
 Load Impedance 16Ω
 Mode MONO

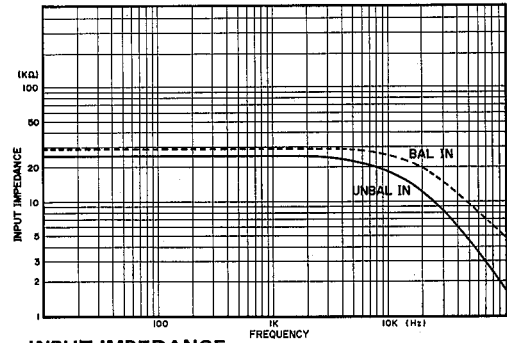

Fig. 9

INPUT IMPEDANCE
 Mode STEREO

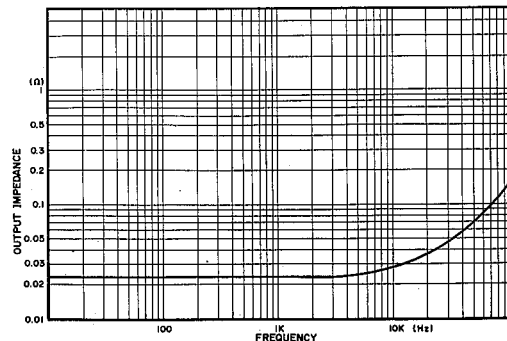

Fig. 10

OUTPUT IMPEDANCE
 Load Impedance 8Ω
 Mode STEREO

The following are actual oscilloscope photographs made by an independent testing laboratory.

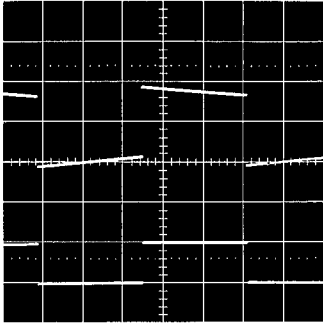

Fig. 11

20 Hz Square-Wave Response

Remarkably accurate response at this low frequency ensures that bass reproduction will be tight and clean.

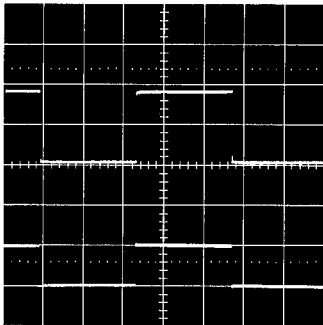

Fig. 12

1 kHz Square-Wave Response

Flawless midrange response is immediately evident in this scope trace. There is no unnatural response rolloff, ringing or overshoot to interfere with music reproduction.

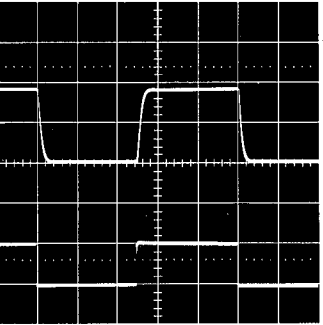

Fig. 13

20 kHz Square-Wave Response

Although 20,000 Hz is well beyond the range of human hearing, the response accuracy shown here means that upper-range harmonics vital to natural reproduction will be properly reproduced.

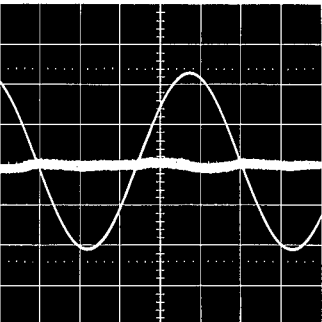

Fig. 14

Total Harmonic Distortion with a 1 kHz Sine Wave Signal

The distortion components shown in this trace are actually a mere 0.0014%. It's this type of low-distortion performance that makes the PC2002 and PC2002M ideal for demanding professional applications.

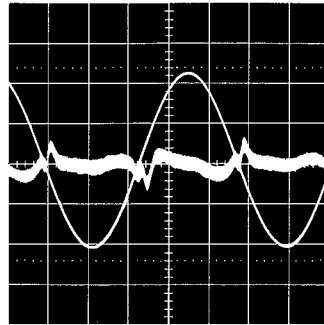

Fig. 15

Total Harmonic Distortion with a 20 kHz Sine Wave Signal
Although the amp is delivering 240 watts (mono, BTL) output power continuously at 20,000 Hz, harmonic distortion is no more than 0.0036%. That means clean, transparent highs, even on high-level peaks.

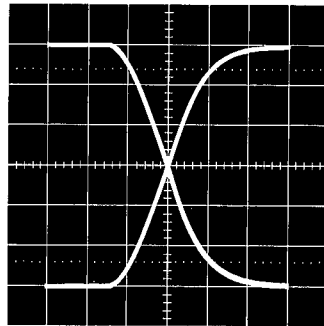

Fig. 16

Slew Rate and Rise Time

Stereo mode, 8 ohm load $f=2$ kHz : $60V/\mu S$ slew rate

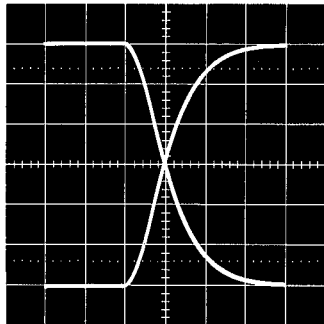

Fig. 17

Mono mode, 16 ohm load, $f=2$ kHz: $90V/\mu S$ slew rate.

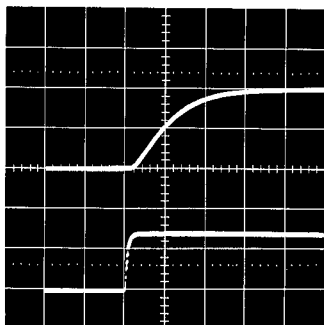

Fig. 18

Stereo mode, 8 ohm load, $f=1$ kHz: $1.8\mu S$ rise time.

Here's your guarantee of exceptional transient response. Extremely high slew rate and fast rise time mean precise signal reproduction.

[$1\mu S$ /horizontal division, 20 V/vertical division]

A DISCUSSION OF SPECIFICATIONS

POWER OUTPUT

Types of Power Ratings

Peak power refers to the maximum undistorted power output of an amplifier. Most amplifiers cannot sustain their peak power ratings for long periods of time without external cooling fans. Because there are many different methods of rating an amplifier's peak power, it is hard to objectively compare the peak power ratings of two amplifiers. The peak power rating is primarily useful for determining an amplifier's ability to reproduce the peaks and transients in a musical program, peaks which may be 20dB or more above the average power level. The ability to accurately reproduce these high power peaks in a musical program is one of the most important advantages of the PC2002M as compared to a smaller power amplifier.

"RMS" power is actually a misnomer for *average power*. Average power is usually measured with a sine wave input signal, and is equal to the amplifier's RMS output voltage squared and then divided by the load impedance. Because RMS voltage is used in the formula, the resulting power rating is commonly called "RMS power". While it means the same as "RMS power", to be more accurate, the PC2002M is rated in watts of "continuous average sine wave power".

Since the PC2002M is a *professional* power amplifier, not sold for home hi-fi use, it is not required to meet the power rating standard set by the FTC (Federal Trade Commission), a standard meant for *consumer* power amplifiers. However, the PC2002M is measured under severe conditions which simulate the most demanding *professional* usage. Thus, the PC2002M would easily meet the FTC ratings for consumer amplifiers. In addition, the PC2002M user has the benefits of professional features and reliability.

Reasons for a High Power Amplifier

An interesting characteristic of the human ear is described by the "Webe-Fechner" law. In its general form, the law applies to all our senses:

The amount of additional stimulus needed to produce a perceptible change is dependent on the amount of stimulus already present.

In mathematical terms, the Weber-Fechner law suggests that the human ear responds to changes in sound level in a logarithmic manner. More simply this means that *for a sound to seem twice as loud*, it requires approximately *ten times as much acoustic power* (and therefore ten times as much amplifier power). Thus, the PC2002M's high power output capabilities are extremely valuable.

One of the other benefits of high power output is the ability of the amplifier to easily reproduce high peak power transients (which may be 100 times the average program power, or even more).

DISTORTION (Refer to Figures 7 and 8.)

The PC2002M is designed to have the lowest possible distortion. There are many different forms of distortion, however, and comprehensive distortion ratings offer a means to compare the performance of different amplifiers.

Harmonic Distortion, is characterized by the appearance at the amplifier output of *harmonics* of the input waveform which were not present in the *original* input waveform. *Total Harmonic Distortion*, or T.H.D. is the sum total of all of these unwanted harmonics expressed as a percentage of the total signal.

Harmonic distortion, in an amplifier, can be created in any of several ways. The T.H.D. rating of a power amplifier refers to creation of unwanted harmonics by the amplifier during "linear" operation (normal input and output levels, impedances, etc.). Harmonic distortion is also created by "clipping", a form of "non-linear" operation, which occurs when the signal level at an amplifier's input is high enough to drive the amplifier beyond its rated maximum output. The amplifier, in attempting to reproduce this signal, reaches its maximum output voltage swing before it reproduces the top of the signal waveforms. Since the output voltage cannot rise any farther, the tops of the waveform are "squared off", or clipped. Clipping distortion adds odd upper harmonics (3rd harmonic, 5th, etc.) to the original signal. (Input clipping would be similar, where the input stage of the amplifier is overdriven by a high level input signal.) The PC2002M has wide input headroom and extremely high peak power output capabilities (headroom) to help avoid the problems of clipping distortion.

Another form of harmonic distortion that occurs in some power amplifiers is called *crossover distortion*. * Crossover distortion can be caused by improper bias in the output transistors of an amplifier. The *amount* of crossover distortion stays the same whether the signal is large or small, so the *percentage* of distortion goes down as the signal level goes *up*. Thus, an amplifier with crossover distortion may sound relatively distortion free at high output levels, yet sound "fuzzy" at low levels. Some amplifiers have internal adjustments which enable a service technician to control the amount of output transistor bias, and therefore control the distortion.

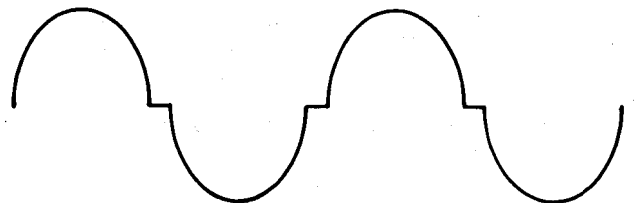

Fig. 19A — Large Amplitude Sine Wave with Crossover (notch) Distortion.

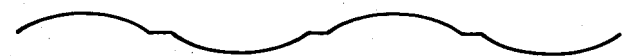

Fig. 19B — Smaller Amplitude Sine Wave with same amount (higher %) of Crossover (notch) Distortion.

*"Crossover", in this case, refers to the transition between the positive half and the negative half of the output voltage waveform in a "push-pull" class B or AB power amplifier: it has nothing to do with the crossover used to divide frequencies in a speaker system. See Figure 19.

Intermodulation Distortion, or I.M. is characterized by the appearance in the output waveform of frequencies that are equal to sums and differences of integral multiples of two or more of the frequencies present in the input signal. The difference between intermodulation distortion and harmonic distortion is that two or more different frequencies must be present to produce intermodulation distortion (only one frequency is needed for harmonic distortion to appear), and that intermodulation distortion products may not be harmonically related to the original frequencies. Like its harmonic distortion figure, the intermodulation distortion in the PC2002M is low enough to be virtually inaudible even in the most critical situations.

FREQUENCY RESPONSE (Refer to Figure 5)

The *frequency response* of the PC2002M describes the variation in its output signal level with frequency when the input signal is held constant. The extremely "flat" frequency response curve of the PC2002M is an indication of its overall quality and its ability to respond to upper and lower harmonics of signals all the way to the extremes of the audio spectrum.

Because extreme stability is necessary for some types of commercial sound applications, some manufacturers restrict frequency response or allow relatively high distortion in return for increased amplifier stability. The PC2002M, on the other hand, has excellent frequency response and ultra-low distortion, yet is inherently stable under the most difficult loads, even in the "mono" mode.

The frequency response of the PC2002M has been intentionally limited, however, at very low frequencies (sub-audio). Because of this, severe low frequency transients, or DC offset, appearing at the input to the PC2002M are unlikely to damage a speaker load. Other amplifiers which are DC coupled throughout may have a "flatter" sub-audio frequency response, but this makes them capable of amplifying dangerous DC input voltage or sub-audio transients and delivering them (at high power) to a speaker.

POWER BANDWIDTH (Refer to Figure 4)

The *power bandwidth* of the PC2002M is a measure of its ability to produce high power output over a wide frequency range. The limits of the power bandwidth are those points where the PC2002M can only produce 1/2 the power that it can produce at 1000Hz. While the frequency response is measured at relatively low power output (1 watt), the power bandwidth is measured at the PC2002M's full power output (before clipping). The power bandwidth of the PC2002M is quite "flat", and extends to 100kHz, well beyond the limits of the audio spectrum.

The wide power bandwidth of the PC2002M means that it can reproduce high level upper harmonics of a signal as easily as it can reproduce mid-range fundamentals. It means that you get full power performance from the PC2002M over the entire audio frequency spectrum. This is especially important when the amplifier is called upon to reproduce musical material with high energy over a wide frequency range, such as rock and roll.

CHANNEL SEPARATION

This specification indicates the output from one channel when a signal is fed to the other channel. The PC2002M's channel separation is very good, which means that even critical stereo programs will be unaffected by crosstalk between channels.

HUM AND NOISE

Hum or noise from a power amplifier disrupts a program, and is irritating to a listener. Hum and noise could be considered a form of distortion. The PC2002M's hum and noise are so low that they are completely inaudible under any normal listening circumstances.

SLEW RATE

Slew rate is a measure of a power amplifier's ability to follow a fast rising waveform at higher frequencies and higher power outputs than the rise time measurement.

It might seem reasonable to assume that the fastest slew rate for an audio waveform occurs at 20kHz. However, this is not the case. When one frequency is superimposed upon another, the combined waveform has a slew rate that is greater than the slew rate of either signal by itself. The actual value of the slew rate of one of these waveforms (or any waveform) depends not only on the frequency, but on the amplitude of the waveform as well. Thus, the criteria for a good slew rate specification, which indicates that an amplifier can reproduce these combination waveforms, varies with the maximum power output capability of the amplifier. The higher the power, the higher the required slew rate. With a 60 volts/microsecond slew rate, the PC2002M can easily reproduce even the most extreme audio waveforms at its full power output.

INPUT IMPEDANCE

The *input impedance* of the PC2002M is high enough to allow it to be used with most semi-pro devices, or to be used as a "bridging" load for a 600-ohm source.

INPUT SENSITIVITY

The PC2002M's *input sensitivity* indicates the input drive voltage needed for the PC2002M to produce its rated output of 240 watts into 8 ohms (input attenuators are adjusted to maximum clockwise rotation for minimum attenuation).

PROTECTION CIRCUITS AND THERMAL SPECIFICATIONS

The PC2002M is one of the safest amplifiers you can find. It incorporates multiple protection circuits—transient suppression, current limiting, short circuit and overload protection, dc offset sensing with relay disconnect, powered transformer overtemperature sensing with auto shutdown—to prevent speaker damage in the event of an amplifier failure, and to prevent amplifier damage in the event of a load or cable problem. Because the circuits function automatically, front panel LEDs are installed to inform the operator of overload protection status. A thermal LED also warns of excessive heat sink temperature.

GAIN

Gain is the ratio of the PC2002M's output voltage to its input voltage. Maximum gain occurs when the input attenuators are set for minimum attenuation. If the input and output voltage are specified in dB, the voltage gain is equal to the difference of the two dB numbers. As stated under **INPUT SENSITIVITY**, an input voltage of 0dB (0.775 volts) produces an output power of 100 watts into an 8-ohm load.

OUTPUT IMPEDANCE (Refer to Figure 10)

The *output impedance* of the PC2002M is extremely low. Thus, within its operating limits, the PC2002M is a good approximation of a perfect voltage source and will deliver increasing power levels into lower impedance loads in a linear fashion according to Ohm's law.

DAMPING FACTOR

Damping factor is a term that is derived by dividing the load impedance (speaker or other load) by the amplifier's output impedance. Thus, a high damping factor indicates a low output impedance at as specified load.

The cone/voice-coil assembly of a loudspeaker gains inertia during its back and forth movements. This inertia can cause it to "overshoot", that is, to continue movement in one direction, even when the amplifier is trying to pull it back in the other direction. An amplifier with a low output impedance can "damp" (reduce) unwanted loudspeaker motions, as explained below.

During the "overshoot" movement, the voice coil of the loudspeaker interacts with the loudspeaker's magnetic assembly to produce a voltage called "back E.M.F." (electro-motive force). This action is similar to the operation of a dynamic microphone. If the amplifier's output impedance is low, this "back E.M.F." voltage is shunted through the amplifier's output circuits to ground, and back to the voice coil. Since the path from the voice coil, through the amplifier's output circuits, and back to the voice coil is a complete circuit, a current flows in the voice coil. This current, causes the voice coil to act like an electro-magnet; the electro-magnet (voice coil) interacts with the magnetic assembly of the loudspeaker, and the unwanted overshoot is reduced (a magnetic braking action).

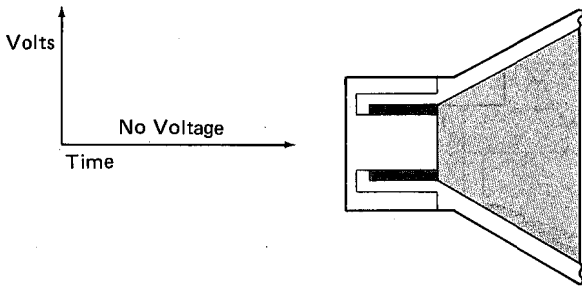

Fig. 20A — Speaker Cone at Rest

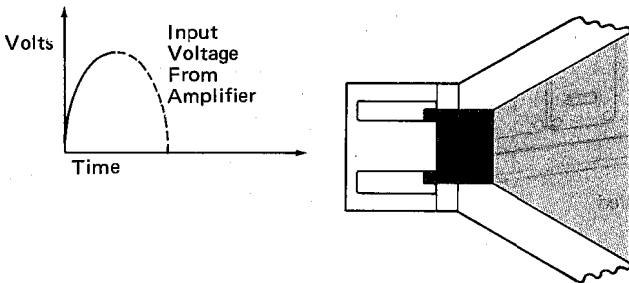

Fig. 20B — Speaker Cone moved outward by Positive-Going Voltage from Amplifier.

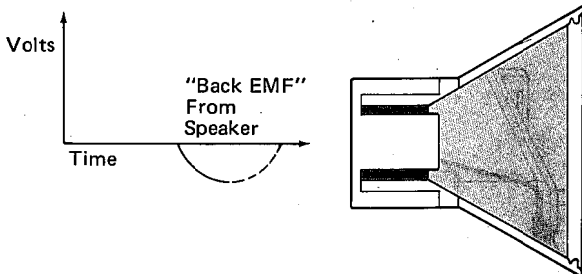

Fig. 20C — Voltage from Amplifier has dropped to Zero but Speaker Cone has moved back PAST its rest position (overshoot) and is producing a voltage of its own: "Back EMF".

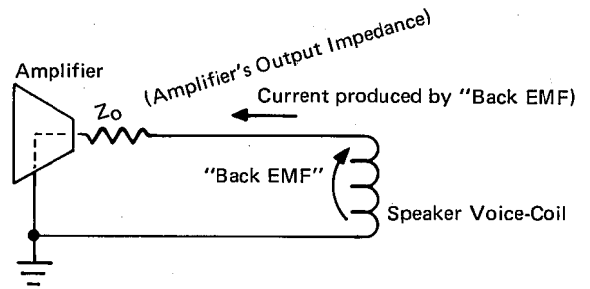

Fig. 21 — Current produced by "Back EMF" follows path through Amplifier's Output Impedance to speaker-coil.

If the amplifier's output impedance is low (considerably less than the impedance of the loudspeaker voice coil), this damping action is limited only by the resistance of the voice coil combined with the resistance of the speaker lead wires. While the value of a high damping factor in reducing cone overshoot is disputed, the PC2002M's high damping factor is evidence of good overall engineering design.

MOUNTING

PHYSICAL MOUNTING

Shelf Mounting

The PC2002M can be used on any surface, so long as there is adequate ventilation. Do not remove the PC2002M's feet, since this would prevent air flow below the amplifier.

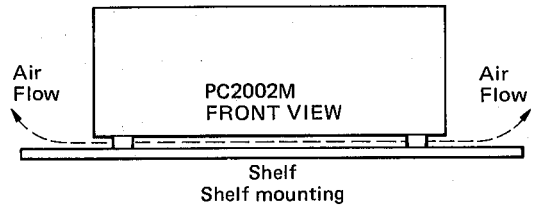

Permanent Installation Rack Mounting

Mount the PC2002M in any standard 19" electronic equipment rack as shown to the right. Leave adequate space between the PC2002M and other devices in the rack for ventilation, and for expected cabling. Cooling fans may be required when the PC2002M must produce extremely high average power output, or when it is located in a high temperature environment, such as a closed outdoor building in direct sunlight.

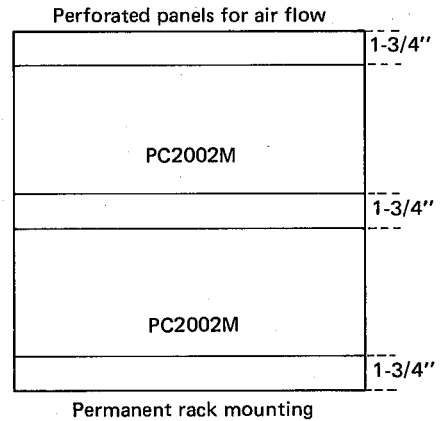

Rack Mounting for Portable Usage

Road cases must be durable enough to survive heavy cartage, and airline travel. Brace the rear of the PC2002M, and if the road case is small and ventilation is constricted, install cooling fans. One possible design is shown in Figure 22.

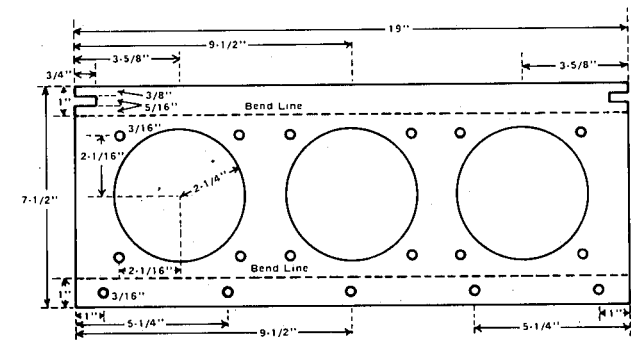

Front fan panel view before folding.

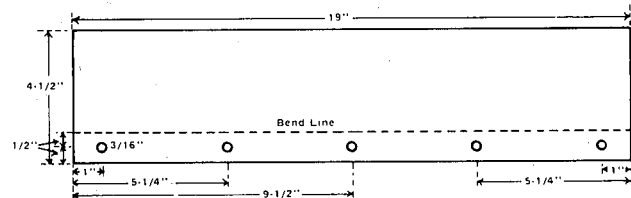

Rear fan air containment panel front view, before folding.

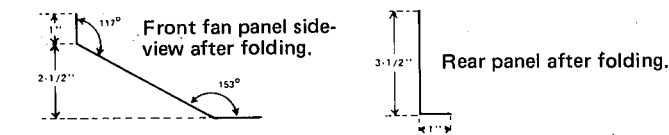

NOTE: Brace length assumes a front-back rack depth of 15".

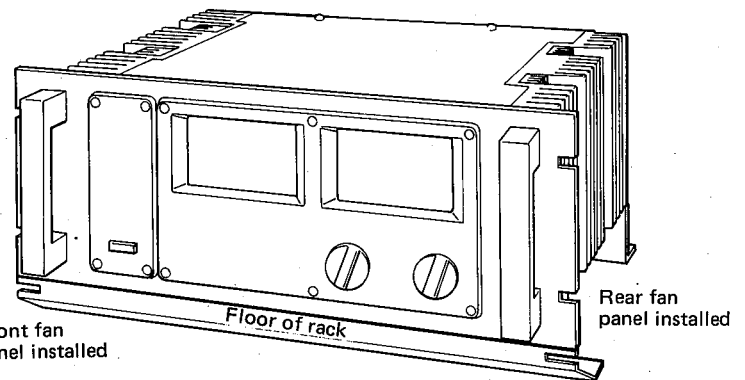
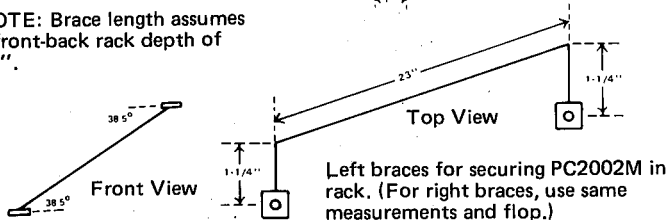
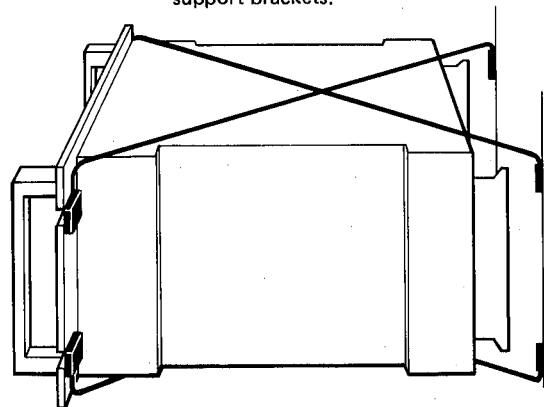

Fig. 22 — PC2002M with Cooling Fans

Extra rack strips mounted in back of cabinet for mounting special support brackets.



PC2002M mounted in rack showing support brackets made from bent pieces of 1/8" steel rod with nuts welded to their ends.

BLOCK DIAGRAM

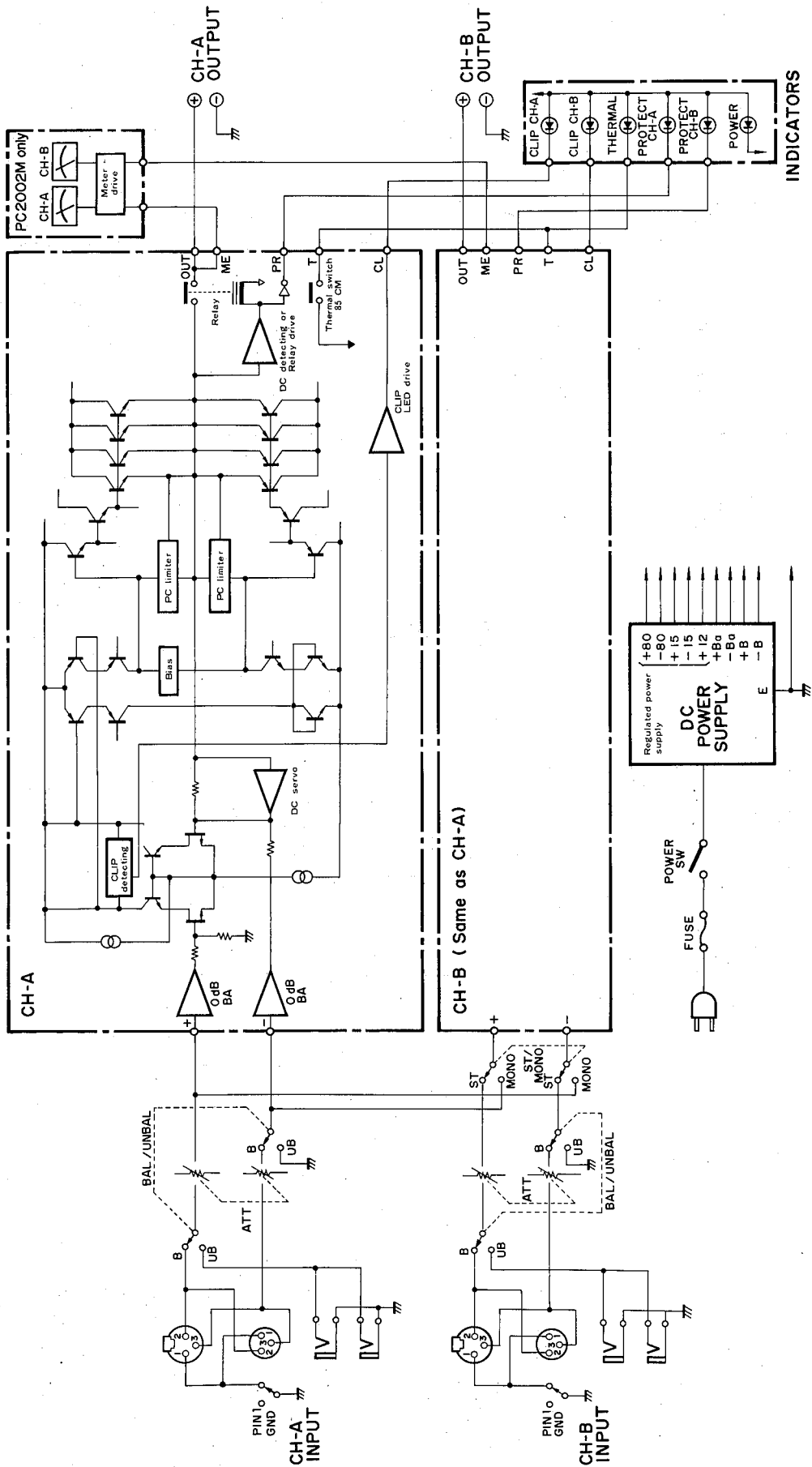

DIMENSIONS

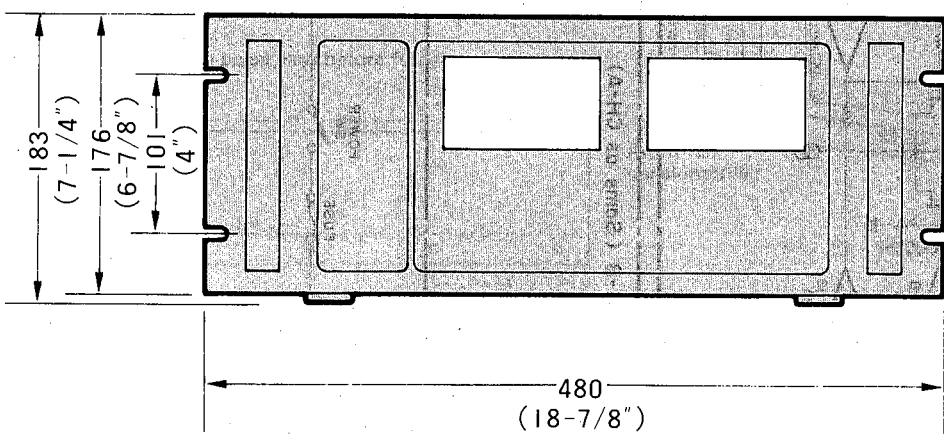
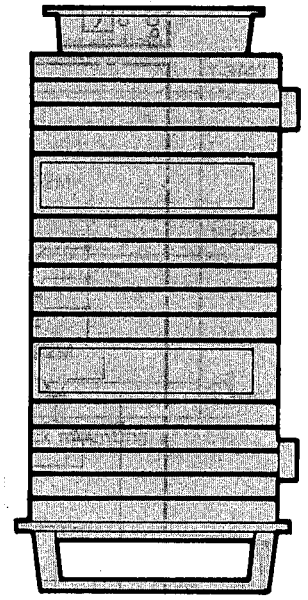
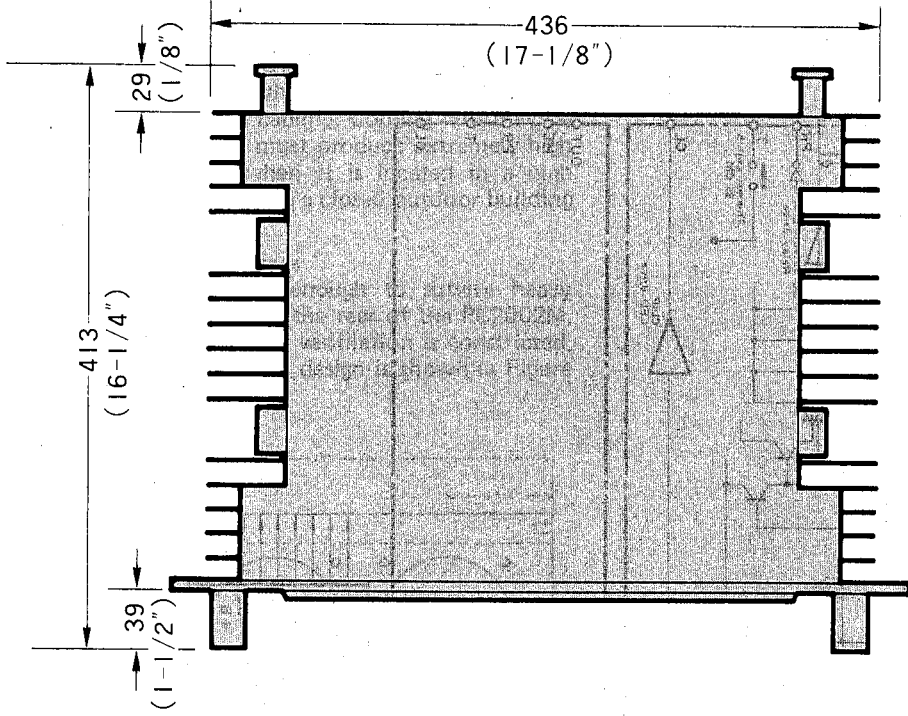

Weight: PC2002 44 lbs (20.0 kg)
PC2002M 45 lbs (20.5 kg)

IMPORTANT NOTICE FOR THE UNITED KINGDOM

Connecting the Plug and Cord

IMPORTANT. The wires in this mains lead are coloured in accordance with the following code:

BLUE : NEUTRAL

BROWN : LIVE

As the colours of the wires in the mains lead of this apparatus may not correspond with the coloured markings identifying the terminals in your plug proceed as follows:

The wire which is coloured **BLUE** must be connected to the terminal which is marked with the letter **N** or coloured **BLACK**.

The wire which is coloured **BROWN** must be connected to the terminal which is marked with the letter **L** or coloured **RED**.

SERVICE

The PC2002, PC2002M are supported by Yamaha's worldwide network of factory trained and qualified dealer service personnel. In the event of a problem, contact your nearest Yamaha dealer.

YAMAHA

YAMAHA CORPORATION
P.O.Box 1, Hamamatsu, Japan